

**ENGINEERING EVALUATION
AND COST ANALYSIS
FOR BIOSLURPER INITIATIVE (A005)**

FINAL

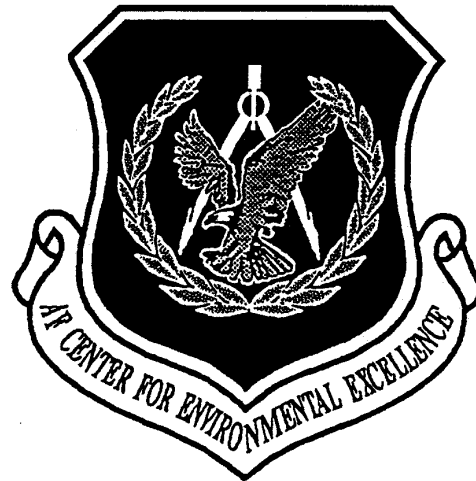

PREPARED FOR:

**AIR FORCE CENTER FOR ENVIRONMENTAL EXCELLENCE
TECHNOLOGY TRANSFER DIVISION
(AFCEE/ERT)
BROOKS AFB, TEXAS 78235-5357**

25 MARCH 1997

**ENGINEERING EVALUATION AND COST ANALYSIS
FOR BIOSLURPER INITIATIVE (A005)**

CONTRACT NO. F41624-94-C-8012

to

**U.S. Air Force Center for Environmental Excellence
Technology Transfer Division
(AFCEE/ERT)
8001 Arnold Drive
Building 642
Brooks AFB, Texas 78235**

25 March 1997

by

**BATTELLE
505 King Avenue
Columbus, Ohio 43201**

This report is a work prepared for the United States Government by Battelle. In no event shall either the United States Government or Battelle have any responsibility or liability for any consequences of any use, misuse, inability to use, or reliance upon the information contained herein, nor does either warrant or otherwise represent in any way the accuracy, adequacy, efficacy, or applicability of the contents hereof.

TABLE OF CONTENTS

LIST OF TABLES	iv
LIST OF FIGURES.....	v
ACRONYMS AND ABBREVIATIONS	vii
EXECUTIVE SUMMARY.....	ix
1.0 INTRODUCTION.....	1
1.1 Objectives	1
1.2 Organization of Report	2
2.0 SUMMARY OF TESTING PROGRAM RESULTS.....	3
3.0 SITE CLEANUP STANDARDS	8
3.1 Applicable or Relevant and Appropriate Requirements	8
3.1.1 Chemical-Specific ARARs	9
3.1.2 Location-Specific ARARs	10
3.1.3 Action-Specific ARARs	12
3.2 Summary of Major Federal Statutes and Regulations	13
3.2.1 Resource Conservation and Recovery Act Hazardous Waste Regulations	13
3.2.2 Resource Conservation and Recovery Act Underground Storage Tank Regulations	13
3.2.3 Clean Air Act of 1990 (42 USC 7401-7642).....	15
3.2.4 Clean Water Act (33 USC 1251-1376).....	15
3.2.5 Safe Drinking Water Act (40 USC 300)	15
3.2.6 U.S. Water Quality Criteria.....	16
3.3 Remedial Action Objectives	16
3.4 Description of Media Requiring Cleanup.....	17
3.4.1 LNAPL Chemical Properties	17
3.4.2 LNAPL Environmental Fate and Transport.....	18
4.0 PRESCREENING OF TECHNOLOGIES	22
4.1 LNAPL Extraction Technologies	22
4.1.1 Skimming.....	26
4.1.2 Single-and Dual-Pump Drawdown.....	27
4.2 Thermally Enhanced Recovery Technologies	27
4.2.1 Hot Water Flooding.....	27
4.2.2 Steam/Hot Air Injection.....	29
4.2.3 Radiofrequency Heating	31
4.3 Solution Delivery and Recovery Technologies	33
4.4 Air Injection and Extraction Technologies	34
4.4.1 Air Sparging	36
4.4.2 Soil Vapor Extraction.....	39
4.5 Biotreatment Technologies	41
4.5.1 Bioventing.....	42
4.5.2 In Situ Bioremediation.....	42
4.6 Combined Mechanism Technologies.....	45
4.7 Intrinsic Remediation.....	47

TABLE OF CONTENTS
(Continued)

4.8	The "No Action" Alternative	47
4.9	Results of the Technology Screening	47
5.0	LNAPL RECOVERY TECHNOLOGY DESCRIPTION AND COST ESTIMATE	49
5.1	Skimming	53
5.1.1	Extraction Wells	53
5.1.2	Fluid Collection System	53
5.2.3	Fluid-Handling System	56
5.2	Single- and Dual-Pump Drawdown	56
5.2.1	Single-Pump Drawdown	56
5.2.2	Dual-Pump Drawdown	59
5.3	Bioslurping	62
5.3.1	Extraction Wells	62
5.3.2	Fluid Collection System	62
5.3.3	Fluid-Handling System	62
5.3.4	Emulsion Treatment Options	65
5.3.5	Off-Gas Treatment Options	65
6.0	LNAPL RECOVERY TECHNOLOGY EVALUATION PROCESS	75
6.1	Effectiveness	76
6.2	Implementability	78
6.3	Cost	78
6.4	Other Factors	80
7.0	SUMMARY AND CONCLUSIONS	81
8.0	REFERENCES	81

LIST OF TABLES

Table ES-1.	Total Costs for 6 Months of Operation with Each Remedial Alternative	xi
Table ES-2.	Comparison of Unit Cost for LNAPL Recovery	xii
Table 2-1.	Bioslurper Initiative Testing Schedules	4
Table 2-2.	Summary of Characteristics at Bioslurper Initiative Test Sites	5
Table 2-3.	Summary of Performance Results at Bioslurper Initiative Sites	6
Table 3-1.	Review of Potential Chemical-Specific ARARs	9
Table 3-2.	Review of Potential Location-Specific ARARs	10
Table 3-3.	Review of Potential Action-Specific ARARs	12
Table 3-4.	Properties of Example Components of Fuel and Waste Oils	19
Table 4-1.	Screening Comments for LNAPL Recovery/Remediation Technologies	23
Table 4-2.	Summary of Reasons for Not Retaining Technologies for Detailed Evaluation	48
Table 5-1.	Comparison of LNAPL Recovery Rates for Skimming, Pumping, and Bioslurping	50

TABLE OF CONTENTS
(Continued)

Table 5-2.	Comparison of Groundwater Removal Rates for Drawdown Pumping and Bioslurping.....	51
Table 5-3.	Ratio of Groundwater Removal Rate to LNAPL Recovery Rate for Pumping and Bioslurping.....	52
Table 5-4.	Skimming System Cost Estimate.....	55
Table 5-5.	Single-Pump Drawdown System Cost Estimate.....	58
Table 5-6.	Dual-Pump Drawdown System Cost Estimate.....	61
Table 5-7.	Bioslurper System Cost Estimate.....	64
Table 5-8.	Estimated Costs for Off-Gas Treatment by Respiration.....	68
Table 5-9.	Estimated Costs for Off-Gas Treatment with Granular Activated Carbon.....	69
Table 5-10.	Estimated Costs for Off-Gas Treatment with Catalytic Incineration.....	71
Table 5-11.	Capacities and Costs of Internal Combustion Engines for Off-Gas Treatment.....	74
Table 5-12.	Estimated Costs for Off-Gas Treatment in an Internal Combustion Engine.....	75
Table 6-1.	Total Costs for 6 Months of Operation with Each Remedial Alternative.....	78
Table 6-2.	Cost Savings for Bioslurping Compared to Conventional LNAPL Recovery Technologies.....	79
Table 6-3.	Comparison of Unit Cost for LNAPL Recovery.....	80

LIST OF FIGURES

Figure 2-1.	Contaminant Distribution at a Typical LNAPL Site.....	3
Figure 3-1.	Effects of Physical and Chemical Properties of Hydrocarbons on Environmental Transport Mechanisms.....	20
Figure 4-1.	Illustration of Hot Water Flooding Technology Implementation.....	28
Figure 4-2.	Illustration of Steam Injection Technology Implementation.....	30
Figure 4-3.	Illustration of Radiofrequency Heating Technology Implementation.....	32
Figure 4-4.	Illustration of Soil Flushing Technology Implementation.....	35
Figure 4-5.	Illustration of In-Well Air Stripping Technology Implementation.....	37
Figure 4-6.	Illustration of In Situ Air Sparging Technology Implementation.....	38
Figure 4-7.	Illustration of Combined Groundwater Removal and Soil Vapor Extraction Technology Implementation.....	40
Figure 4-8.	Illustration of Bioventing Technology Implementation.....	43
Figure 4-9.	Illustration of In Situ Bioremediation Technology Implementation.....	44
Figure 5-1.	Schematic Diagram of a Skimming Drawdown System.....	54
Figure 5-2.	Schematic Diagram of a Single-Pump Drawdown System.....	57
Figure 5-3.	Schematic Diagram of a Dual-Pump Drawdown System.....	60
Figure 5-4.	Schematic Diagram of a Bioslurper System.....	63
Figure 5-5.	Bioslurper System Filter Tank.....	66

ACRONYMS AND ABBREVIATIONS

AFB	Air Force Base
ACFEE	U.S. Air Force Center for Environmental Excellence
AFS	Air Force Station
ARARs	applicable or relevant and appropriate requirements
BDAT	best demonstrated available technology
BTEX	benzene, toluene, ethylbenzene, and xylenes
CAA	Clean Air Act
CID	cubic inch displacement
CERCLA	Comprehensive Environmental Response, Compensation, and Liability Act of 1980 (42 USC Sections 9601 et seq., also known as Superfund)
CFR	<i>Code for Federal Regulations</i>
DNA	Defense Nuclear Agency
DNAPL	dense, nonaqueous-phase liquid
EE/CA	engineering evaluation and cost analysis
ESA	Endangered Species Act
EV	engine vacuum
EX	extraction well
FCC	Federal Communications Commission
FIFRA	Federal Insecticide, Fungicide, and Rodenticide Act
FONSI	finding of no significant impact
FR	<i>Federal Register</i>
GAC	granular activated carbon
HAP	hazardous air pollutant
IAS	in situ air sparging
ICE	internal combustion engine
IRP	Installation Restoration Program
JP	jet propulsion (fuel)
LDR	land disposal restriction
LEL	lower explosive limit
LNAPL	light, nonaqueous-phase liquid
MACT	Maximum Achievable Control Technology
MCB	Marine Corps Base
MCL	maximum contaminant level
MCLG	maximum contaminant level goal
MW	monitoring well

NAAQS	National Ambient Air Quality Standards
NAPL	nonaqueous-phase liquid
NCP	National Contingency Plan
NEPA	National Environmental Policy Act
NHPA	National Historical Preservation Act
NO _x	nitrogen oxides
NPDES	National Pollutant Discharge Elimination System
NSPS	New Source Performance Standards
OSHA	Occupational Safety and Health Act
PAH	polycyclic aromatic hydrocarbon
PCB	polychlorinated biphenyl
POTW	publicly owned treatment works
ppmv	part(s) per million by volume
PSD	prevention of significant deterioration
PVC	polyvinyl chloride
RCRA	Resource Conservation and Recovery Act
RF	radiofrequency
ROD	Record of Decision
RPM	revolutions per minute
SARA	Superfund Amendments and Reauthorization Act of 1986 (Public Law 99-499, stat., 1613 et seq.)
SCAQMD	South Coast Air Quality Management District
scfm	standard cubic feet per minute
SITE	Superfund Innovative Technology Evaluation (Program)
SO _x	sulfur oxides
SVE	soil vapor extraction
TBC	to be considered (technology selection constraint)
TPH	total petroleum hydrocarbons
TSCA	Toxic Substances Control Act
USC	<i>United States Code</i>
U.S. EPA	U.S. Environmental Protection Agency
UST	underground storage tanks
UVB	vacuum vaporizer well (from the German <i>Unterdruck-Verdampfer-Brunnen</i>)
VISITT	Vendor Information System for Innovative Treatment Technologies
VOC	volatile organic compound

EXECUTIVE SUMMARY

This report describes an engineering evaluation and cost analysis (EE/CA) comparing vacuum-enhanced free-product recovery (bioslurping) with traditional free-product recovery techniques to remove light, nonaqueous-phase liquid (LNAPL) from subsurface soils and aquifers. The purpose of this EE/CA is to provide a practical guide that:

- describes, compares, and evaluates LNAPL recovery technologies
- documents a consistent feasibility study approach
- provides straightforward engineering and economic criteria for technology selection and design
- lowers the risk of early technology selection and streamlines the feasibility and conceptual design process.

The technology evaluation described in this report is based on field testing at a variety of sites performed under the Bioslurper Initiative, which is funded by the U.S. Air Force Center for Environmental Excellence (AFCEE) Technology Transfer Division. The AFCEE Bioslurper Initiative is a multisite program designed to evaluate the efficacy of the bioslurping technology for (1) recovery of LNAPL from groundwater and the capillary fringe and (2) enhancing natural in situ degradation of petroleum contaminants in the vadose zone by bioventing. The overall testing approach is described in *Test Plan and Technical Protocol for Bioslurping* (AFCEE, 1995a).

The *Test Plan and Technical Protocol for Bioslurping* describes the field testing procedures required to provide sufficient data to predict the applicability of traditional and bioslurper technologies. The EE/CA describes the application of engineering and economic criteria to select the technology approach that most cost-effectively meets remedial objectives. The test plan and EE/CA document a process for cost-effectively collecting the necessary data and then using the data to conduct a consistent and fair technology evaluation and selection.

This report evaluates the feasibility of bioslurping to remediate LNAPL contamination in the saturated and unsaturated zones. Field testing done as part of the Bioslurper Initiative resulted in the collection of data to support a determination of the predictability of LNAPL recovery and to evaluate the applicability, cost, and performance of bioslurping technology for removal of free product and remediation of contaminated areas. The on-site testing is designed to allow direct comparison of the LNAPL recovery achieved by bioslurping with the more conventional approaches of skimming and drawdown pumping. Results of the field tests were used to perform a two-stage screening and technology evaluation. The first-stage screening was a qualitative evaluation of the performance of bioslurping compared to a variety of LNAPL recovery and remediation technologies. The second-stage screening was a more detailed evaluation of the effectiveness, implementability, and cost of bioslurping compared to skimming and drawdown pumping.

Bioslurping is an innovative technology that has the potential to improve free-product recovery while also promoting biological destruction of organic contaminants in situ. Bioslurping achieves both LNAPL source removal and contaminated soil remediation simultaneously. Bioslurping technology works by applying a vacuum in an extraction well to recover LNAPL and induce airflow through the unsaturated

zone. A tube is positioned in a well so that the tip of the tube is near the water-table level in the formation. Vacuum is applied at the top of the tube to make air flow into the tube, thus extracting LNAPL and water and carrying the fluids up the tube. The process is like sucking on a straw in a nearly empty glass. The groundwater/LNAPL level in the well is drawn down slightly to the level of the bioslurping suction tube. The depth of the tube can be adjusted manually, if needed. The top of the well is sealed so that a vacuum is established in the well. The negative pressure established in the well depends on the air withdrawal rate and the permeability of the surrounding formation. The reference to biological processes in the term bioslurping results from the enhanced aerobic biological degradation of the hydrocarbon due to movement of air through the unsaturated zone caused by the vacuum extraction. Thus, bioslurping causes a bioventing action in the unsaturated zone. Slurping is used in the term to describe the air entrainment and aerodynamic dragging action that lifts fluids up the slurping tube.

In a prescreening step, 12 source removal and soil remediation technologies were described and compared to bioslurping. The comparison was based on the ability of each technology to provide cleanup to protect human health and the environment (effectiveness) and on the ability to install and operate the technology at full scale (implementability). The prescreening led to focusing on a more detailed evaluation of bioslurping in comparison to skimming and drawdown pumping.

The detailed screening step compared the effectiveness, implementability, and cost of skimming, single-pump drawdown pumping, dual-pump drawdown pumping, and bioslurping. When the in situ conditions are favorable, all of the technologies reviewed in the detailed screening can be effective for recovery of LNAPL floating on the water table. The results described in this evaluation indicate that bioslurping recovers LNAPL at a higher rate and more completely removes LNAPL from the in situ formation than does either pumping or skimming.

Drawdown pumping and skimming can be effective for removal actions to recover spilled separate-phase liquids, for interim actions to control contaminants while more complete remedies are studied, or as a first step during in situ remediation to remove LNAPL. Bioslurping can be as effective in these roles as skimming or drawdown pumping but may also be used for soil remediation. Based on data collected during many field tests, bioslurping gives a higher LNAPL recovery rate than does skimming, and a similar or higher LNAPL recovery rate than does drawdown pumping. Bioslurping also provides the possibility of more complete remediation and greater flexibility by allowing the ability to shift to bioventing operation with no additional capital cost. Bioslurping is most appropriately aimed at enhancing free-product recovery. When free-product recovery rates drop to low asymptotic levels, continued site cleanup usually is best accomplished with bioventing or natural attenuation approaches.

Bioslurping induces airflow in the unsaturated zone, which helps promote biological degradation of contaminants at sites where biological activity is limited by oxygen supply. Neither skimming nor pumping is effective for remediation of unsaturated soil. When the LNAPL recovery rate drops to uneconomical rates, a bioslurping system can be quickly converted to operate in a bioventing or soil vapor extraction mode. The ability to continue remediation of the unsaturated zone without purchase of additional capital equipment gives a bioslurping system operational flexibility not available with skimming and pumping systems. These conventional LNAPL recovery technologies must be removed and replaced with new equipment if continued unsaturated zone remediation is required. The benefits of remediation in the unsaturated zone could be achieved by following the pumping or skimming process with a treatment such as soil vapor extraction or bioventing. However, this additional treatment would increase both the cost and the time required for the remediation.

There is no significant barrier to implementation of any of the candidate technologies. All of the technologies use simple equipment and monitoring methods that are readily available from a range of vendors.

Skimming and pumping require installation of LNAPL collection devices in each well. The selective scavenger of the skimming system (mesh, wick, or belt) must be installed at the groundwater level in each well. Drawdown pumping (also typically) is done by installing one or two pumps in each well. In theory, drawdown pumping can be performed with one or two pumps on the surface serving several wells, if the groundwater level (including the required drawdown) is less than about 20 feet below the surface. In practice, obtaining the required flow from each well is difficult when the system uses centralized pumping from the surface.

The bioslurping system is more amenable to using a centralized pump serving several wells. The entertainment action and drag fluid lift of the bioslurper are not controlled by the maximum practical suction lift. The fluid level in the well is controlled by the position of the slurping tube. When the fluid flow rate into the well is low, the tube draws in air. The slurping action lifts fluid only when water or LNAPL flows into the well so the bioslurper is self-adjusting and does not depend on a level detector controlling the pumps to regulate flow. The bioslurper system has less equipment in each well (i.e., one slurper tube compared to a skimmer or pumps). Simpler in-well equipment makes the bioslurper easier to install and more stable to operate compared to skimming or pumping systems.

The capital costs plus operating costs for 6 months of operation for each remedial alternative are shown in Table ES-1. These cost estimates identify that, even with off-gas treatment, the costs for bioslurping are similar to or lower than the costs for other technologies. Given the similar or lower costs and the potential for better performance, bioslurping is more cost-effective than the conventional LNAPL recovery technologies.

The evaluation of cost assumes that all of the remedial alternatives operate for 6 months. The LNAPL recovery rates measured in the study indicate that bioslurping recovers a fixed amount of LNAPL faster than skimming or drawdown pumping. However, bioslurping may recover more

Table ES-1. Total Costs for 6 Months of Operation with Each Remedial Alternatives^(a)

Remedial Technology	Base Cost (\$)	Cost with Vapor ReInjection (\$)	Cost with Off-Gas Treatment (\$)
Skimming and bioventing ^(b)	\$189,248	Not Applicable	Not Applicable
Single-pump drawdown and bioventing ^(b)	\$210,980	Not Applicable	Not Applicable
Dual-pump drawdown and bioventing ^(b)	\$252,802	Not Applicable	Not Applicable
Bioslurping	\$166,599	\$194,939	\$210,399

(a) Cost estimation is based on a system with 9 wells. More detailed discussion of the costing basis is provided in Section 5.0

(b) Cost for bioventing based on design installation, startup, and utilities for a 5,000-ft³ site form Section 7.0 of Leeson et al. (1995)

LNAPL while achieving the faster recovery rate, so the decrease in operating time, if any, is difficult to quantify. The fixed operating period is used in the cost estimates to give a consistent basis for comparison and understates the cost advantage of bioslurping. As an indication of the relative magnitude of the effect of the high LNAPL recovery rate with bioslurping, the cost per unit of LNAPL recovered is shown in Table ES-2.

Table ES-2. Comparison of Unit Cost for LNAPL Recovery

Remedial Technology	LNAPL Recovered in 6-Month Operation (gal)	Unit Cost for Recovery (\$/gal)
Skimming	558	339
Single-pump drawdown	810	260
Dual-pump drawdown	810	312
Bioslurping (with off-gas treatment)	3780	56

Bioslurping may improve free-product recovery efficiency without requiring the extraction of large quantities of groundwater. The bioslurper system pulls a vacuum of up to 15 inches of mercury in the recovery well to create airflow and a pressure gradient to force movement of LNAPL into the well. The system is operated to cause very little drawdown of the water table level, thus reducing the problem of free-product entrapment in soils exposed to LNAPL as when a cone of depression forms around a conventional drawdown well.

Where floating product forms a lens on the water table, indicating that the soils are saturated with LNAPL, conventional free-product recovery by skimming or pumping generally is effective. The conventional approaches are particularly effective when the saturated zone is in permeable soils such as sands and gravels. Skimming will recover LNAPL with little or no water, whereas single-pump drawdown systems recover a mixture of LNAPL and water. A dual-pump system can recover LNAPL and water as separate streams, but using the dual-pump approach increases the system cost and still brings groundwater to the surface which must then be managed. Skimming recovers LNAPL at a lower rate than does either pumping method.

Application of a vacuum to enhance LNAPL recovery (bioslurping) can increase both the speed and the completeness of LNAPL removal. Application of negative pressure in an extraction well increases the driving force for advection into the well without requiring the water level to be lowered. The increased driving force increases the flowrate of fluids into the well. After the majority of floating LNAPL is recovered, significant LNAPL remains trapped in the soil pores. Bioslurping can mobilize a portion of the LNAPL by applying a negative pressure in the soil porosity around the bioslurping well while water and LNAPL are being extracted. If the vacuum exerted on the formation is sufficient, capillary forces holding LNAPL in the pores are overcome and the fluid is pulled from the pores and moved to the extraction well.

Bioslurping stimulates biological degradation of organic contaminants in the unsaturated zone during operation and is easily converted to perform bioventing for continued remediation after all the free

LNAPL has been recovered. The air withdrawal during bioslurping aerates the soil, which will increase the biodegradation rates at sites where biological activity is limited by oxygen availability in the soil. If organic-contaminants remain in the unsaturated zone after the LNAPL has been removed, the slurping tube can be removed or raised above the water table level to allow continued operation as a bioventing system. If bioventing is required to finish cleanup at a site where skimming or pumping has been used for LNAPL recovery, additional equipment must be purchased and installed.

ENGINEERING EVALUATION AND COST ANALYSIS FOR BIOSLURPER INITIATIVE (A005)

25 March 1997

1.0 INTRODUCTION

This report provides an overview of the field performance of bioslurping, an innovative technology for vacuum-assisted recovery of light, nonaqueous-phase liquid (LNAPL). The report is based on field testing performed under the Bioslurper Initiative, which is funded by the U.S. Air Force Center for Environmental Excellence (AFCEE) Technology Transfer Division. The AFCEE Bioslurper Initiative is a multisite program designed to evaluate the efficacy of the bioslurping technology for (1) recovery of LNAPL from groundwater and the capillary fringe and (2) enhancing natural in situ degradation of petroleum contaminants in the vadose (unsaturated) zone by bioventing. Bioslurping is compared to skimming and drawdown pumping based on data collected from field testing at more than 35 sites supplemented by engineering estimates. The overall testing approach is described in *Test Plan and Technical Protocol for Bioslurping* (AFCEE, 1995a). The technologies are compared based on effectiveness, implementability, and cost.

1.1 Objectives

This report evaluates the technical feasibility of bioslurping to remediate LNAPL contamination in the saturated and unsaturated zones and compares the cost effectiveness with respect to other source removal and soil remediation technologies. The purpose of the report is to describe and clarify the operating principles, and to compare and contrast bioslurping to similar technologies applied in a variety of site settings. The purpose of this EE/CA is to provide a practical guide that:

- describes, compares, and evaluates LNAPL recovery technologies
- documents a consistent feasibility study approach
- provides straightforward engineering and economic criteria for technology selection and design
- lowers the risk of early technology selection and streamlines the feasibility and conceptual design process.

Excavation and treatment aboveground may be selected as the remedial action for contaminated soils, particularly if rapid remediation or contaminant removal to background concentrations is required. However, aboveground technologies are not discussed because they apply fundamentally different mechanisms and, therefore, provide no basis for clarifying or evaluating the operating principles or performance of bioslurping. Capping, containment, and immobilization technologies are not discussed because they do not reduce the amount of contaminant and do not use similar methods to in situ treatment technologies.

The evaluation is based on data collected from field tests at U.S. Air Force and other U.S. Department of Defense sites. The data collected as part of the Bioslurper Initiative are supplemented with data from literature sources. Tests were conducted throughout the United States and its possessions to obtain performance data in a variety of geologic settings. The contaminants of concern are jet fuel, gasoline, and similar petroleum hydrocarbons with a specific gravity less than 1 at 25°C and with low to medium viscosity.

The evaluation is based also on the performance of bioslurping compared to more conventional LNAPL recovery technologies. Consistent field testing data were collected for skimming and drawdown pumping configurations at the same time the bioslurping data were collected to give the basis for the comparison. The evaluation is based on the effectiveness, implementability, and cost of the technologies.

The main focus of the test program and evaluation is recovery of LNAPL. However, bioslurping also enhances biodegradation in the unsaturated zone, whereas skimming and drawdown pumping do not. Bioslurping is the only low-cost, easily implemented technology identified in this study having the ability to simultaneously recover LNAPL and efficiently treat organic contaminants in the unsaturated zone. This particular advantage of bioslurping is also discussed and considered in the evaluation.

1.2 Organization of Report

This report is organized in the format of an engineering evaluation and cost analysis (EE/CA) performed for a removal action under the Comprehensive Environmental Response, Compensation, and Liability Act of 1980 (CERCLA) [as amended by the Superfund Amendments and Reauthorization Act of 1986 (SARA)]. The format, organization, and evaluation process used in this EE/CA report are considered to be compatible with those for non-CERCLA, state regulatory programs. The EE/CA format is used to provide a standardized and familiar organization for performance and cost evaluation. Unlike a typical EE/CA, this report gives a general evaluation of bioslurping compared to conventional LNAPL recovery technologies. The report has been developed to aid and direct streamlined preparation of site-specific plans.

Section 2.0 summarizes data collected during the field tests performed for the Bioslurper Initiative. These data provide the basis for the design and cost estimates done to support the technology evaluation. Technology performance requirements and constraints are developed from the applicable or relevant and appropriate requirements (ARARs) outlined in Section 3.0. These requirements and constraints are the basis for the screening of the technologies in Sections 4.0 and 5.0. Section 4.0 describes the identification and screening of a wide range of in situ technologies for recovery of LNAPL, remediation of LNAPL in groundwater, and/or remediation of LNAPL in the unsaturated zone. The screening selects a smaller subset of technologies by identifying the candidates most likely to provide effective, implementable, and cost-effective remediation. This smaller subset of technologies is described in more detail in Section 5.0 and compared and evaluated in Section 6.0. The results of the evaluation process are summarized and discussed in Section 7.0. References cited in the document are provided in Section 8.0.

2.0 SUMMARY OF TESTING PROGRAM RESULTS

Figure 2-1 indicates the general conceptual model of contaminant distribution for sites where bioslurping tests were performed. At the test sites, LNAPL has been released to the environment by spills, leaks, or other mechanisms. The LNAPL has migrated downward to the water table and formed a separate layer on the capillary fringe or water table. Any seasonal variations of the water-table layer can spread contaminants in a vertical band at the water-table level. Contaminant liquids and vapor also have reached soils in the unsaturated zone.

This section tabulates key results collected during the field testing of the bioslurping technology at seven sites (eight locations). Methods used to collect the data are described in the *Test Plan and Technical Protocol Bioslurping* (AFCEE, 1995a). The testing consisted of initial site characterization activities to evaluate site parameters that may affect LNAPL recovery efficiency. The initial site characterization included measurements of the water-table level and LNAPL layer thickness, baildown testing, slug testing, soil sampling and analysis, radius of influence measurement, and in situ respiration testing. Following the site characterization activities, a short-term bioslurper pilot test was conducted. The test involved installing a bioslurper system in a single well and operating it to simulate the performance of skimming, bioslurping, or drawdown pumping systems. Parameters measured included the volume of LNAPL and groundwater recovered as a function of time, the off-gas flowrate during bioslurping, and the contaminant content of extracted groundwater and bioslurper system off-gas. In early tests, the testing schedule involved skimming, slurping, and drawdown pumping in sequence. The test program was

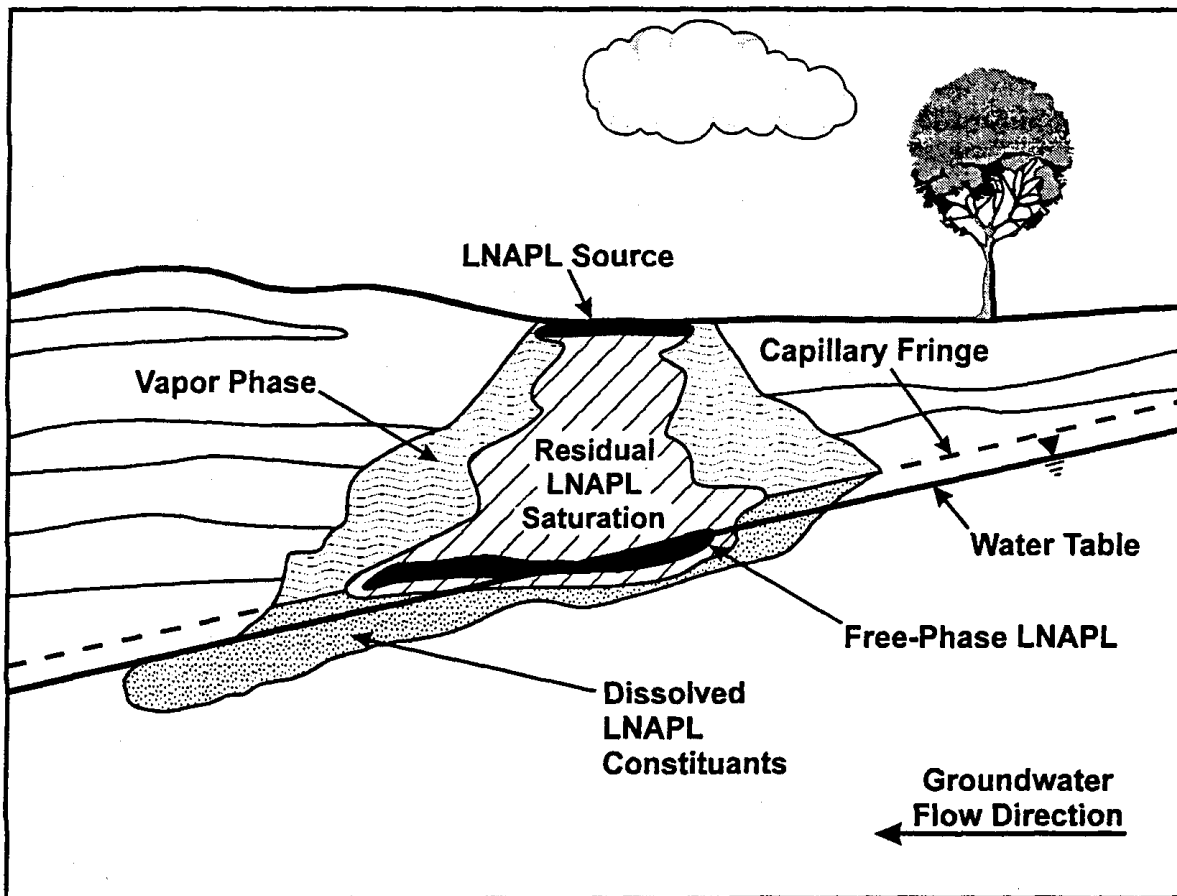

Figure 2-1. Contaminant Distribution at a Typical LNAPL Site.

later modified to perform skimming, slurping, a return to skimming, and drawdown pumping in sequence. The test setup allows switching between operating modes in less than 15 minutes. The initial and modified test schedules are shown in Table 2-1.

Table 2-1. Bioslurper Initiative Testing Schedules

Pilot Test Activity	Initial Schedule (days from start)	Revised Schedule (days from start)
Mobilization	day 1 and 2	day 1 and 2
Site Characterization	day 2 to 3	day 9 to 12
Product/Groundwater Interface Monitoring		
Baildown Tests		
Slug Test ^(a)		
Soil Gas Survey		
Monitoring Point Installation		
Soil Sampling		
System Installation and Startup	day 2 to 3	day 2 and 3
Skimmer Test	day 4	day 3 and 4
Bioslurper Vacuum Extraction Test	day 5 to 8	day 5 to 9
Soil Gas Permeability Test	day 5	day 5
Skimmer Test Repetition	Not performed	day 10
In Situ Respiration Test	day 9 to 12	day 11 to 14
Drawdown Pump Test	day 9	day 11 and 12
Demobilization	day 12 to 14	day 13 and 14

(a) Slug test was not performed at all sites after the schedule revision.

Site and technology performance characteristics are presented for skimming, bioslurping, and drawdown tests. The data provide the basis for the evaluation of the technologies. The general features of the test sites are summarized in Table 2-2. Table 2-3 summarizes the results of testing for skimming, bioslurping, and drawdown pumping. The sustained rates of LNAPL recovery and groundwater removal in Table 2-3 are estimates of the rates that could be maintained for extended periods of operation in the particular configurations. The sustained rate estimates discount the effect of the rapid recovery that usually occurs at the start of LNAPL recovery by using the rate of recovery after a stable rate is reached in each operating mode. The sustained rates of LNAPL and groundwater recovery typically are determined based on recovery in the last two-thirds to one-half of each testing period.

Table 2-2. Summary of Characteristics at Bioslurper Initiative Sites

Site	Fuel Type	Initial LNAPL Thickness (ft)	Depth to Groundwater (ft)	Pressure Radius of Influence (ft)	Slug Test Hydraulic Conductivity (ft/day)
Andrews AFB, MD	No. 2 Fuel Oil	2.02	15.11	250	1.70
Bolling AFB, DC (Site 1)	No. 2 Fuel Oil	3.52	22.94	45	1.35
Bolling AFB, DC (Site 2)	Gasoline	1.12	19.69	47	23.78
Dover AFB, DE	JP-4	3.63	13.95	37	No Data
Edwards AFB, CA	Jet Fuel (AvGas)	3.02	21.93	43	No Data
Havre AFS, MT (MW-7)	No. 2 Fuel Oil	0.28	15.04	12	No Data
Havre AFS, MT (MW-F)	No. 2 Fuel Oil	0.22	13.98	18	No Data
Hickam AFB, HI	Aviation Gasoline	3.89	18.33	No Data	12.67
Hill AFB, UT	Fuel Oil	0.56	28.95	80	No Data
Johnston Atoll DNA	JP-5	0.84	7.81	15	No Data
Kaneohe MCB, HI	JP-5	0.23	16.08	23	No Data
March AFB, CA					
MW-03	JP-4	0.26	36.97	No Data	No Data
MW-04	JP-4	0.43	35.33	No Data	No Data
McGuire AFB, NJ	JP-4	2.30	15.59	No Data	No Data
Robins AFB, GA (UST 70/72)	JP-4	1.82	8.49	57	No Data
Robins AFB, GA	JP-4	0.48	7.25	76	No Data
Travis AFB, CA	JP-4	0.4	8.7	55.3	0.23
Tyndall AFB, FL					
MW-5	JP-4	1.47	8.67	60	No Data
EX-1, EX-2	JP-4	No Data	No Data	No Data	No Data
Wright-Patterson AFB, OH	JP-4	0.12	20.69	49	6.53

Table 2-3. Summary of Performance Results at Bioslurper Initiative Sites

Site	Skimming	Bioslurping				Drawdown		Water TPH Conc. (mg/L)
	Sustained LNAPL Recovery Rate (gal/day)	Sustained LNAPL Recovery Rate (gal/day)	Sustained H ₂ O Removal Rate (gal/day)	Off-Gas Flowrate (scfm)	Off-Gas TPH Conc. (ppmv)	Sustained LNAPL Recovery Rate (gal/day)	Sustained H ₂ O Removal Rate (gal/day)	
Andrews AFB, MD	6.62 0.71*	64.2	2,963	7.9	2,000	No Data ^(a)	1,000 ^(a)	272 ⁽¹⁾
Bolling AFB, DC (Site 1)	15.25	59.85	2,751	4	33 ⁽⁵⁾	31.2	2,664	12.25 ⁽¹⁾
Bolling AFB, DC (Site 2)	0.0	0.48	1,286	21	70,000 0.71 ⁽⁵⁾	0.126	998	49 ⁽¹⁾
Dover AFB, DE	27.9 9.4*	43.2	2,844	78	21,000 110 ⁽⁶⁾	No Data	No Data	960 ⁽¹⁾ 175 ⁽²⁾ <1.0 ⁽⁴⁾
Edwards AFB, CA	13	55.8 73*	536 570*	5	26,000 1,030 ⁽⁶⁾	No Data	No Data	11 ⁽¹⁾
Havre AFS, MT (MW-7)	0.19 0.012	0.073	64	23	66	0.01	15	22(1)
Havre AFS, MT (MW-F)	No Data	0.62	29	20	Not Sampled	No Data	No Data	Not Sampled
Hickam AFB, HI	16.5	Insufficient Data ^(b)	Insufficient Data ^(b)	3.2	100,000	Insufficient Data ^(b)	Insufficient Data ^(b)	132 ⁽¹⁾
Hill AFB, UT	0.80 0.60*	1.5	1,433	32	4,900	0.5	2,400	180 ⁽¹⁾ 7.4 ⁽²⁾
Johnson Atoll DNA	29.8 3.6*	32	1,375	10	975	9.0	1,470	<1.0 ⁽¹⁾
Kaneohe MCB, HI	0.06 0.0*	2.39	40.2	20	2,000	0.0	21.4	8.05
March AFB, CA MW-03	No Data	1.8 ^{LV} 7.13 ^{HV}	1,751 ^{LV} 3,316 ^{HV}	25	48,000 0.28 ⁽⁶⁾	No Data	No Data	No Data ^(c)
MW-04	0.0	0.0	4,705	75	5,900	0.0	3.816	No Data

Site	Skimming	Bioslurping				Drawdown		Water TPH Conc. (mg/L)
	Sustained LNAPL Recovery Rate (gal/day)	Sustained LNAPL Recovery Rate (gal/day)	Sustained H ₂ O Removal Rate (gal/day)	Off-Gas Flowrate (scfm)	Off-Gas TPH Conc. (ppmv)	Sustained LNAPL Recovery Rate (gal/day)	Sustained H ₂ O Removal Rate (gal/day)	
McGuire AFB, NJ	2.3 6.6*	30.0	4,600	120/60 ^(d)	67,000 1.3 ⁽⁶⁾	1.2	730	47 ⁽¹⁾ 38 ⁽²⁾
Robins AFB, GA	6.3 5.0*	40	1,275	5	37,000	12	2,100	22 ⁽¹⁾ 29 ⁽²⁾ 20 ⁽³⁾ <0.50 ⁽⁴⁾
Robins AFB, GA	1.1	2.3	1,385	5.5	680	0.36	1,800	46 ⁽¹⁾ 36 ⁽²⁾ 22 ⁽³⁾ <0.50 ⁽⁴⁾
Travis AFB, CA	0	3.41	375	20	10,800	3.59	480	16.75 ⁽¹⁾
Tyndall AFB, FL MW-5	0.24	0.23	1,414	6	28,000	0.68	2,207	11.2 ⁽²⁾
EX-1, EX-2	No Data	36.1	1,593	6	No Data	No Data	No Data	100 ⁽²⁾
Wright-Patterson AFB, OH	1.48	4.85	1,807	3.0	595	0.0	2,610	<0.50 ⁽¹⁾

(1) Water collected from oil/water separator.

(2) Water collected from settling tank discharge.

(3) Water collected after clay treatment.

(4) Water collected after carbon treatment.

(5) Off-gas collected after carbon treatment.

(6) Off-gas collected from ICE.

(a) Drawdown test not completed due to high water-removal rate.

(b) Duration of test too short to determine sustained-recovery site.

(c) Sampled but not analyzed due to lab error.

(d) 120 scfm with ICE and 60 scfm without ICE

^{LV} Low-vacuum bioslurper pump test.

^{HV} High-vacuum bioslurper pump test.

* Indicates repeated pump test.

3.0 SITE CLEANUP STANDARDS

This section describes a review of laws and regulations to identify applicable or relevant and appropriate requirements (ARARs) and the remedial action objectives and technology selection constraints derived from the ARARs. Although most of the following terminology is derived from federal statutes and regulations, state programs and regulations must be directly integrated in the determination of constraints on technology selection. The Air Force Installation Restoration Program (IRP) follows a CERCLA-like approach at sites regulated by state and/or federal regulators; therefore, the regulatory considerations described in this section are generally compatible with technology selection for a wide range of IRP sites.

3.1 Applicable or Relevant and Appropriate Requirements

Many laws, regulations, and other sources of guidance or standards constrain the application of remediation methods. This section discusses the environmental legal requirements that may pertain to LNAPL remediation technologies. Federal requirements are reviewed for possible sources of ARARs.

Section 121 of CERCLA requires that site cleanups must comply with the most stringent federal, state, and local environmental requirements that are ARARs. In many cases state or local requirements (for example, water or air quality standards; requirements for use of recycled materials; or health, safety, or fire protection codes) are more restrictive than federal standards. State and local laws are not reviewed in detail due to the generic nature of the technology evaluation and the lack of a single defined site location. State and local laws must be considered for a site-specific evaluation.

Three types of ARARs will be discussed along with possible waivers from ARARs. U.S. Environmental Protection Agency (U.S. EPA) guidance provides for three (3) categories of ARARs: (1) ambient or chemical-specific requirements; (2) location-specific requirements; and (3) performance, design, or other action-specific requirements. The first category often is applicable to the remediation action objective; the latter two give rise to site specific influences on remedial technology selection.

Remedial alternatives are evaluated on the basis of air and water quality, waste management, and other standards that could serve as ARARs. Summaries of potentially applicable chemical-, location-, and action-specific ARARs are provided in Tables 3-1 through 3-3, respectively. Some additional background on major federal laws and regulations also is provided.

Section 121(d)(2)(A) of CERCLA, as amended by SARA, requires that federal facility remedial actions comply with requirements or standards developed to implement federal and state environmental laws. In general, remedial actions must comply with ARARs for the contaminants or conditions that exist at a site, except in cases in which an ARAR can be waived. According to U.S. EPA's interim guidance on ARARs (52 FR 32496, Aug. 27, 1988) and the revised National Contingency Plan (NCP)(55 FR 8666, March 8, 1990), a requirement may be either "applicable" or "relevant and appropriate" to a remedial action, but not both. Applicable requirements specifically address a hazardous substance, remedial action, location, or other circumstance at a CERCLA site. "Applicability" means that the remedial action or circumstances at the site must satisfy all of the jurisdictional prerequisites of a requirement. Although relevant and appropriate requirements may not meet the conditions for applicability, they address problems or situations sufficiently similar to those at a CERCLA site that their use is well suited to a particular set of circumstances.

The degree to which a requirement is relevant and appropriate can be assessed by comparing the hazardous substance involved, the physical circumstances, or the remedial action characteristics with those addressed in the requirement. The objectives and origin of the requirement also pertain. An ARAR may be waived under certain conditions, provided that human health and the environment are protected.

3.1.1. Chemical-Specific ARARs

Chemical-specific ARARs (Table 3-1) are numeric values, such as concentration limits or ranges, for specific substances in various environmental media. These limits are either health-based or risk-based standards modified to consider the economic and technical feasibility of implementation. Chemical-specific ARARs include soil cleanup standards, surface and groundwater cleanup standards, and RCRA cleanup standards. Examples of chemical-specific ARARs include maximum contaminant levels (MCLs) for public drinking water and National Ambient Air Quality Standards (NAAQS) for air quality.

Table 3-1. Renew of Potential Chemical-Specific ARARs

Law/Regulation	Description
Resource Conservation and Recovery Act (RCRA); 40 CFR Parts 260-280	This act establishes maximum contaminant levels (MCLs) for groundwater and treatment standards [based on best demonstrated available technologies (BDATs)] for hazardous wastes covered by the land disposal restrictions (LDRs).
Federal Clean Air Act; 40 CFR Parts 50-80	This act sets limits on levels of air pollutants.
Federal Clean Water Act; 40 CFR Parts 100-140, 400-470	This act sets limits on levels of water pollutants.
Safe Drinking Water Act; 40 CFR Parts 141, 143, 260-280	This act and these regulations established MCLs and maximum contaminant level goals (MCLGs) for drinking water supplies.
Underground Injection Control Regulations; 40 CFR Parts 144-147	
U.S. Water Quality Criteria	These are standards for ambient surface water quality. These are not rules and have no direct regulatory authority but may be included as to be considered (TBC) criteria.
Occupational Safety and Health Act (OSHA); 29 USC 651-678; 29 CFR Parts 1904, 1910, 1926	This act provides occupational safety and health requirements applicable to workers engaged in onsite field activities.

Currently, there are no promulgated federal chemical-specific concentration limits for LNAPL in soil. However, ARARs in other media (air, groundwater, and surface water) may play a significant role in decisions involving the remediation of LNAPL in soils. LNAPL generally is considered mobile and may migrate through soils, dissolve in water, become suspended as emulsions in water, or volatilize in air. Constituents of petroleum hydrocarbons, for example benzene, toluene, ethylbenzene, and xylenes (BTEX), can represent a significant source of risk through groundwater pathways. Therefore,

the need for remediation and the establishment of soil cleanup goals for LNAPL should take into consideration ARARs in other media using appropriate fate and transport models.

Many states have soil cleanup criteria or guidance values for total petroleum hydrocarbons or specific compounds. These criteria or this guidance should be considered during analysis of ARARs. The basis for determining soil cleanup targets under RCRA Underground Storage Tank regulations is out-lined in Section 3.2.2.

3.1.2 Location-Specific ARARs

Location-specific ARARs establish additional restrictions on contaminant levels or activities in the environment and are the result of the unique nature of the site or its immediate environment. Examples of locations that frequently result in constraints on remedial alternatives include protected floodplains, wetlands, endangered species habitats, or archaeologically and historically significant sites. In Table 3-2, location-specific ARARs are organized into the following categories: seismicity; wilderness areas, wildlife refuges, and scenic rivers; wetlands and floodplains; critical habitats; and artifacts and historical and archeological sites.

Table 3-2. Renew of Potential Location-Specific ARARs

Location-Specific Factor	Citation	Requirement
Seismicity	Location Standards, Permitted Hazardous Waste Facilities; 40 CFR 264.18	Facilities must not be located within 200 feet of a fault that has been displaced in Holocene time.
Wilderness Areas, Wildlife	Fish and Wildlife Coordination Act; 16 USC 661 et seq.	This act requires that actions affecting fish and wildlife must include provisions to protect the affected fish and wildlife resources.
	Wild and Scenic Rivers Act; 16-USC 1271 et seq.	This act protects designated rivers or river sections in the National Wild and Scenic Rivers System.
	Wilderness Act; 16 USC 1131 et seq.	This act protects and restricts activities in areas designated as part of the National Wilderness Preservation System.
Wetlands, Flood Plains	Executive Order 11990; Protection of Wetlands; 40 CFR Part 6, Appendix A; 40 CFR 6.302(a)	Federal agencies must take action to avoid adverse impacts, to minimize potential harm, and to preserve and enhance wetlands to the extent possible.
	Executive Order 11988; Protection of Floodplains	Adverse effects associated with the development of a floodplain must be evaluated.
	40 CFR Part 6, Appendix A	Federal agencies are required to incorporate floodplain management goals and wetlands protection considerations in their planning, regulatory, and decision-making processes.

Table 3-2. Review of Potential Location-Specific ARARs (Continued)

Location-Specific Factor	Citation	Requirement
Wetlands, Floodplains (continued)	40 CFR Part 6, Appendix A	Federal agencies should avoid new construction in wetlands areas.
	Clean Water Act §404; 40 CFR 230.10; 33 CFR Parts 320-330	This act prohibits discharge of dredge or fill material into wetlands without a permit.
	Clean Water Act §404(b)(1)	This act provides for the enhancement, restoration, or creation of alternative wetlands.
Critical habitat upon which an endangered or threatened species depends	Location Standards, Permitted Hazardous Waste Facilities; 40 CFR 264.18	This regulation requires facility design to prevent washout of hazardous waste.
	Endangered Species Act of 1973 (ESA); 16 USC 1531 et seq.; 50 CFR Parts 200 and 402	Individuals must take action to conserve endangered or threatened species and must not destroy or adversely modify critical habitat.
	Fish and Wildlife Coordination Act; 16 USC 661 et seq.	Individuals must consult with Department of Interior, Fish and Wildlife Service, and state personnel required to ascertain that proposed actions will not affect any listed species.
Fish & Wildlife Conservation Act; 16 USC 2901		
Within areas where action may cause irreparable harm, loss, or destruction of significant artifacts	Archaeological and Historic Preservation Act; 16 USC 469 to 469c-1	Individuals must take action to recover and preserve artifacts.
Property included in or eligible for the National Registry of Historic Places	National Historic Preservation Act (NHPA); 16 USC 470 et seq.; 36 CFR 800.1	Individuals must take action to preserve historic properties and plan actions to minimize harm to National Historic Landmarks.
	National Historic Landmarks Program; 36 CFR Part 65	
	National Register of Historic Places; 36 CFR Part 60	
	Executive Order 11593; 36 CFR 800.4	
Archaeological sites or resources on public land	Archaeological Resources Protection Act of 1979; 16 USC 470aa-11; 43 CFR Part 7	Individuals must take steps to protect resources and to preserve data.

It is unlikely that location-specific ARARs would strongly favor or constrain any of the candidate technologies. Recovery of floating LNAPL and remediation of LNAPL contamination typically will be applied in industrial or fuel-handling areas. Given the previous activities in these areas, it is unlikely that there will be critical habitat, sensitive environments, or cultural resources nearby. The evaluation of bioslurping and similar technologies includes only in situ technologies that cause minimum disturbance to the environment. Components of the treatment system located on the surface are designed as transportable modules that require limited infrastructure and site modification for movement to, set up at, and operation on a site.

Regardless of the technology selected, careful study, planning, and design are needed to ensure the site remediation minimizes adverse effects on the environment. For example, if the site is near critical habitat for endangered or threatened species, or if the property is eligible for protection of historical or cultural aspects, location and operation of remediation equipment should be designed to minimize adverse effects. These ARARs will be specific to the site and will be identified and considered when a particular site is identified.

3.1.3 Action-Specific ARARs

Action-specific ARARs (Table 3-3) are technology- or activity-based requirements or standards. The process to select remedial alternatives must consider the regulatory requirements associated with each proposed technology. Examples of action-specific ARARs include monitoring requirements, effluent discharge limits, hazardous waste manifesting requirements, and worker health and safety requirements. Air and water discharge streams will be required to meet permitting standards typically set by local jurisdictions. Standards required to control nontoxic environmental nuisances can also influence the performance of specific technologies. For example, high-temperature in situ treatment such as radiofrequency (RF) heating can cause nuisance odor releases, or an internal combustion engine used for off-gas treatment produces noise that could be unacceptable in some areas.

Table 3-3. Review of Potential Action-Specific ARARs

Law/Regulation	Comments
Resource Conservation and Recovery Act (RCRA) U.S. EPA Regulations for Hazardous Waste; 40 CFR Parts 260 through 270	These rules establish a comprehensive cradle-to-grave program for safe management of hazardous waste. Contaminated soils that are sufficiently similar to hazardous waste under RCRA or state regulations may be affected by these regulations as ARARs or as to be considered (TBC) guidance.
U.S. EPA Underground Storage Tank Requirements; 40 CFR Part 280	These regulations provide a regulatory program for underground storage tanks.
Toxic Substances Control Act (TSCA); 15 USC 2601 et seq.	This act provides for regulation of specific toxic substances, including polychlorinated biphenyls (PCBs).
Federal Insecticide, Fungicide, and Rodenticide Act (FIFRA); 7 USC 136 et seq.	This act provides for regulation of the production, use, and disposal of pesticides.
National Environmental Policy Act (NEPA); 42 USC 4321 et seq.	This act requires that all major federal actions be evaluated for potential impacts on the environment.
Pollution Prevention Act of 1990: 42 USC 13101 et seq.	This act encourages eliminating or reducing the production of hazardous or toxic wastes at the source and responsible recycling .

3.2 Summary of Major Federal Statutes and Regulations

This section provides general information on the identification and determination of potential ARARs for remedial actions at Superfund sites. The information presented is meant not to be an exhaustive discussion on compliance with ARARs, but a representative listing of federal sources for ARARs. The following principal statutes and regulations are included in the review of potential ARARs (Sections 3.4.1 through 3.4.6):

- Resource Conservation and Recovery Act Hazardous Waste Regulations
- Resource Conservation and Recovery Act Underground Storage Tank Regulations
- Clean Air Act
- Clean Water Act
- Safe Drinking Water Act
- U.S. Water Quality Criteria.

Each statute or regulation is discussed with regard to remedial actions at Superfund sites.

3.2.1 Resource Conservation and Recovery Act Hazardous Waste Regulations

For RCRA requirements to be applicable or relevant and appropriate to CERCLA actions, a RCRA hazardous waste or a waste sufficiently similar to a RCRA hazardous waste must be present at the site. RCRA regulates characteristic hazardous wastes (40 CFR 261.20 through 261.24, "Subpart C, Characteristics of Hazardous Waste") and listed hazardous wastes (40 CFR 261.30 through 261.33, "Subpart D, Lists of Hazardous Wastes"). The three types of listed wastes are wastes from nonspecific sources (40 CFR 261.31); wastes from specific sources (40 CFR 261.32); and discarded commercial chemical products, off-specification species, container residues, and spill residues thereof (40 CFR 261.33).

3.2.2 Resource Conservation and Recovery Act Underground Storage Tank Regulations

Federal Underground Storage Tank (UST) regulations (40 CFR Part 280) do not provide specific soil cleanup standards. The federal regulations define methods for developing cleanup standards. A brief synopsis of the relevant subparts of the federal regulations governing UST corrective action plans follows.

Corrective Action Plan (40 CFR 280.66):

- (a) Upon review of information from 40 CFR 280.61 - 280.63, the agency may require owners and operators to submit additional information or to develop a corrective action plan.
- (b) The plan must provide for adequate protection of human health, safety, and environmental protection, and should include:
 - characteristics of released substance, including toxicity and mobility
 - hydrogeologic characteristics of facility and area
 - proximity, quality, and present and future uses of nearby surface water and groundwater

- potential effects of residual contamination on surface water and groundwater
 - exposure assessment
 - any information compiled during fulfillment of these requirements.
- (c) Upon approval, implement plan; monitor, evaluate, and report results to the satisfaction of the implementing agency.
- (d) Corrective action may begin prior to approval if owners and operators:
- notify agency of intention to begin cleanup
 - comply with agency conditions
 - incorporate these measures into corrective action plan submitted to agency for approval.

Public Participation (40 CFR 280.67):

- (a) If corrective action plan is required, the implementing agency must notify affected public.
- (b) The agency must make information and decisions about the corrective action plan available to the public.
- (c) Before corrective action plan approval, the agency may hold a public meeting to consider comments if sufficient interest exists.
- (d) If the corrective action plan has not achieved target, and termination of the plan is being considered, the agency must notify the public.

Soil cleanup targets are determined on a site-specific basis based on state and local regulations and guidelines. Site-specific criteria may be influenced by the location of the site as it affects human health and the environment. Remediation guidelines are generally set based on the risk associated with the contamination of public and private drinking water supplies, or other exposure pathways (e.g., vapor exposure). Factors that are considered in the establishment of cleanup standards include location of drinking water supplies, public utilities (such as sewers) in the area that may provide a pathway for future migration, and nearby buildings in the area that may be at risk of an explosion.

Some states have established standards for cleanup of TPH in soils at UST sites. A survey of 25 states, conducted in late 1995, found that 11 of the states had limits or guidelines for TPH cleanup. The most common value was 100 mg/kg, but a few states allowed higher levels, particularly for industrial sites (Hazardous Waste Consultant, 1996).

Determining when a site remediation system can be shut down and the site considered "clean" may require a site-specific risk assessment. These elements typically are required in a risk assessment:

- Site characterization - soil types, groundwater levels and flow direction, bedrock formations.

- Hazard identification - hazardous substances at the site that could pose a threat to human health and the environment.
- Fate analysis - pathways through which these hazardous substance may migrate (i.e., groundwater, surface water, direct, air, etc.).
- Exposure assessment - risk is generally reported as a value related to the number of individuals exposed or at risk. For example, a value of 1E-6 indicates that one out of one million people exposed is at risk.
- Risk management - levels to which contamination is reduced to achieve "acceptable" risk. "Acceptable risk" typically is defined as falling between 1E-5 and 1E-7.

3.2.3 Clean Air Act of 1990 (42 USC 7401-7642)

The Clean Air Act (CAA) promulgated the following standards that may or may not be ARARs at the site due to the following reasons:

- NAAQS apply to total suspended particulate, sulfur dioxide, nitrogen dioxide, carbon monoxide, ozone, and lead concentrations in ambient air and are not applicable to individual emission sources. "Prevention of significant deterioration" (PSD) regulations may apply preconstruction guidelines and monitoring to statutory sources.
- New Source Performance Standards (NSPS) were developed for specific industrial categories to provide a ceiling for emissions from new sources.
- Title III of the CAA requires development of Maximum Achievable Control Technology (MACT) standards for 189 hazardous air pollutants (HAPs).

In addition to standards developed under the Clean Air Act, state and local authorities usually have air release permitting requirements. The air release standards set by these authorities vary widely and may range from little or no formal regulation to contaminant-specific mass discharge rates. Some authorities base their standards on the concentration at the nearest receptor, whereas others consider each site on a case-by-case basis.

3.2.4 Clean Water Act (33 USC 1251-1376)

The Clean Water Act sets standards and requirements for pollutant discharge. The National Pollutant Discharge Elimination System (NPDES) (40 CFR Parts 122 and 125) requires permits for the discharge of pollutants from any point source into the waters of the United States. General pretreatment regulations are enforceable standards promulgated under 40 CFR Part 403 for discharge to a publicly owned treatment works (POTW) and could be ARARs if surface or groundwater remediation results in discharge to a POTW.

3.2.5 Safe Drinking Water Act (40 USC 300)

The Safe Drinking Water Act promulgated both the National Primary Drinking Water Regulations (40 CFR Part 141) and National Secondary Drinking Water Regulations (40 CFR Part 143). Primary

MCLs are enforceable standards for contaminants in public drinking water supply systems. Primary MCLs are set with regard to health factors, economic feasibility, and the technical feasibility of removing a contaminant from a water supply system. Secondary MCLs are intended as guidelines to protect the public welfare. Contaminants covered by secondary MCLs are those that may adversely affect the aesthetic quality of drinking water such as taste, odor, color, and appearance and that may deter public acceptance of drinking water provided by public water systems.

Maximum contaminant limit goals (MCLGs) exist for several organic and inorganic compounds found in drinking water. MCLGs are nonenforceable guidelines that consider only health factors.

During a feasibility study or engineering evaluation, MCLs or MCLGs may be used to determine remedial actions for surface water or groundwater that is a current or potential source of drinking water. The NCP requires that MCLGs set at levels above zero (i.e., nonzero MCLGs) be attained during a CERCLA cleanup. In cases where the MCLG equals zero, the corresponding MCL is applicable [40 CFR 300.430(e)(2)(i)(B) and (C)].

Underground injection control regulations (40 CFR Parts 144-147) provide for the protection of underground sources of drinking water. These regulations may apply if the remedial design includes reinjection of water.

3.2.6 U.S. Water Quality Criteria

The water quality criteria (U.S. EPA, 1986, EPA/440/5-86/001) are concentrations of pollutants calculated for ambient surface water quality to protect human health and aquatic life. Criteria are set for both acute and chronic effects.

Generally, water quality criteria are not enforceable regulations, except when they have been adopted by a state as part of the state's water quality standards. Rather, these criteria present useful guidance on the environmental effects of pollutants. These water quality criteria may be included as TBC conditions when setting remedial action objectives.

3.3 Remedial Action Objectives

As discussed above, the primary focus of this report is to support the selection of a remedial approach aimed at the recovery of LNAPL floating on the water table and the remediation of soils in the capillary fringe and unsaturated zone. This report describes a general evaluation of LNAPL recovery technologies based on data from many test sites. Therefore, it is not possible to develop site-specific remedial action objectives, but it is useful to discuss possible cleanup requirements and the constraints that develop from those requirements.

Remedial action objectives are media-specific or site-specific goals for protecting human health and the environment. Remedial action objectives will be established for each site based on consideration of ARARs and site-specific risk assessments. If the site requires cleanup to leave contaminant concentrations at or near background levels, none of the in situ treatment technologies described and evaluated in this report are likely to be effective. At sites where fuel use or other industrial activities will continue, less restrictive remedial action objectives may be established. Less restrictive remedial action objectives are commonly established based on continued use for the same or similar activities.

This technology evaluation report is based on the remedial action objective of recovering the maximum quantity possible of LNAPL and remediation of soils in the unsaturated zone to concentrations acceptable for an industrial area. LNAPL recovery complements soil and groundwater remediation technologies and can be used in combination with a variety of soil and/or groundwater remediation options. LNAPL recovery is best accomplished by skimming, drawdown pumping, or bioslurping. These recovery processes are not effective for complete remediation of soil or groundwater; however, they establish conditions that improve the performance of other remediation processes.

The free-product pool is one of the main sources of petroleum contaminants to soil and groundwater. Removing the LNAPL helps to reduce the concentration and total amount of contaminants in the formation. Because high contaminant concentrations can be toxic to microorganisms, processes that rely on natural biodegradation can work faster when concentrations are reduced. Once LNAPL recovery is accomplished, degradation by natural processes may be sufficient to prevent migration and effectively remediate the site. For example, once LNAPL is removed, residual hydrocarbon contamination in soil can be remediated by using bioventing and groundwater may be amenable to an intrinsic remediation approach.

Typically, LNAPL recovery should be started before remediation of the soil and/or groundwater, but the combination of process options selected and the timing of their implementation can be flexible. Recovering LNAPL may be performed as a first step followed by other remedial process options, as a supplement to soil and/or groundwater remediation occurring during the recovery operation, or as an interim action while processes to remediate soil and groundwater are being evaluated and selected.

3.4 Description of Media Requiring Cleanup

The contaminant of concern for this technology evaluation report is LNAPL consisting of petroleum hydrocarbon fuels and waste oils. These materials are petroleum hydrocarbon products with minor additives specific to the application of the product containing mainly straight-chain and cyclic organic compounds. The size of a hydrocarbon molecule is measured by the number of carbon atoms. The sizes vary from a few carbon atoms to 20 or more carbon atoms. The range of sizes of the hydrocarbon molecules and the different chemical groups attached to the main chain or ring result in a wide range of physical and chemical properties.

3.4.1 LNAPL Chemical Properties

The chemical behavior and environmental fate and transport of the fuel and waste oil hydrocarbons are determined by physical, chemical, and biological mechanisms such as oxidation, reduction, sorption, and biodegradation. The vapor pressures and Henry's law constants for some example fuels are plotted in Figure 3-1. This figure illustrates the physical properties of the compounds that influence the transport mechanisms and fate of fuel and waste oil chemicals.

Fuels and waste oils range from gasoline to heavy fuel oil. Composition ranges for gasoline typically range from 4 to 8% alkanes, 2 to 5% alkenes, 25 to 40% isoalkanes, 3 to 7% cycloalkanes, 1 to 4% cycloalkenes, and 20 to 50% aromatics (0.5 to 2.5% benzene) (U.S. Department of Health & Human Services, 1993a). Diesel fuel contains mainly hydrocarbons with 10 to 19 carbon atoms. The approximate composition ranges for diesel fuels are 64% aliphatics, 1 to 2% olefins, and 35% aromatics. Gasoline and diesel fuels contain less than 5% polycyclic aromatic hydrocarbons (PAHs). Heavier fuels oils contain a higher proportion of hydrocarbons with more carbons in the compound. The

heavier fuels also may contain more than 5% PAHs (U.S. Department of Health & Human Services, 1993b). Jet fuel4 (JP4) is a wide-cut fuel containing petroleum hydrocarbons with carbon chain lengths in the range of 4 to 16. A typical average composition for JP-4 is 32 % normal alkanes, 31 % branched alkanes, 16% cycloalkanes, 18% benzenes and alkylbenzenes, and 3% naphthalenes. Jet fuel-7 (JP-7) is a similar petroleum hydrocarbon fuel but has a narrower boiling range and lower allowed content of aromatic compounds (U.S. Department of Health & Human Services, 1993c).

3.4.2 LNAPL Environmental Fate and Transport

Fuels and waste oils will partition by volatilization, dissolution, or adsorption of individual components depending on their physical and chemical properties. The environmental fate and transport of a fuel or waste oil depend on properties such as vapor pressure, water solubility, and Henry's law constant (U.S. Department of Health & Human Services, 1993a,b,c). Physical and chemical data for some examples of fuel and oil components are listed in Table 3-4 and illustrated in Figure 3-1.

Compounds in a fluid phase can move through the subsurface via various mechanisms. Advection and diffusion are two of the dominant mechanisms. Advection results from a spatial difference in the fluid total potential, which is the sum of the fluid pressure and gravitational potentials. Diffusion results from a spatial difference in chemical potential. Both of these mechanisms and the fluid content-pressure relationships govern the distribution of chemicals and fluid phases in the subsurface.

Before LNAPLs are introduced into the subsurface, a single-phase fluid system exists below the capillary fringe (i.e., a water-saturated system), and a multiphase fluid system exists above the capillary fringe (i.e., an air-water system). Chemicals in the aqueous phase can migrate through the subsurface in response to a gradient in the aqueous-phase total potential (i.e., advection) or by a difference in their aqueous-phase chemical concentrations. Chemicals in the aqueous phase also may partition into the gaseous phase, depending on their vapor pressures for the existing temperature and pressure regime. Once in the gaseous phase, these chemicals can migrate in response to advection and diffusion, which may occur at significantly different rates than in the aqueous phase because the aqueous and gaseous phases may be contained in contrasting pore sizes (Cohen and Mercer, 1993).

Chemicals in the aqueous phase also may partition onto inorganic and organic solids. The adsorption and desorption may be considered to be either instantaneous or controlled by kinetics, i.e., the adsorption and desorption rates may be significantly different. If adsorption and desorption are not instantaneous, then the migration of some chemicals may be retarded, which may affect subsequent remediation strategies. Because many subsurface solids are preferentially wetted by water, the adsorption and desorption of chemicals will occur in association with the aqueous phase. For chemicals to be adsorbed onto solids from the gaseous phase, they must first partition into the aqueous phase.

After LNAPLs are present in the subsurface, another fluid phase must be considered. The LNAPL phase can migrate in response to a pressure gradient. The compounds making up the LNAPL also may partition into the aqueous and gaseous phases and be transported independently of the LNAPL. Therefore, the migration of LNAPL compounds through the subsurface occurs via the gaseous, LNAPL, and aqueous phases (U.S. EPA, 1995, EPA/540/S-95/500). The proportion of LNAPL

Table 3-4. Properties of Example Components of Fuels and Waste Oils

Chemical Class	Compound	Formula	Molecular Weight	Density mg/L (at °C)	Melting Point (°C)	Boiling Point (°C)	Vapor Pressure mm Hg (at °C)	Solubility in Water mg/L (at °C)	
Alkanes	n-Butane	CH ₃ CH ₂ CH ₂ CH ₃	58.12	0.600 (0)	-135	-0.6	760 (-0.5)	61.4 (25)	
	n-Pentane	CH ₃ (CH ₂) ₃ CH ₃	72.15	0.630 (18)	-129.7	36.3	400 (18.5)	40 (25)	
	2-Methylpentane	CH ₃ (CH ₂) ₂ CH(CH ₃) ₂	86.18	0.653 ^(a)	-154	62	200 (24.1)	14 (25)	
	n-Hexane	CH ₃ (CH ₂) ₄ CH ₃	86.17	0.659 (20)	-94	69	100 (15.8)	10 (25)	
	2-Methylhexane	CH ₃ (CH ₂) ₃ CH(CH ₃) ₂	100.21	0.879 ^(a)	-118	90	60 (23)	2 (25)	
	3-Methylhexane	CH ₃ (CH ₂) ₂ CH(CH ₃)CH ₂ CH ₃	100.21	0.887 ^(a)	-119	91	60 (24.5)	4 (25)	
	n-Heptane	CH ₃ (CH ₂) ₅ CH ₃	100.20	0.684 (20)	-90.6	98.4	40 (22.3)	3 (25)	
	2-Methylheptane	CH ₃ (CH ₂) ₄ CH(CH ₃) ₂	114.23	0.698 ^(a)	No data	116	20 (24.4)	No data	
	3-Methylheptane	CH ₃ (CH ₂) ₃ CH(CH ₃)CH ₂ CH ₃	114.23	No data	-120.5	115	20 (25.4)	0.8 (25)	
	n-Octane	CH ₃ (CH ₂) ₆ CH ₃	114.22	0.703 (20)	-56.5	125.7	10 (19.2)	0.8 (25)	
	n-Undecane	CH ₃ (CH ₂) ₉ CH ₃	156.30	0.741 (20)	-25.6	194.5	1 (32.7)	0.04 (25)	
	n-Dodecane	CH ₃ (CH ₂) ₁₀ CH ₃	170.33	0.751 (20)	-9.6	214.5	1 (47.8)	0.004 (25)	
	n-Tetradecane	CH ₃ (CH ₂) ₁₂ CH ₃	198.38	0.765 (20)	5.5	252.5	1 (76.4)	0.002 (25)	
	Cycloalkanes	Methylcyclopentane	C ₆ H ₁₂ CH ₃	84.16	0.749 ^(a)	-142	72	100 (17.9)	42 (25)
Cyclohexane		CH ₂ (CH ₂) ₄ CH ₂	84.16	0.779 (20)	6.5	80 - 81	100 (25.5)	60 (25)	
Methylcyclohexane		CH ₂ (CH ₂) ₄ CH ₂ CH ₃	98.18	0.769 (20)	-126.3	101	40 (22)	14 (25)	
n-Butylcyclohexane		C ₆ H ₁₁ (CH ₂) ₃ CH ₃	140.27	0.818 ^(a)	-78	178 - 180	No data	No data	
Alkybenzenes	Benzene	C ₆ H ₆	78.11	0.880 (20)	5.5	80.1	78 (20)	1,800 (20)	
	Toluene	C ₆ H ₅ CH ₃	92.10	0.870 (20)	-95.1	110.8	22 (20)	640 (25)	
	Ethylbenzene	C ₆ H ₅ C ₂ H ₅	106.17	0.867 (20)	-94.4	136.2	10 (25.9)	100 (15)	
	o-Xylene	C ₆ H ₄ (CH ₃) ₂	106.17	0.881 (20)	-25	144.4	5 (20)	187 (25)	
	m-Xylene	C ₆ H ₄ (CH ₃) ₂	106.17	0.881 (20)	-47.3	139.3	6 (20)	166 (25)	
	p-Xylene	C ₆ H ₄ (CH ₃) ₂	106.17	0.884 (20)	13	138.4	8.5 (20)	175 (25)	
	1,2,4-Trimethylbenzene	C ₉ H ₈ (CH ₃) ₃	120.19	0.876 (20)	-44	169 - 171	1 (13.6)	1 ^(b)	
	1,3,5-Trimethylbenzene	C ₉ H ₈ (CH ₃) ₃	120.19	0.865 (20)	-45, -52	164.8	1 (9.6)	1 ^(b)	
	Naphthalenes	Naphthalene	C ₁₀ H ₈	128.16	1.145 (20)	80.2	217.9	0.0082 (25)	30 (25)
		1-Methylnaphthalene	C ₁₀ H ₇ CH ₃	142.19	1.025 (14)	-19	244.6	No data	1 ^(b)
	2-Methylnaphthalene	C ₁₀ H ₇ CH ₃	142.19	0.994 (40)	35 - 36	241 - 242	No data	1 ^(b)	

(a) Temperature not specified.

(b) i = insoluble.

Sources: Compiled from Dean, 1992; Lide and Frederikse, 1993; Mackay and Shiu, 1981; and Verschuuren, 1983.

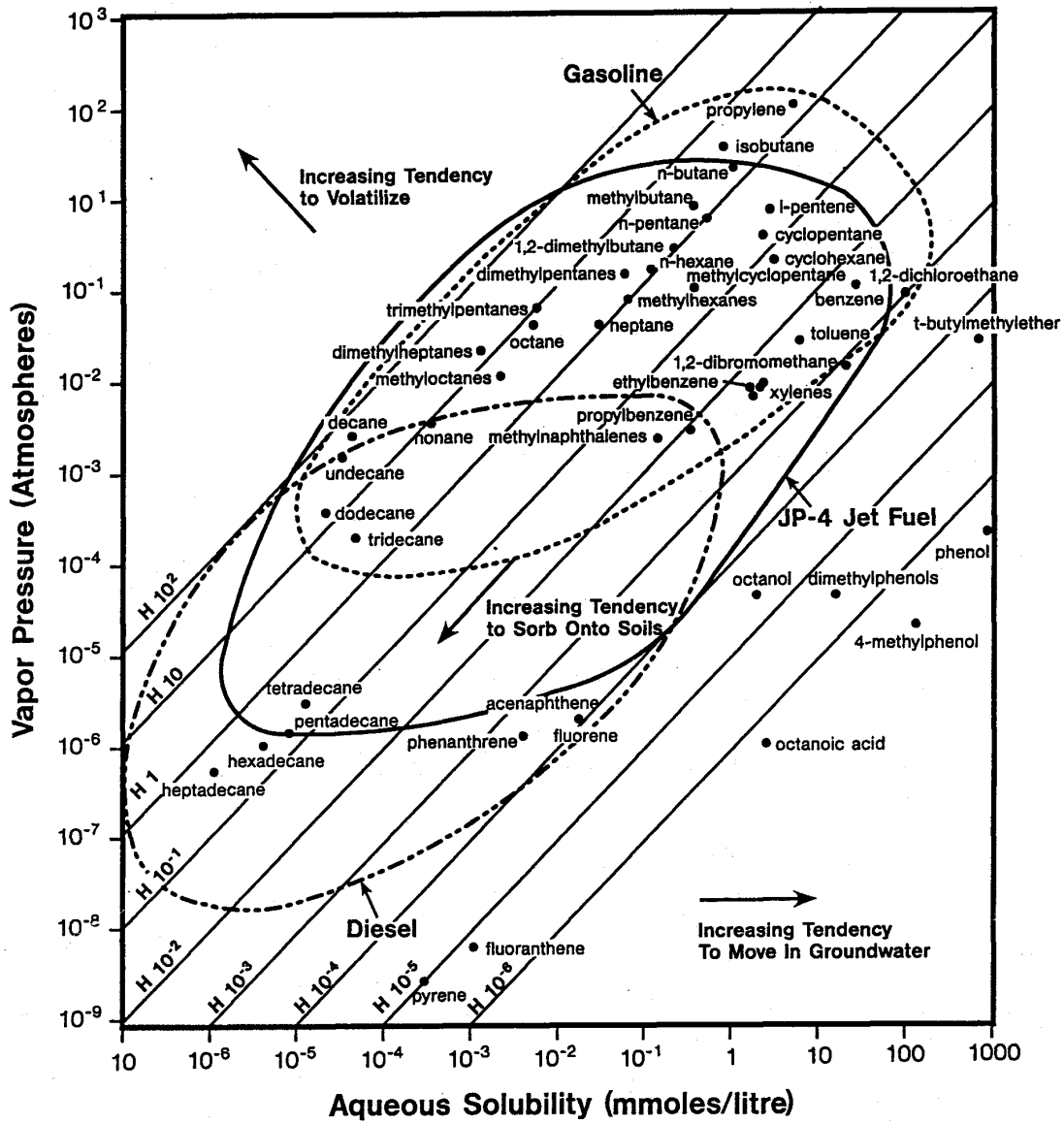

H = Henry's Law Coefficient ($\text{atm} \cdot \text{m}^3/\text{mole}$)

KA/Hinchey/43-02c

Figure 3-1. Effects of Physical and Chemical Properties of Hydrocarbons on Environmental Transport Mechanisms.

compounds that are transported via the gaseous and aqueous phases is a function of the vapor pressure and the aqueous-phase solubility of individual compounds and the spatial differences in gaseous-, LNAPL-, and aqueous-phase pressures. As compounds leave the LNAPL phase and partition into the aqueous and gaseous phases, changes in fluid densities and viscosities must be considered to accurately determine fluid flowrates.

The distribution of fluids in the pore spaces is governed by differences in the fluid pressures at the interfaces between two contiguous fluid phases, i.e., capillary pressures. For an air-LNAPL-water fluid system, the water content is a function of the difference between the LNAPL and aqueous-phase pressures, i.e., the LNAPL-water capillary pressure. The total-liquid content is a function of the difference between the gaseous and LNAPL pressures, i.e., the air-LNAPL capillary pressure. For air-LNAPL-water fluid systems in water-wet subsurface materials, water occupies the smallest pore spaces, gas occupies the largest pore spaces, and the LNAPL occupies the intermediate-sized pores. The distribution of fluid phases in the pore spaces governs the ability of a porous medium to transmit a fluid phase and can affect how an LNAPL migrates below the water-saturated capillary fringe.

LNAPL typically flows down through unsaturated subsurface materials rather uniformly until it encounters the water-saturated capillary fringe. If a sufficient volume of LNAPL has been released, mobile organic liquid may reach the water table. As the LNAPL enters regions with higher water saturation, it tends to spread laterally. Lateral migration is controlled by the LNAPL head distribution. A large accumulation of LNAPL can compress or collapse the capillary fringe and may cause a local water-table depression (U.S. EPA, 1995, EPA/540/S-95/500).

In the subsurface, LNAPL compounds are subject to chemical and microbiological transformations. Depending on the specific compound, the transformations can occur via various pathways. For example, aliphatic hydrocarbons in fuel oils can serve as substrates for a variety of microorganisms and can be chemically altered by both aerobic and anaerobic bacteria. When oxygen is present, longer-chained alkanes are degraded by converting them to longer-chained fatty acids, which are then degraded by beta-oxidation for subsequent complete oxidation. The pathway for anaerobic biodegradation of aliphatic hydrocarbons, however, has not been elucidated as well as the pathway for aerobic degradation. Many microorganisms have evolved biochemical pathways for degrading aromatic hydrocarbons. Benzene rings can be aerobically transformed into organic acids that can be further degraded to carbon dioxide. The microbiological degradation of compounds of benzene, toluene, ethylbenzene, and xylenes (BTEX) has been widely studied, and the specific biochemical pathways have been well characterized. Benzene rings also can be degraded by anaerobic bacteria. Anaerobic degradation produces methane or short-chain organic acids. Anaerobic pathways for organic biodegradation have been studied but not as thoroughly as the pathways for biodegradation by aerobic bacteria (U.S. Department of Health and Human Services, 1993a,b,c).

In summary, LNAPL components can partition from the organic phase into the gaseous and aqueous phases. The quantity of LNAPL components found in a given fluid phase is a function of the components' vapor pressures and chemical solubilities. Once in the gaseous and aqueous phases, the components can migrate through the subsurface in response to diffusive and advective processes. The components also may migrate within the subsurface as a LNAPL by advection. The distribution of LNAPLs in the pore spaces of a porous medium is a function of the differences in the gaseous, aqueous, and LNAPL pressures, i.e., the capillary pressures. Often the rate of transport of petroleum contaminants into groundwater is slower than or equal to the rate of natural biodegradation. The dynamic equilibrium between the source and removal mechanisms explains the tendency of the plume

of fuel constituents in groundwater to quickly reach a stable dimension, effectively containing the contaminant source.

For porous media containing gas, LNAPLs, and water, the LNAPLs will occupy pore sizes larger than those containing water, but smaller than those containing gas. However, for porous media containing only LNAPLs and water, the LNAPLs will occupy the largest pore spaces. LNAPL components also can adsorb onto inorganic or organic solids or be chemically transformed by microorganisms. Thus, the subsurface fate of LNAPLs is very complex and depends on many environmental factors. The sampling and analysis methods described in the bioslurper test plan (AFCEE, 1995a) and the intrinsic remediation protocol (AFCEE, 1995b) provide the information required to understand site-specific fate and transport.

4.0 PRESCREENING OF TECHNOLOGIES

This section describes a range of technologies for recovering floating LNAPL and for remediating organic contaminants in the unsaturated zone. The technologies have been grouped, based on the main operating mechanisms, into LNAPL extraction (Section 4.1), thermally enhanced recovery (Section 4.2), solution delivery and recovery (Section 4.3), air injection and extraction (Section 4.4), biotreatment (Section 4.5), and combined mechanism technologies (Section 4.6). Recent applications of a wide variety of innovative technologies are described in a document titled *Synopses of Federal Demonstrations of Innovative Site Remediation Technologies* (U.S. EPA, 1993, EPA/542/B-93/009). The effectiveness and implementability of the process options available within each of these technology areas are summarized in Table 4-1. Effectiveness for both LNAPL recovery and unsaturated soil remediation are summarized in the table.

4.1 LNAPL Extraction Technologies

Conventional LNAPL extraction technologies recover free organic contaminants by physical collection of free-phase liquids. LNAPL floating on the water table in a well is withdrawn by the suction action of a pump or by selective collection using a skimmer. Successful collection requires a sufficient thickness of LNAPL to supply the collecting device. The conventional processes rely on the gravity-driven advective flow of LNAPL into the well to replenish LNAPL recovered by the pump or skimmer. Different collection technologies or pump configurations may be used to optimize the LNAPL extraction for different in situ conditions. Three types of conventional extraction approaches are used: (1) skimming, (2) single-pump drawdown, and (3) dual-pump drawdown.

The LNAPL extraction device may be located in a well or trench depending on the depth to the water table, the extent of the contamination, geology, and the topography of the site. Interceptor trenches and drains can be used at LNAPL-contaminated sites where the water table is near the surface. The trench is installed downgradient from the LNAPL source to intercept migrating free-phase liquid. LNAPL may migrate to the trench due to natural groundwater movement (skimming), or the flow of LNAPL and groundwater can be enhanced by pumping (single- or dual-pump drawdown) to lower the water table near the trench.

The most important characteristic of the trench is that it intersects the full geologic/hydrologic cross section. The ability of obtaining flow across the full cross section may be advantageous at sites with discontinuous interbedded sands and clays.

Table 4-1. Screening Comments for LNAPL Recovery/Remediation Technologies

Technology/ Section	Effectiveness		Implementability
	Floating LNAPL Removal	Vadose Zone Treatment	
Skimming, Section 4.1.1	Moderate	Low to none	LNAPL Extraction Technologies
			Works best in uniform formations with moderate to high permeability and significant LNAPL thickness
			Recovered oil may contain a small amount of water possibly requiring decanting and disposal of water
Single-pump drawdown, Section 4.1.2	High	Low to none	Uses simple, easily available equipment Commercial technology
			Works best in uniform formations with moderate to high permeability and significant LNAPL thickness
Dual-pump drawdown, Section 4.1.2	High	Low to none	Recovers an oil/water mixture requiring decanting and disposal of water Uses simple, easily available equipment Commercial technology
			Works best in uniform formations with moderate to high permeability and significant LNAPL thickness
Hot water flooding, Section 4.2.1	Moderate	Low	Thermally Enhanced Recovery Technologies
			Works best in uniform formations with moderate to high permeability Recovers an oil/water mixture requiring decanting and disposal of water Requires complex water flow and temperature management Uses moderately complex equipment
Steam/hot air injection, Section 4.2.2	Moderate	High	Widely used for secondary oil recovery but limited use for site remediation
			Works best in uniform formations with moderate to high permeability Recovers an oil/water mixture requiring decanting and disposal of water Off-gas must be collected and treatment usually is required Uses moderately complex equipment Has seen some use for secondary oil recovery but limited use for site remediation

Table 4-1. Screening Comments for LNAPL Recovery/Remediation Technologies (Continued)

Technology/ Section	Effectiveness		Implementability
	Floating LNAPL Removal	Vadose Zone Treatment	
Radiofrequency heating, Section 4.2.3	Low	High	<p>Thermally Enhanced Recovery Technologies (cont'd)</p> <p>Works best in uniform formations with moderate to high permeability Recovers an oil/water mixture requiring decanting and disposal of water High temperature may damage soil properties Off-gas must be collected and treatment usually is required Uses very complex, specialized equipment High cost and poor performance in field tests Requires elaborate clearances from the Federal Communications Commission and the site for use of radioband frequency Innovative technology</p>
Solution flushing, Section 4.3	Low	High	<p>Solution Delivery and Recovery Technologies</p> <p>Works best in uniform formations with moderate to high permeability Controlling flush solution flow in situ can be difficult Flushing solution must be recovered and processed Uses moderately complex equipment Innovative technology with limited field-scale application history</p>
In-well air stripping, Section 4.4.1.1	Low	Moderate	<p>Air Injection and Extraction Technologies</p> <p>Works best in uniform formations with moderate to high permeability Mainly effective for treating plume dissolved in groundwater Air stream from the well must be collected and treatment may be required Uses moderately complex equipment Innovative technology</p>
			<p>Works best in uniform formations with moderate to high permeability Airflow is sensitive to minute variations in permeability Uses moderately complex equipment Innovative technology</p>
			<p>Works best in uniform formations with moderate to high permeability Off-gas must be collected and treatment usually is required Uses simple, readily available equipment Commercial technology</p>
Soil vapor extraction, Section 4.4.2	Moderate ^(a)	High	

Table 4-1. Screening Comments for LNAPL Recovery/Remediation Technologies (Continued)

Technology/ Section	Effectiveness		Implementability
	Floating LNAPL Removal	Vadose Zone Treatment	
Bioventing, Section 4.5.1	Low to none	High	<p>Biotreatment Technologies</p> <p>Works best in uniform formations with moderate to high permeability Uses simple, readily available equipment Commercial technology</p> <p>Works best in uniform formations with moderate to high permeability Effective delivery of oxygen- and nutrient-containing solution in situ can be difficult Uses simple, readily available equipment Innovative technology</p>
		High	
In situ bioremediation, Section 4.5.2	Low to none	High	<p>Combined Mechanism Technologies</p> <p>Works best in uniform formations with moderate to high permeability Recovers an oil/water mixture requiring decanting and disposal of water Off-gas must be collected and treatment may be required Uses simple, easily available equipment Innovative technology Provides horizontal flow path, which can reduce flow resistance in stratified geology</p>
		High	

(a) With high-volatility fuels.

Despite their advantages, trenches are impractical at most sites. Each trench must be excavated to a level below the lowest seasonal water table. Thus, greater water table depth increases the challenge to maintaining the stability of the trench walls. The excavation brings contaminated soils to the surface so treatment and disposal requirements must be addressed. The excavation may disrupt site access roads, utilities, or activities at the site.

Recovery wells are adaptable to a wider range of site conditions. A well recovery system for LNAPL recovery consists of a vertically installed well, or array of wells. The wells are placed over the LNAPL plume area and are screened at the level of the water table.

4.1.1 Skimming

Skimming recovery systems use selective collection devices (skimmers) to collect LNAPL floating on the water table. Floating filter scavenger systems are widely used for skimming floating LNAPL. The floating filter is an oleophilic/hydrophobic mesh with a high affinity for nonpolar hydrocarbons and the ability to reject polar molecules such as water. A mesh cylinder is designed to float in the LNAPL layer in a recovery well. LNAPL floating on the water table passes through the mesh while water is prevented from entering by the mesh. The LNAPL runs down into a collection pot and periodically is discharged by air pressure to a central holding tank on the surface. The pressurization cycle may be controlled by a timer, by high- and low-level switches, or manually.

Shallow wells with low recovery rates can use a rope wick or belt skimmers (Baker, 1995; Hobson, 1996). The rope wick or belt skimmer uses a continuous loop of rope or belt made of an oleophilic/ hydrophobic material. The rope or belt is strung through the LNAPL layer and up through a pair of compression rollers. The rollers provide the motive force for the rope or belt while squeezing out any retained LNAPL into a small container. LNAPL collected in the container periodically is pumped to a central holding tank. Large trench recovery points can be fitted with drum or disk skimmers that are too large to fit into a well.

Skimmer systems withdraw little or no water and produce little or no drawdown and thus have limited pressure head to move LNAPL toward the recovery point. The passive action results in a small radius of influence out from the recovery point. The rate of recovery is low because the skimmer relies on the passive movement of LNAPL into the product recovery wells or trenches.

Despite the low LNAPL recovery rate, skimmers are popular due to several desirable features. All of the skimmer designs allow recovery of LNAPL with low water content. When using any of the LNAPL recovery technologies, water brought to the surface must be treated and/or disposed of properly, which increases permitting complexity and/or cost in many jurisdictions. The ability of the skimmer to withdraw only small volumes of water along with the LNAPL can reduce costs and operating constraints. High disposal costs and/or capacity limitations for wastewater management favor selection of skimmers. The low water content of the LNAPL and the very small quantity of water withdrawn also reduce the size and complexity of skimmer fluid-handling systems.

Skimmers will recover LNAPL when the thickness of the floating layer is too thin to allow efficient recovery with a pump. A skimmer can recover LNAPL even when the floating layer is less than ¼-inch thick.

Skimmers are sturdy, mechanically simple devices with few moving parts, are simple to install and easy to operate, and are available from a variety of vendors as complete package systems.

4.1.2 Single- and Dual-Pump Drawdown

Pump drawdown LNAPL recovery systems are designed to pump LNAPL and groundwater from recovery wells or trenches. Pumping removes water and lowers the groundwater level near the extraction area (cone of depression). The lower water level in the vicinity of the well produces a gravity head that pushes flow of LNAPL toward the well and increases the thickness of the LNAPL layer in the well. Each foot of groundwater depression provides a driving head equivalent to a pressure difference of 0.45 psi. In most cases, the cone of depression will increase LNAPL recovery rates.

Pumping may be accomplished with one or two pumps. In the single-pump configuration, one pump withdraws both water and LNAPL. The dual-pump configuration uses one pump located below the water table to remove water and a second located in the LNAPL layer to recover LNAPL. A single-pump system reduces capital and operating costs and allows simpler control systems and operation but produces a stream of mixed water and LNAPL that must then be separated.

Drawdown pumping is effective for LNAPL recovery when the aquifer has moderate to high hydraulic conductivity and a thick layer of LNAPL. An aquifer with high hydraulic conductivity gives less flow resistance of LNAPL into the well. A thick layer of LNAPL allows the pumping system to collect a high proportion of LNAPL in relation to the amount of groundwater. For best operation the LNAPL thickness should be sufficient to completely cover the pump suction port.

Drawdown pumping is a commercially available technology that can be easily implemented with conventional pumps in wells or trenches. System installation costs are low to moderate, but the cost per amount of LNAPL recovered varies greatly. It is difficult to predict the quantity of recoverable LNAPL using normal site characterization data such as LNAPL levels in wells or soil LNAPL concentration. The quantity recovered may be much higher or lower than initially estimated, resulting in lower or higher cost per unit volume recovered.

4.2 Thermally Enhanced Recovery Technologies

Thermally enhanced recovery technologies apply thermal energy by conduction, convection, and radiation to warm and mobilize contaminants in a formation. Hot water flooding and steam/hot air injection heat mainly by convection, whereas radiofrequency heating uses mainly radiation. Thermal methods are variations of techniques applied or tested to enhance recovery from oil field wells. Hot water flooding and steam injection are commercially applied to recover petroleum products. Hot fluid injection techniques have been tested as alternatives for remediating contaminated sites but have not found wide application. Acceptance has been limited due to their high cost, the need for complex equipment and operating procedures, and concerns about the ability to adequately control and contain in situ flow. Radiofrequency heating originally was developed and tested for heavy oil recovery and has been attempted as a remedial alternative but has been difficult to implement economically in either application.

4.2.1 Hot Water Flooding

Hot water flooding uses hot water and low-quality (high-water-content) steam injection to enhance and control contaminant mobility. Figure 4-1 illustrates an example of hot water flooding technology implementation. The heat of the water and steam flow reduces the viscosity of the oily contaminants encountered, and the flow displaces and floats the nonaqueous-phase liquids toward the extraction

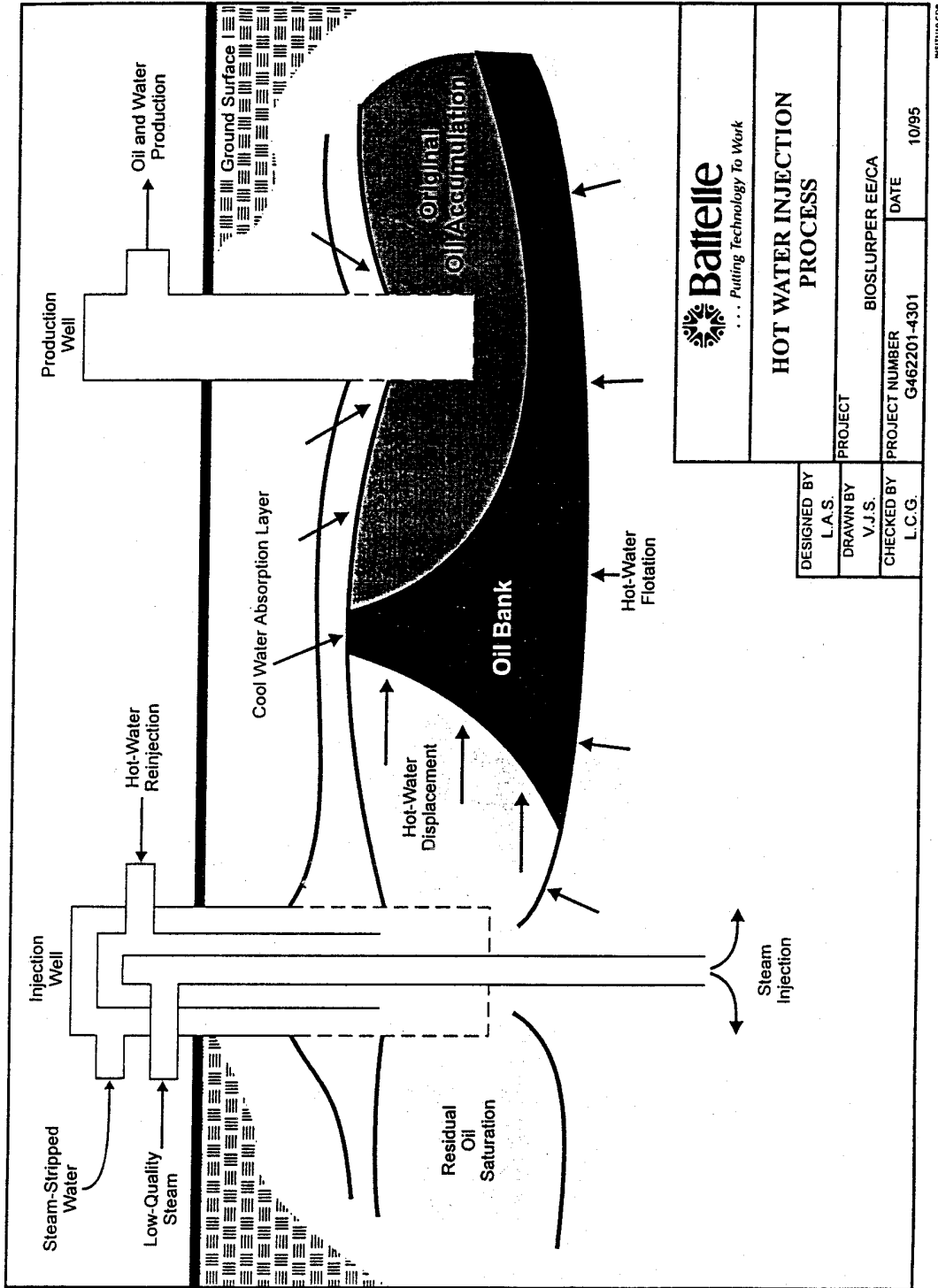

Figure 4-1. Illustration of Hot Water Flooding Technology Implementation.

wells. Hot water flooding is designed to recover dense, nonaqueous-phase liquid (DNAPL) but, theoretically, may be effective for LNAPL recovery as well. As low-quality steam and/or hot water enters and progresses through cool porous media, it heats up the interstitial fluids and porous media. Unlike steam injection (see Section 4.2.2), which relies on a steam front to heat and displace contaminants, hot water flooding uses a water front to mobilize, float, and displace contaminants.

The water flooding system requires a complex well system to simultaneously inject low-quality steam, hot water, and cool water at three separate elevations. Low-quality steam is injected below the contamination to heat the DNAPL. At elevated temperature the DNAPL density is lower than the water density, and the DNAPL is mobilized upward by the hot water. The hot water is injected around the periphery of the contaminated zone to provide lateral confinement and displace the DNAPL toward extraction wells. Cool water is injected above the contaminated zone to create an absorption layer or cold cap. This absorption layer provides vertical confinement of rising pore fluids and condenses any vapors emanating from the heated contaminated zone.

Hot water flooding technology is designed specifically to mobilize heavy tar and similar DNAPLs, but may be effective for LNAPL remediation. One hot water flooding technology has been accepted in the U.S. EPA Superfund Innovative Technology Evaluation (SITE) Demonstration Program (U.S. EPA, 1994, EPA/540/R-94/526). Hot water flooding has been chosen as a component of the remedial technology in Records of Decision (RODs) at one Superfund site (U.S. EPA, 1994, EPA/542/R-94/005).

No cost data were found for hot water flooding, but the cost should be similar to the cost for steam injection (see Section 4.2.2). Hot water flooding is not expected to be cost-competitive in comparison to conventional LNAPL recovery technologies or bioslurping.

4.2.2 Steam/Hot Air Injection

In situ steam injection/extraction removes volatile and semivolatile hazardous contaminants from soil and groundwater without requiring excavation. Figure 4-2 illustrates an example of steam injection technology implementation. Steam injection may be supplemented by hot air injection. In a few experimental studies, hot air or hot combustion off-gas has been injected to strip organics from in situ soil without steam (Smith and Hinchee, 1993, p. 156). Waste constituents are removed from the soil by this process option but are not actually treated. Steam enhances the stripping of volatile contaminants from soil and can be used to displace contaminated groundwater under some conditions.

Steam mixed with organic vapors, contaminated steam condensate and groundwater, and organic liquids is collected in extraction wells for further treatment. The vapor stream is condensed and combined with the water where organic-phase decanting and/or other processing produces a treated water stream and an organic liquid stream. Treated water is often recycled to the steam generator to be reheated and injected. The NAPL is collected for treatment, disposal, or reuse. Application of steam/hot air injection and extraction relies on the ability to deliver, control the flow, and recover the heating fluid.

Steam extraction is effective for treating less-volatile organic compounds that are not efficiently removed by ambient-temperature soil vapor extraction. Increasing the temperature from ambient conditions to the steam temperature increases the vapor pressure of the contaminants, causing

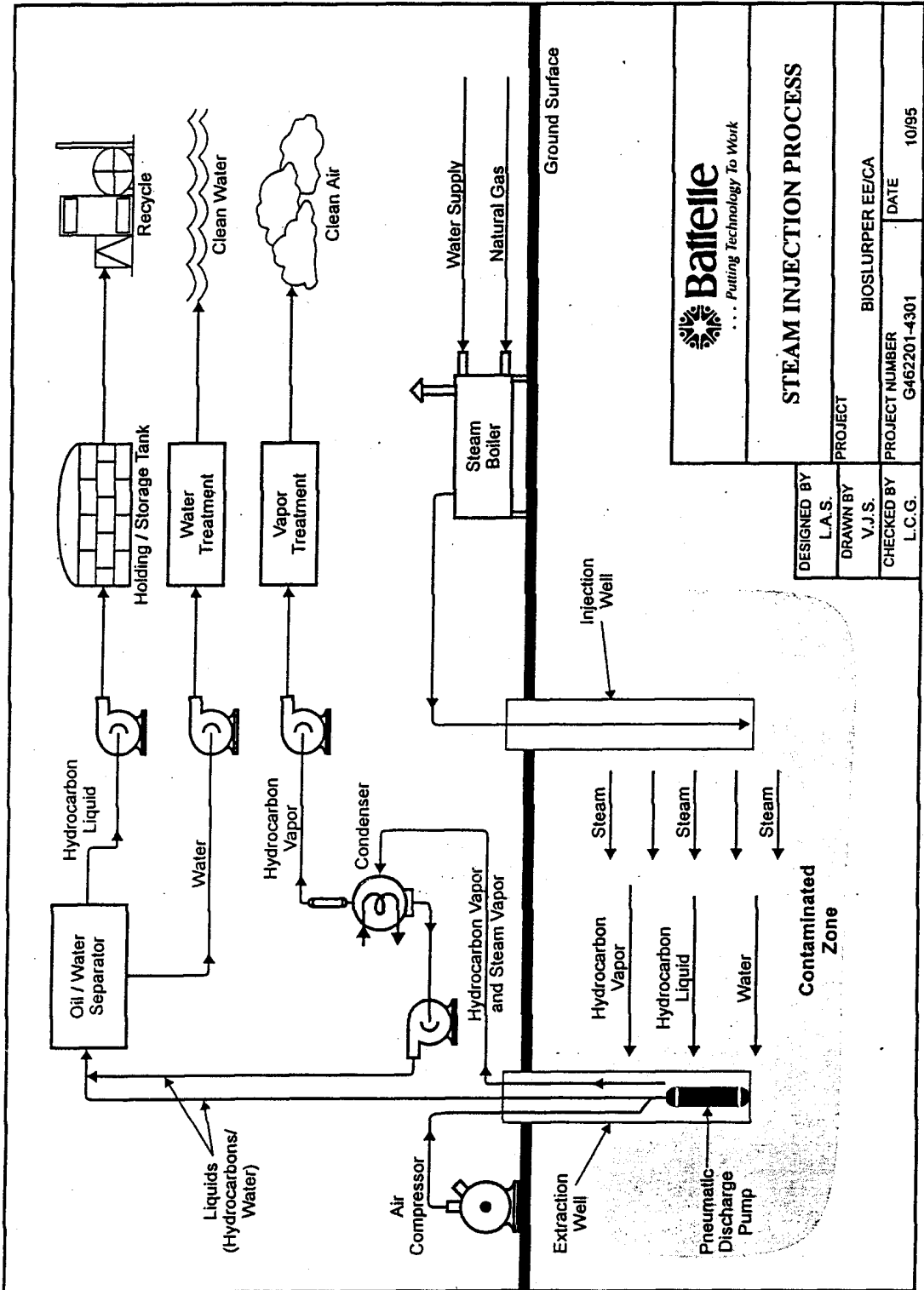



Figure 4-2. Illustration of Steam Injection Technology Implementation.

 ... Putting Technology To Work		STEAM INJECTION PROCESS	
		DESIGNED BY L.A.S.	PROJECT BIOSLURPER EE/CA
DRAWN BY V.J.S.	CHECKED BY L.C.G.	PROJECT NUMBER G462201-4301	DATE 10/95

them to volatilize into the vapor stream. Some of the injected steam condenses to form a hot water front, which displaces groundwater and organic liquids toward extraction wells.

A limited number of commercial-scale in situ steam injection/extraction systems currently are in operation in the United States, but in situ steam injection/extraction is a rapidly developing treatment approach. A U.S. EPA study of DNAPL remediation technologies indicated that steam injection was the most promising technology for recovery of DNAPL from saturated and unsaturated zones (U.S.EPA, 1994, EPA/600/R-94/120). In situ steam injection/extraction is being considered as a component of the remedy for one Superfund site, the San Fernando Valley in California (Area 1) (U.S.EPA, 1991, EPA/540/2-91/005, p. 6).

Two main types of systems are used: a mobile system and a stationary system. The mobile system consists of a unit that volatilizes contaminants in small areas in a sequential manner by injecting steam and hot air through rotating cutter blades that pass through the contaminated medium. The stationary system uses wells to inject steam into the soil to volatilize and displace contaminants, and extraction wells to collect the displaced fluids. One type of mobile system and four types of stationary systems have been accepted in the U.S. EPA SITE Demonstration Program (U.S. EPA, 1994, EPA/540/R-94/526).

For the mobile steam injection process option, the most significant factor influencing cost is the treatment rate, which is determined primarily by the soil type (soils with higher clay content require longer treatment times), the waste type, and the on-line efficiency. An evaluation of one SITE demonstration indicated costs of \$67 to \$317/yd³ for treatment rates of 10 to 3 yd³/hr, respectively. These costs are based on a 70% on-line efficiency. The costs include consideration of site preparation; equipment purchase, installation, and operation; and demobilization (U.S. EPA, 1991, EPA/540/ A5-90/008, p. 21). The U.S. EPA Vendor Information System For Innovative Treatment Technologies (VISITT) database, Version 4, contains data from six vendors of steam injection systems and one vendor of a hot air injection system. The treatment cost range reported by the vendors is \$10 to \$145/yd³ (U.S. EPA, 1994, EPA/542/R-94/003).

4.2.3 Radiofrequency Heating

Radiofrequency (RF) heating is a technique for rapid and uniform heating of large volumes of soil in situ. Figure 4-3 illustrates an example of RF heating technology implementation. This technique heats the soil to the point where volatile and semivolatile contaminants are vaporized into the soil pore space. Vented electrodes are then used to recover the gases.

The extracted gases can be incinerated or processed by other treatment methods. Application of RF heating relies on efficient electromagnetic coupling of the RF source and the media being heated.

RF heating is accomplished by use of electromagnetic energy in the radiofrequency band. The heating process does not rely on the thermal conductivity of the soil. The energy is introduced into the soil matrix by electrodes inserted into drilled holes. The mechanism of heat generation is similar to that of a microwave oven. A modified radio transmitter serves as the power source, and the industrial, scientific, and medical band provides the frequency at which the modified transmitter operates. The exact operational frequency is obtained from an evaluation of the areal extent of contamination and the dielectric properties of the soil matrix.

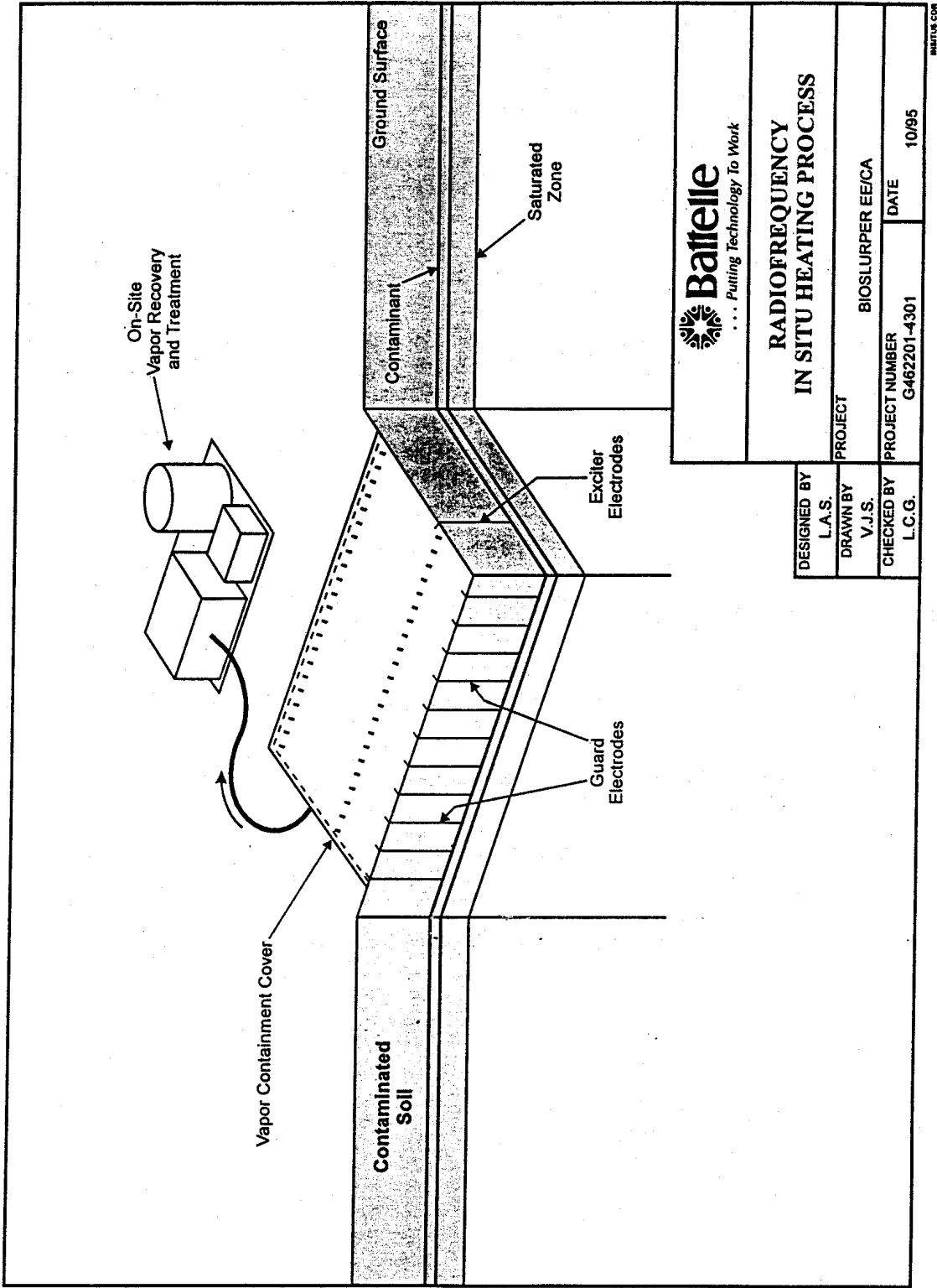

 ... Putting Technology To Work		RADIOFREQUENCY IN SITU HEATING PROCESS	
		PROJECT BIOSLURPER EE/CA	DATE 10/95
DESIGNED BY L.A.S.	DRAWN BY V.J.S.	PROJECT NUMBER G462201-4301	DATE 10/95
CHECKED BY L.C.G.	<small>BAH/TLK/COM</small>		

Figure 4-3. Illustration of Radiofrequency Heating Technology Implementation.

Full implementation of an RF heating system at a contaminated hazardous waste site requires four major subsystems.

- A radiofrequency energy radiation array
- Radiofrequency power generating, transmitting, monitoring, and control systems
- A vapor barrier and containment system
- A vapor recovery and treatment system.

RF heating is difficult and expensive to implement, primarily because the equipment is expensive and the instruments are complex to operate. The RF field couples with the water in soil to transfer energy. The electrical properties of the soil change radically as it dries during heating, so an elaborate and complex tuning system is needed to maintain energy transfer (Smith and Hinchee, 1993). Even if optimal tuning is maintained, energy transfer efficiency decreases substantially if the dried soil does not contain RF-susceptible materials such as montmorillonite clay or iron oxides (Edelstein et al., 1994).

Conventional well materials are not suitable so expensive, high-performance plastics may be required to contain the RF heating electrodes. Because metals block transmission of RF energy, the well materials cannot be metal, but RF heating can elevate the in situ temperature sufficiently to melt typical low-cost well materials such as PVC.

RF transmissions leaking from the system can interfere with communications. Clearances for use of radioband frequencies must be obtained from the Federal Communications Commission (FCC) and the communications personnel on base. Shielding may be required to prevent interference.

RF heating originally was developed and tested for recovery of heavy oil. A U.S. EPA study of DNAPL remediation technologies indicated that RF heating may be effective for removal of DNAPL from the unsaturated zone, but that the technology had not been demonstrated for treatment of the saturated zone (U.S. EPA, 1994, EPA/600tR-94/120). Three treatability tests of RF heating have been performed. The first test was conducted at Volk Air National Guard Base, Camp Douglas, Wisconsin. The contaminants were in a fire training area where waste oils, fuels, and other hydrocarbons had been placed and ignited to simulate aircraft fires. The treated volume was 500 ft³ heated to a depth of 7 feet (Dev et al. 1989, p. 1). The second test, performed at Rocky Mountain Arsenal heated a 1,600-ft³ volume to depth of 13 feet to treat organo-chlorine pesticides and organo-phosphorus compounds (Roy F. Weston and IIT, 1992, p. 2-1). A demonstration of a phased-array radiofrequency antenna system to heat unsaturated zone clay deposits contaminated with chlorinated hydrocarbons was completed at the DOE Savannah River Laboratory (Kasevich et al., 1993, p. 23). Two implementations of RF heating have been tested in the SITE Program (U.S. EPA, 1994, EPA/540/MR-94/527; U.S. EPA, 1994, EPA/540/MR-94/528).

Two vendors report an estimated RF heating treatment cost range of \$50 to \$200/yd³ in VISITT, Version 4 (U.S. EPA, 1994, EPA/542/R-94/003).

4.3 Solution Delivery and Recovery Technologies

Soil flushing is the only solution delivery and recovery technology considered in the preliminary screening. Soil flushing uses injection and extraction of aqueous solutions to remove contaminants from the subsurface without excavation of the contaminated materials. Figure 4-4 illustrates an example of soil flushing technology implementation. Contaminant removal occurs due to a

combination of fluid displacement and increased solubilization. The flushing solution must be selected to remove the contaminant while not harming the in situ environment. Use of the flushing solution must be consistent with land disposal restrictions and other regulatory requirements. Four major elements are considered in application of in situ flushing (Palmer and Wittbrodt, 1991):

- Delivery of the extraction fluid to the required subsurface volume
- Interaction between the extraction fluid and the contaminant
- Recovery of the contaminant and extraction fluid from the subsurface
- Treatment of the recovered contaminant and fluid.

Soil flushing is a process where the zone of contamination is flooded with an appropriate washing solution to remove inorganic or organic contaminants from the soil. The flushing solution is injected into or sprayed onto the area of contamination, and the contaminated elutriate is collected and pumped to the surface for removal, recirculation, or onsite treatment and reinjection. The types of flushing solutions tested or considered as possibly effective for organic removal include dilute water solutions of surfactants, polymers, or alkaline salts (e.g. sodium carbonate, sodium silicate, or sodium hydroxide).

Soil flushing is an innovative technology that has seen some acceptance for remediation of organic contaminants. Flushing has been chosen as a component of the remedial technology in RODs at more than 16 Superfund sites (U.S. EPA, 1994, EPA/542/R-94/005).

The technology may be easy or difficult to apply, depending on the ability to flood the soil with the flushing solution and to install collection wells or subsurface drains to recover all of the applied solution. Provisions must be made for ultimate disposal of the elutriate. The achievable level of treatment varies and depends on the contact of the flushing solution with contaminants, the appropriateness of the solution for contaminants, and the hydraulic conductivity of the soil.

Soil flushing to remove organic materials has been demonstrated at both bench and pilot scale. Studies have been conducted to determine the appropriate solvents for mobilizing various classes and types of chemical constituents. Several systems are in operation and many systems are being designed for remediation of Superfund sites.

Estimated costs for application of soil flushing range from \$75 to \$200/yd³, depending on the waste quantity. These are rough estimates and are not based on field studies (U.S. EPA and U.S. Air Force, 1993). The Superfund site at Palmetto Wood, South Carolina cited costs of \$3,710,000 (capital) and \$300,000 (annual operation and maintenance). These totals, on a unit basis, equal \$185/yd³ for capital costs and \$15/yr for operation and maintenance (U.S. EPA, 1990, EPA/600/2-90/011). The VISITT database, Version 4, contains data from one vendor of soil flushing systems. No treatment cost data are provided (U.S. EPA, 1994, EPA/542/R-94/003).

4.4 Air Injection and Extraction Technologies

Air injection and extraction technologies induce advection of air through the in situ soil mass by application of a pressure difference. The pressure difference can be created by application of pressure, vacuum, or both. The airflow improves soil and/or groundwater aeration and thus causes some degradation of organic contaminants by biological activity. However, the main removal mechanism is the result of vaporization.

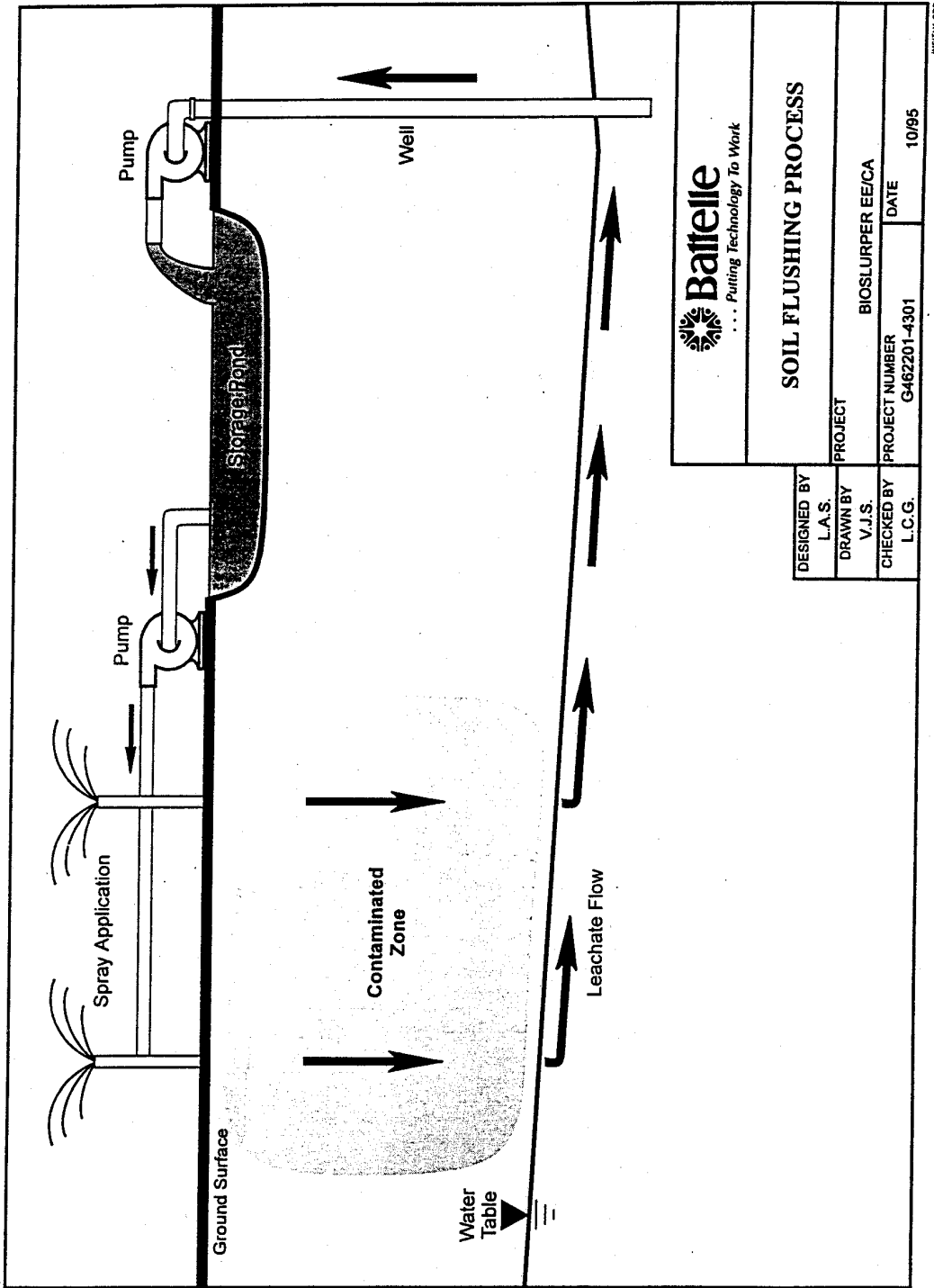

 ... Putting Technology To Work	
SOIL FLUSHING PROCESS	
DESIGNED BY	PROJECT
L.A.S.	BIOSLURPER EE/CA
DRAWN BY	PROJECT NUMBER
V.J.S.	G462201-4301
CHECKED BY	DATE
L.C.G.	10/95

WAT101.CDR

Figure 4-4. Illustration of Soil Flushing Technology Implementation.

4.4.1 Air Sparging

The term *air sparging* is widely applied to the technology of introducing air (or other gases) beneath the water table to promote site remediation. For contaminant treatment, air sparging relies on two basic mechanisms working either alone or in tandem: biodegradation and volatilization. In most cases air sparging is, therefore, a hybrid technology, being both physically and biologically based. In practice, "air sparging" can refer to two apparently similar, yet uniquely different processes (Hinchee, 1994). In the first, clean air is injected at the bottom of a groundwater well in order to strip contaminants and circulate groundwater near the well (Herrling et al., 1994). In-well aeration is referred to as UVB from the German *Unterdruck-Verdampfer-Brunnen*, translated as vacuum vaporizer well or in-well air stripping. In the second, clean air is injected directly into an aquifer (Johnson, 1994). Air injection directly into the aquifer is referred to as in situ air sparging (IAS). Air sparging has been chosen as a component of the remedial alternative in RODs at nine Superfund sites. The reference (U.S. EPA, 1994, EPA/542/R-94/005) did not indicate whether the in-well or in situ systems were selected.

When air sparging is applied, the result is a complex partitioning of contaminants among adsorbed, dissolved, and vapor states. Also, a complex series of removal mechanisms is introduced, including the removal of volatiles from the unsaturated zone, biodegradation, and the partitioning and removal of volatiles from the liquid phase. The mechanisms responsible for removal are dependent on the volatility of the contaminants. With a highly volatile contaminant, the primary partitioning is into the vapor phase and the primary removal mechanism is volatilization. By contrast, contaminants having low volatility will tend to partition into the adsorbed or dissolved phase and the primary removal mechanism is through biodegradation.

4.4.1.1 In-Well Air Stripping. In-well aeration and the WB-type processes represent improvements on or new versions of conventional pump-and-treat technologies. In-well aeration has the potential to be more cost-effective and efficient than conventional pump-and-treat technology but will be subject to similar limitations. Much is to be learned about specific applications of in-well aeration, particularly regarding the questions of radius of influence and groundwater flow regime. The basic mechanisms controlling the process appear to be understood. Figure 4-5 illustrates an example of in-well air stripping technology implementation.

The UVB process involves injecting gas, usually air, into a well, resulting in an in-well airlift pump effect. Air injection in the well at a level below the water table decreases the average fluid density in the deeper portions of the well. Due to the lower density, the air/water mixture rises. At a level in the well above the water table, the air (and contained volatiles) separates from the groundwater and exits the well. The groundwater flows out of the upper screened portions of the well above the water table and migrates down to the lower screened portion of the well. The air injection provides an airlift pumping action and air stripping to remove volatiles. The airlift pumping effect establishes a circulation pattern of oxygen-saturated water in the aquifer that may enhance the biodegradation rate.

One in-well air stripping technology has been accepted in the U.S. EPA SITE Demonstration Program (U.S. EPA, 1993, EPA/540/R-93/526). The VISITT database, Version 4, contains information from one vendor of an in-well air stripping technology. No treatment cost data are reported (U.S. EPA, 1994, EPA/542/R-94/003).

4.4.1.2 In Situ Air Sparging. The IAS process involves injecting air under pressure below the water table to create a transient air-filled porosity by displacing water in the soil matrix. Figure 4-6

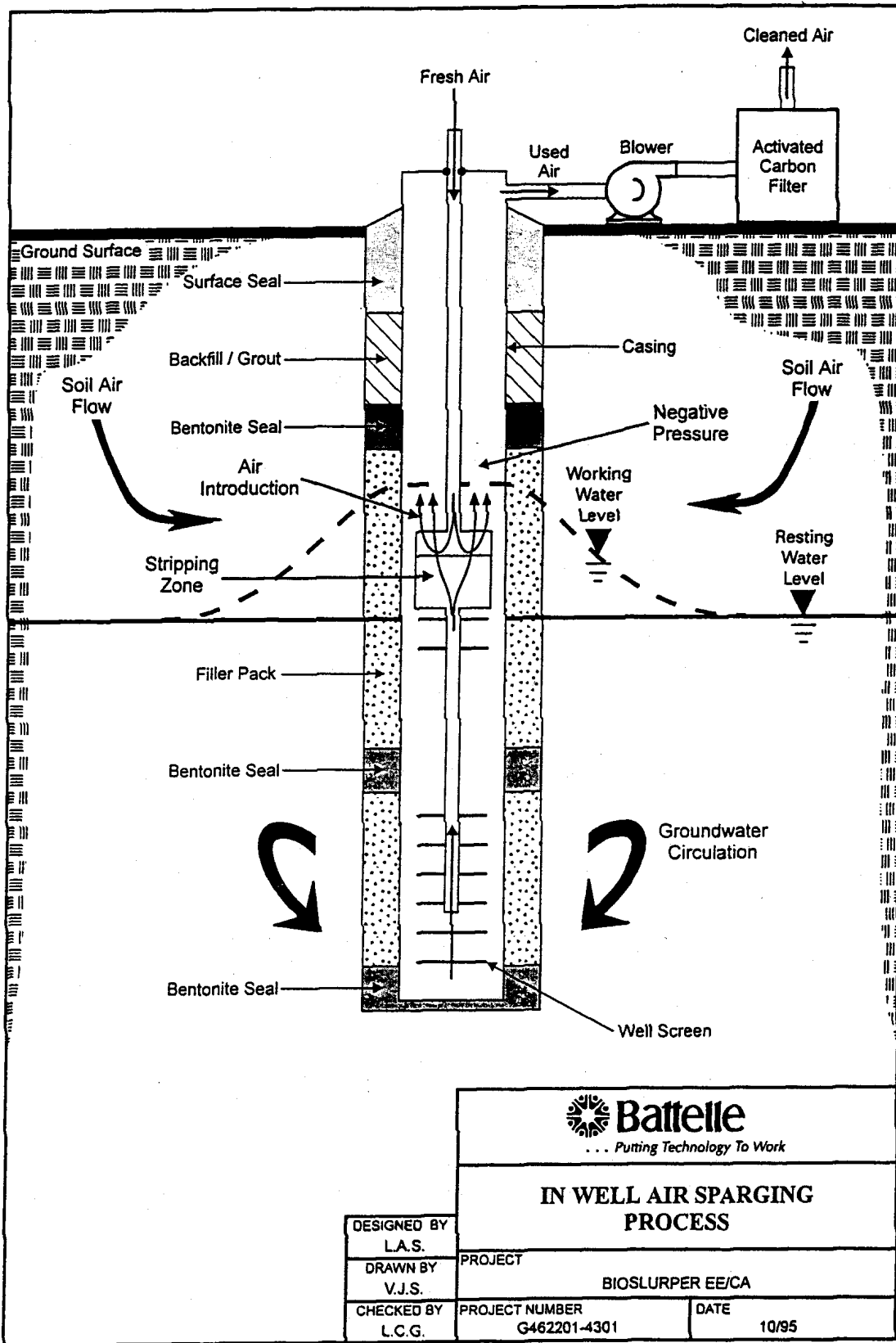



Figure 4-5. Illustration of In-Well Air Stripping Technology Implementation.

 ... Putting Technology To Work		
IN WELL AIR SPARGING PROCESS		
DESIGNED BY L.A.S.	PROJECT BIOSLURPER EE/CA	
DRAWN BY V.J.S.	PROJECT NUMBER G462201-4301	DATE 10/95
CHECKED BY L.C.G.		

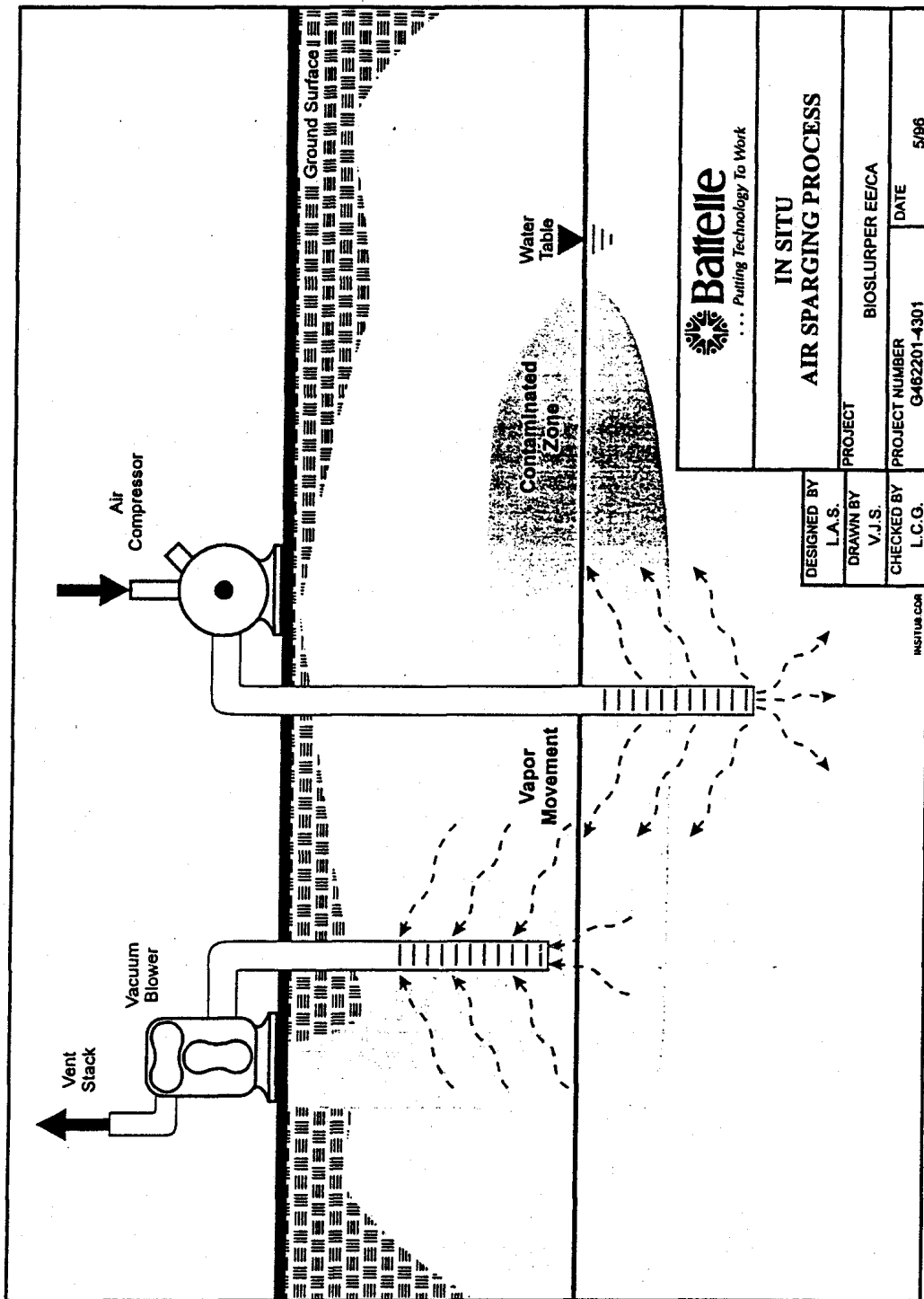

Figure 4-6. Illustration of In Situ Air Sparging Technology Implementation.

illustrates an example of in situ air stripping technology implementation. Air sparging is a remediation technology applicable to contaminated aquifer solids and unsaturated zone materials. This is a relatively new treatment technology which enhances biodegradation by increasing oxygen transfer to the groundwater while promoting the physical removal of organics by direct volatilization.

In situ air sparging remediates groundwater by a combination of volatilization and enhanced biodegradation. The induced air transport through the groundwater removes more-volatile and less-soluble contaminants by physical stripping. Increased biological activity is stimulated by increased oxygen availability. For either or both mechanisms to operate efficiently there must be good contact between the injected air and the groundwater. The behavior of sparging air in situ will be influenced by both the overall average of the permeability and the spatial distribution of heterogeneities in permeability. Information on the distribution and flow configuration of the injected sparging air is essential to interpreting performance of air sparging systems and evaluating their potential applicability. However, the behavior of sparging air introduced below the water table is not well understood.

A significant problem in treating the unsaturated zone by soil venting or bioventing is inducing flow and mass transfer in the capillary fringe. Injecting pressurized air below the water table may be a more efficient for inducing airflow in the unsaturated zone than the more conventional bioventing configuration that provides air injection or extraction wells only in the unsaturated. Leeson et al. (1993) used air injection below the water table to improve airflow for bioventing. One in situ air sparging technology has been accepted in the U.S. EPA SITE Demonstration Program (U.S. EPA, 1994, EPA/540/R-94/526).

IAS does present some potential risks. One of the problems in applying air sparging is controlling the process. In bioventing, airflow is induced by air injection at low pressure or by air extraction. In groundwater extraction the groundwater is collected and removed by pumping. In situ contaminant flow in these systems is under better control because the contaminants tend to migrate toward extraction points. By contrast, air sparging systems inject air at or above the local hydrostatic head. The injection of pressurized air can cause water and contaminants to move away from the air injection point. This migration can accelerate and aggravate the spread of contamination.

A second problem with in situ air sparging is accelerated vapor travel. Air sparging can increase the partial pressure of volatile contaminants in the unsaturated zone gas phase and induce gas migration out of the contaminated zone. The combination of increased contaminant concentration and increased gas migration can increase contaminant movement in the unsaturated zone.

The VISITT database, Version 4, contains information from seven vendors of in situ air sparging technologies. The treatment cost range reported by the vendors is \$15 to \$100/yd³ (U.S. EPA, 1994, EPA/542/R-94/003).

4.4.2 Soil Vapor Extraction

In situ soil vapor extraction (SVE) is the process of removing and treating volatile organic compounds from the unsaturated zone. Figure 4-7 illustrates an example combining groundwater removal with submersible pumps and SVE technology. Blowers attached to extraction wells alone or in combination with air injection wells induce airflow through the soil matrix. The airflow strips the volatile compounds from the soil and carries them to extraction wells. The process is driven by partitioning of volatile materials from the solid, dissolved, or nonaqueous liquid phases to the clean air being introduced by the vacuum extraction process. Air emissions from the systems typically are

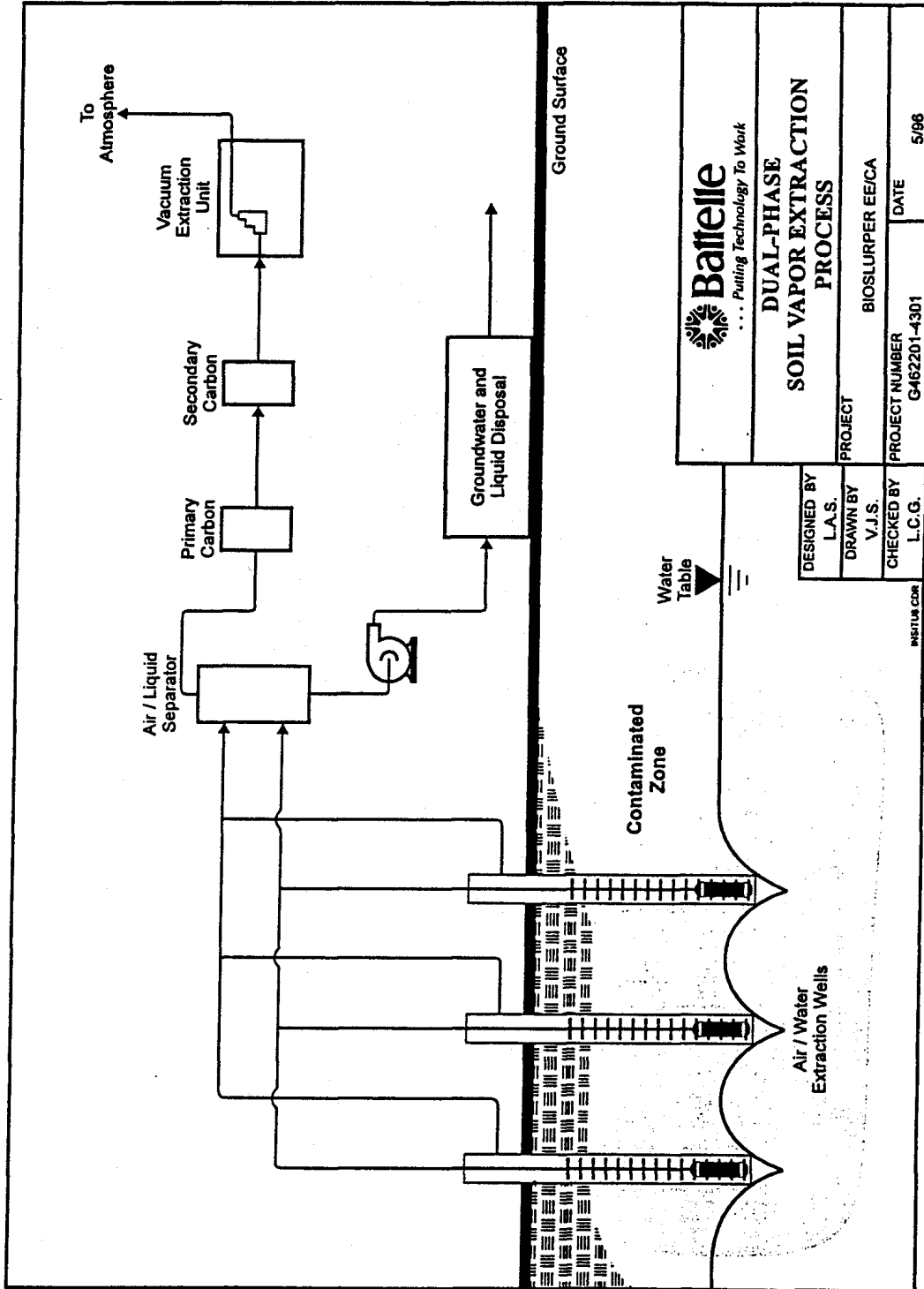

Figure 4-7. Illustration of Combined Groundwater Removal and Soil Vapor Extraction Technology Implementation.

controlled aboveground by adsorption of the volatiles onto activated carbon, thermal destruction (incineration, catalytic oxidation, or internal combustion engine), or condensation by refrigeration (U.S. EPA, 1991, EPA/540/2-91/006). SVE is a developed technology that has been used in commercial operations for several years.

SVE was introduced as an innovative technology. In a regulatory sense SVE is still an innovative alternative to conventional alternatives, but in practice SVE is a fully tested and widely applied commercial technology. It has been chosen as a component of the remedial technology in RODs at more than 120 Superfund sites (U.S. EPA, 1994, EPA/542/R-94/005). Two SVE systems have been tested in the SITE Demonstration Program (U.S. EPA, 1994, EPA/540/R-94/526). SITE demonstrations of soil vapor extraction systems were completed at a Superfund site in Burbank, California (U.S. EPA, 1991, EPA/540/A5-91/002), and at a Superfund site in Groveland, Massachusetts (U.S. EPA, 1989, EPA/540/A5-89/003). A reference handbook on SVE is available (U.S. EPA, 1991, EPA/540/2-91/003), and a detailed approach to the design, operation, and monitoring of SVE systems is described in the literature (Johnson et al., 1990).

The reported estimates of cost ranges are \$15 to \$60/yd³ (U.S. EPA, 1990, EPA/600/2-90/011) and \$27 to \$66/ton (U.S. EPA, 1989, EPA/540/A5-89/003). The cost ranges include consideration of site preparation, equipment purchase, installation, and operation; residual well cuttings disposal; analysis; and demobilization. The high end of the range includes off-gas treatment, whereas the lower cost does not. Off-gas treatment can amount to more than 50% of the total cost of an SVE system (U.S. EPA, 1990, 937.5-06/FS). The VISITT database, Version 4, contains data from eight vendors of soil vapor extraction systems. The treatment cost reported by the vendors ranges from \$15 to \$100/yd³ (U.S. EPA, 1994, EPA/542/R-94/003).

4.5 Biotreatment Technologies

The ultimate goal of biodegradation is to convert organic wastes into biomass and less harmful by-products of microbial metabolism such as CO₂, CH₄, and inorganic salts. In biotreatment processes, microorganisms cause the chemical breakdown of organic compounds. These biological processes may be applied to in situ or ex situ treatment of organic contaminants. The microorganisms may be either indigenous or introduced. In most cases aerobic processes are used, but anaerobic degradation may be beneficial for some compounds.

Successful bioremediation depends on the presence of appropriate microbial populations that can be stimulated to degrade the contaminants of concern by modifying or otherwise managing the environmental conditions at the site. Microorganisms (principally bacteria, actinomycetes, and fungi) make up the most significant group of organisms involved in biodegradation. Microbial communities in the subsurface are diverse and adaptable. Populations at older sites usually are acclimated to the contaminants of concern. Therefore, environmental conditions most often are the major factors limiting the extent and rate of in situ bioremediation. Typically the most important parameters are the availability of an electron acceptor, soil moisture levels, soil temperature, soil pH, and soil nutrients.

Bioavailability is a general term to describe the accessibility of contaminants to the degrading populations. Bioavailability consists of (1) a physical aspect related to phase distribution and mass transfer, and (2) a physiological aspect related to the suitability of the contaminant as a substrate (U.S. EPA, 1993, EPA/540/S-93/501, p. 4). Compounds with greater aqueous solubilities and lower affinity to sorb onto the soil generally are more available to soil microorganisms and are more readily degraded. Bioavailability also depends on the suitability of the compound as a metabolic substrate or

cosubstrate. In general, aerobic techniques are most suitable for remediation of petroleum hydrocarbons, halogenated and nonhalogenated aromatics, polyaromatic hydrocarbons, halogenated and nonhalogenated phenols, biphenyls, organophosphates, and most pesticides and herbicides.

4.5.1 Bioventing

In bioventing processes, a system consisting of injection and extraction wells is used to either push or pull air through the contaminated unsaturated zone. Figure 4-8 illustrates an example of bioventing technology implementation. Airflow increases the availability of oxygen and promotes aerobic biodegradation of organics in the unsaturated zone. Adjustments to the soil moisture content, temperature, or other factors may be used to improve the biodegradation process. Bioventing relies on the ability to move air through the contaminated material. Adjustment chemicals may be applied as aqueous solutions, and modifications may be used to increase the soil temperature.

Delivery of oxygen by water injection is often not feasible because the large amounts of oxygen-saturated water required for biotreatment often cannot be delivered because the hydraulic conductivity of the soil is too low (Dupont et al., 1991, pp. 263-265). Bioventing is, therefore, applicable to sites where limited soil permeability makes the site unsuitable for biotreatment. A bioventing system moves air through the unsaturated zone with a system of vent wells and blowers. Air movement provides an oxygen source to speed metabolism of organic contaminants.

Bioventing is an innovative technology that has been shown to be effective for remediation of petroleum hydrocarbons in the unsaturated zone. It is being applied at hundreds of fuel remediation sites. Bioventing has been chosen as a component of the remedial alternative in RODs at five Superfund sites (U.S. EPA, 1994, EPA/542/R-94/005). The U.S. EPA is demonstrating bioventing as a part of the SITE Demonstration Program (U.S. EPA, 1994, EPA/540/R-94/526).

The VISITT database, Version 4, contains information from 14 vendors of bioventing technologies. The treatment cost range reported by the vendors is \$10 to \$125/yd³ (U.S. EPA, 1994, EPA/542/R94/003).

4.5.2 In Situ Bioremediation

In situ bioremediation involves injection or infiltration of water carrying oxygen and/or nutrients into the undisturbed soil. Adjustments are made to the electron acceptor (such as oxygen) supply, waste moisture content, and nutrient levels to improve biodegradation. Addition of adjustment chemicals generally relies on the ability of aqueous solutions to infiltrate into the contaminated space. Modifications such as surface covers, warm water infiltration, or buried heat tape may be used to increase the soil temperature. Figure 4-9 illustrates an example of in situ bioremediation implementation.

Bioremediation is an innovative technology that has been shown to be effective for remediation of petroleum hydrocarbons in the unsaturated zone. Bioremediation technologies for in situ treatment of organics from three different vendors have been accepted in the U.S. EPA SITE Demonstration Program (U.S. EPA, 1993, EPA/540/R-93/526). In situ bioremediation has been chosen as a component of the remedial alternative in RODs at 16 Superfund sites (U.S. EPA, 1992, 9355.6-05; U.S. EPA, 1994, EPA/542/R-94/005).

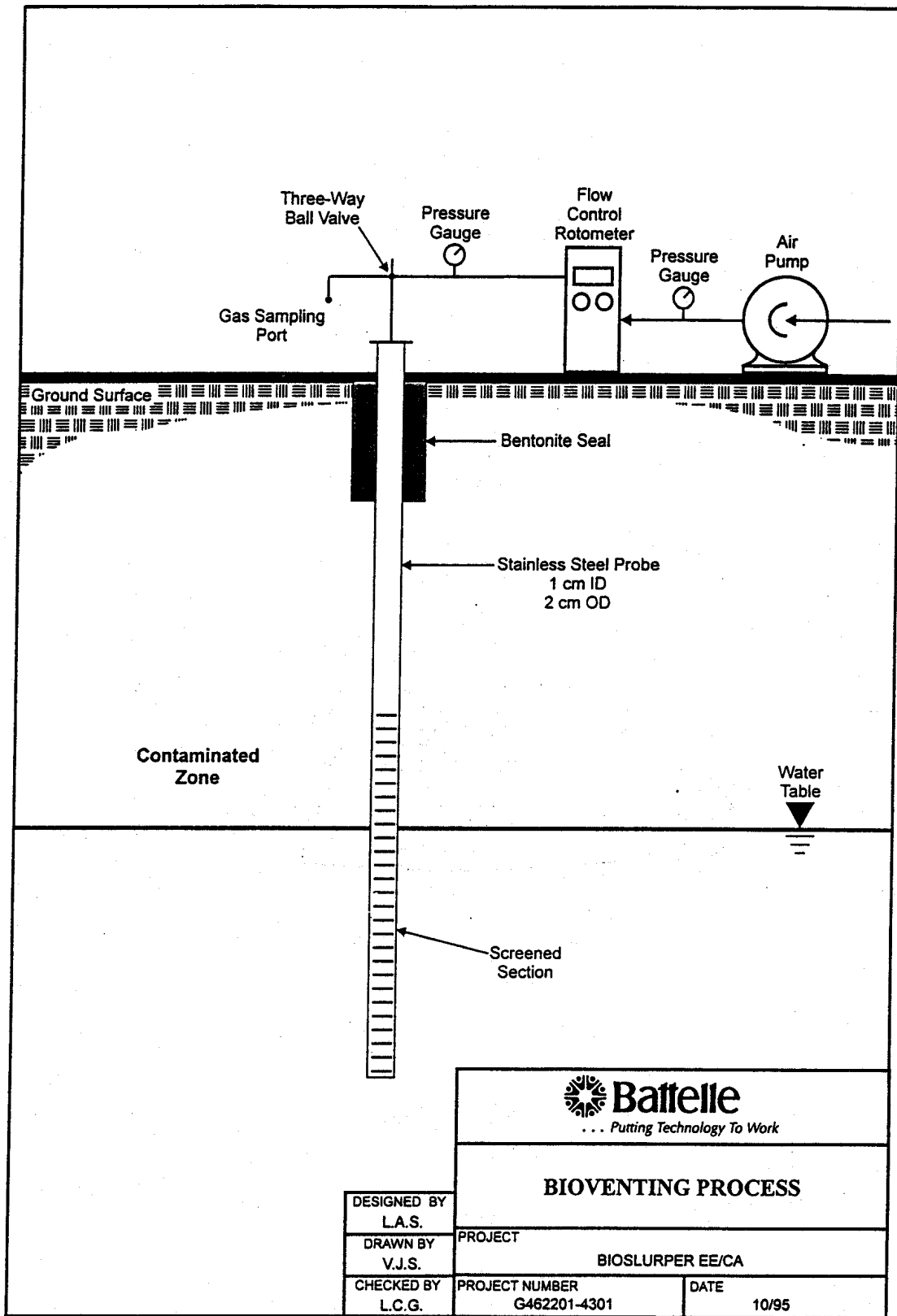
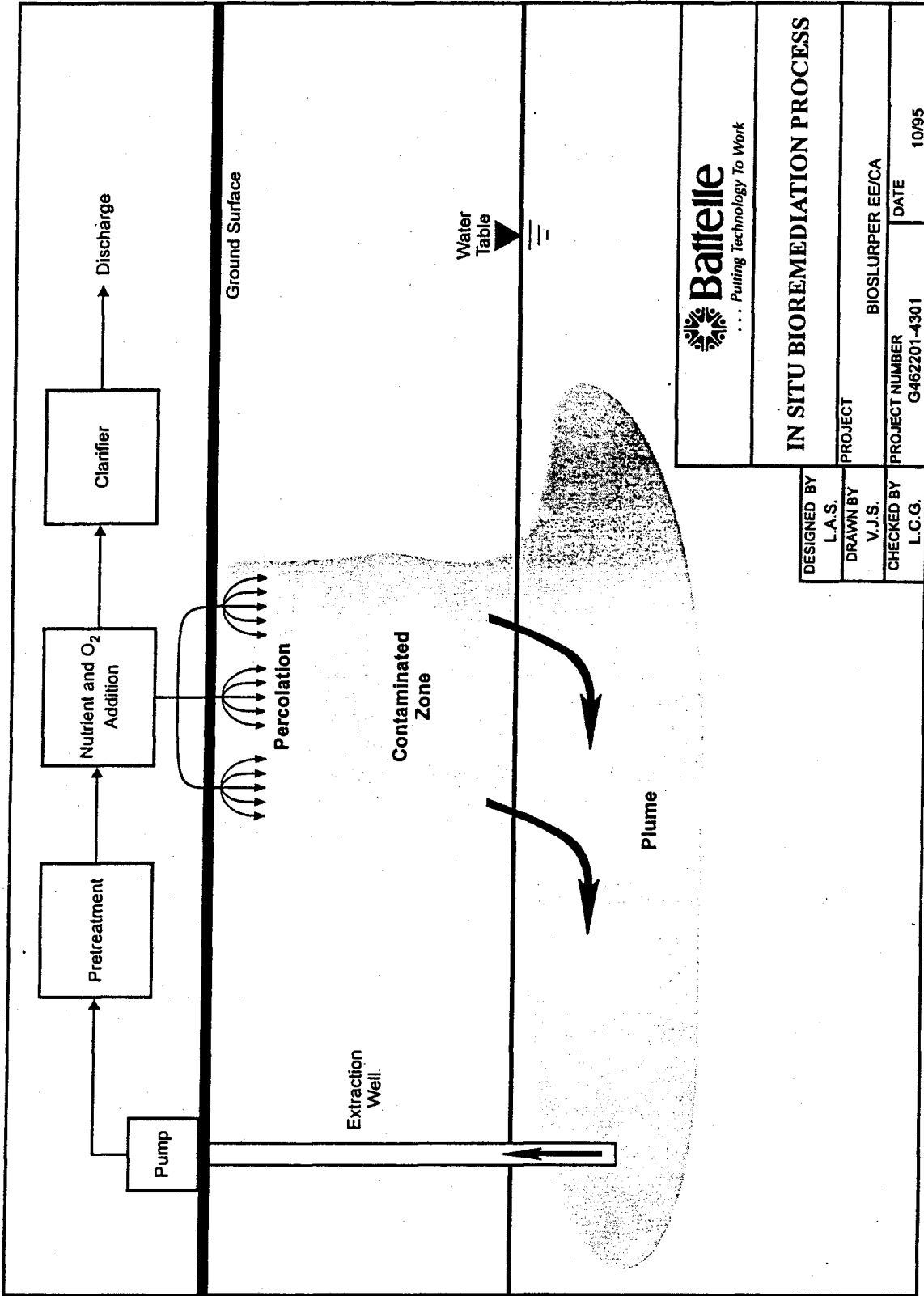



Figure 4-8. Illustration of Bioventing Technology Implementation.



 ... Putting Technology To Work	
IN SITU BIOREMEDIATION PROCESS	
DESIGNED BY L.A.S.	PROJECT BIOSLURPER EE/CA
DRAWN BY V.J.S.	PROJECT NUMBER G462201-4301
CHECKED BY L.C.G.	DATE 10/95

MSR102.COR

Figure 4-9. Illustration of In Situ Bioremediation Technology Implementation.

The reported range of costs for application of in situ bioremediation is \$14 to \$98/ton (U.S. EPA and U.S. Air Force, 1993, p. 60). The VISITT database, Version 4, contains information from 19 vendors of in situ soil bioremediation technologies. The treatment cost reported by the vendors ranges from \$6 to \$250/yd³ (U.S. EPA, 1994, EPA/542/R-94/003).

4.6 Combined Mechanism Technologies

Bioslurping is the only combined mechanism technology considered in the preliminary screening. Bioslurping applies vacuum in an extraction well to recover LNAPL and induce airflow through the unsaturated zone (Keet, 1995). A tube is positioned in a well so the tip of the tube is near the water-table level. Vacuum is applied at the top of the tube to make air flow into the tube, thus entraining LNAPL and water and carrying the fluids up the tube. The process is like sucking on a straw in a nearly empty glass. The groundwater/LNAPL level in the well is rapidly drawn down to the level of the bioslurping suction tube (Connolly et al., 1995). The depth of the tube can be adjusted manually, if needed. The top of the well is sealed so that a vacuum is established in the well. The negative pressure established in the well depends on the air withdrawal rate and the permeability of the surrounding formation. The reference to biological processes in the term bioslurping results from the possibility that aerobic biological degradation of the hydrocarbon will be enhanced due to the introduction of air into the unsaturated zone. Slurping is used in the term to describe the air entrainment and aerodynamic dragging action that lifts fluids up the slurping tube (Barnes and McWhorter, 1995).

Bioslurping may improve free-product recovery efficiency without requiring the extraction of large quantities of groundwater. The bioslurper system pulls a vacuum of up to 20 inches of mercury on the recovery well to create a pressure gradient to force movement of LNAPL into the well. The system is operated to cause very little drawdown of the water-table level, thus reducing the problem of free-product entrapment in soils exposed to LNAPL as the cone of depression forms around a conventional drawdown well.

Bioventing of the unsaturated zone soils is achieved by withdrawing soil gas from the recovery well. The slurping action of the bioslurper system cycles between recovering liquid (free product and/or groundwater) and soil gas. The rate of soil gas extraction is dependent on the recovery rate of liquid into the well. When free-product removal activities are complete, the bioslurper system is easily converted to a conventional bioventing system to complete remediation of the unsaturated zone soils.

Bioslurping combines physical recovery of LNAPL, removal of LNAPL constituents by vaporization (SVE), and mineralization of LNAPL constituents by biological action (bioventing). The rate of mass removal due to each mechanism is strongly dependent on site conditions. The bioventing component can be a strong contributor to the total mass removal. For example, during testing between August and October 1995 at Travis AFB, the approximate rate of removal due to biological action was 240 lb/day based on a biodegradation rate of 61 mg/kg/day (measured by the in situ O₂ utilization rate) and a 55.3-ft radius of influence. The rate of LNAPL constituent removal in the vapor was about 75 lb/day based on an average concentration of 25,250 ppmv and a flowrate of 9 ft³/min. During the same period, the rate of LNAPL recovery for bioslurping ranged from 5 to 30 lb/day with an average of 15 lb/day (Rosansky et al., 1996). The LNAPL removal mechanism proceeded more slowly than the biodegradation or vaporization mechanisms, but the LNAPL would have been difficult or impossible to remove by bioventing or SVE. The combined mechanisms applied in bioslurping allow effective removal of LNAPL in the capillary fringe and floating on the water table while the residual organic in the unsaturated zone is mineralized by biological action and removed by vapor extraction.

LNAPL that is less dense than water (LNAPL) moves downward through the unsaturated zone and accumulates at and above the zone of saturation. The vertical interval containing the accumulated LNAPL also generally contains water and air. Near the top of the LNAPL zone, both water and LNAPL contents are low and most of the pore space is occupied by air. LNAPL contents usually are greatest toward the center of the LNAPL zone and decline to zero at the bottom where the pore space is fully occupied by water.

A significant feature of the bioslurping process is the induced airflow, which in turn induces LNAPL flow toward the well. The pressure gradient created in the air phase results in a driving force on the LNAPL that is significantly greater than that which can be induced by pumping the LNAPL with no airflow. Also of importance is the fact that the airflow created by the vacuum actually enhances the LNAPL content around the well. That is, the LNAPL tends to accumulate or pile up around the well. The accumulation around the well ensures that the permeability controlling the conductivity to LNAPL is maximum. For these reasons, bioslurping has the potential for removing more LNAPL and at greater rates than do other pumping mechanisms (Barnes and McWhorter, 1995).

The flow of LNAPL to a well under a given driving force is dictated largely by the LNAPL conductivity. The single most important influence on the conductivity is the relative permeability of the soil to LNAPL. Relative permeability, in turn, depends strongly on the amount of LNAPL present. Because the LNAPL contents are low at both the top and bottom of the LNAPL zone, the relative permeability to LNAPL also is low at the top and bottom of the LNAPL zone. For this reason, LNAPL removal from these two portions of the LNAPL zone will be minimal, regardless of the quantity of LNAPL that has accumulated.

The quantity of LNAPL is greatest where the permeability is highest. The LNAPL quantity that may exist in this most conductive zone depends on the ratio of thickness of the LNAPL zone to a characteristic capillary pressure head. The feasibility of significant LNAPL recovery is small when this ratio is small. Unfavorable values of this ratio may occur, even when the LNAPL zone thickness is large. Such a circumstance occurs when the characteristic capillary pressure head is large due to very small pore openings, as in low-permeability soils.

In summary, the bioslurping process favorably influences both the driving force on the LNAPL and moving LNAPL through the soil area with the greatest LNAPL saturation which has the highest relative permeability for LNAPL flow. These two features are responsible for the relative success of the bioslurping process. However, tight soils present a compounding unfavorable circumstance for LNAPL removal. First, tight soils have a low capacity to transmit fluid due to their low permeability. This feature is compounded by the fact that LNAPL quantities and relative permeabilities are lower in tight soils, other factors being equal. Thus, the bioslurping process will not be effective in all circumstances, even when the LNAPL zone is thick.

Bioslurper systems are designed to minimize environmental discharges of groundwater and soil gas. As done in bioventing, bioslurper systems extract soil gas at the lowest rate possible while still lifting liquid and maximizing free product movement to reduce volatilization of contaminants. In some instances volatile discharges can be kept below treatment action levels. The slurping action of a bioslurping system greatly reduces the volume of groundwater that must be extracted compared to drawdown LNAPL recovery systems, thus greatly reducing groundwater treatment costs.

4.7 Intrinsic Remediation

If the LNAPL contains minimal concentrations of volatile and water-soluble constituents, the residual product may not have significant adverse effect on groundwater quality or on human health and the environment. The mobility of LNAPL is controlled by factors such as viscosity, density, and permeability. LNAPL trapped by capillary forces is not recoverable by conventional trench, drain, or well systems. High LNAPL viscosity, high residual water saturation, and low permeability reduce LNAPL recovery rates. Under ideal conditions, free-product recovery may remove only 50% of the LNAPL total volume in the subsurface. Under practical field conditions, the expected recovery is 20 to 30% of the LNAPL volume (Catalan and Dullien, 1995; Kaluarachchi, 1996).

At some sites, the maximum achievable LNAPL removal will not significantly reduce the time required to remediate the site, whereas natural processes provide adequate containment and destruction of organic contaminants. The terms *natural attenuation* and *intrinsic remediation* are used interchangeably to describe these natural in situ remediation processes. Natural attenuation includes the biodegradation, dispersion, dilution, sorption, volatilization, and/or chemical and biochemical stabilization of contaminants to effectively reduce contaminant toxicity, mobility, or volume to levels that are protective of human health and the ecosystem. Natural attenuation (or intrinsic remediation) is achieved when naturally occurring attenuation mechanisms bring about a reduction in the total mass of a contaminant in the environment. Natural attenuation results from the integration of several subsurface processes that are either destructive or nondestructive. Biodegradation is the most important destructive process, although several abiotic processes (e.g., hydrolysis) are also capable of contaminant destruction depending on the nature of the contaminant. Examples of nondestructive attenuation mechanisms include sorption, dilution from dispersion and infiltration recharge, and volatilization. For natural attenuation to be a viable remedial alternative for contaminated groundwater, the cumulative effect of the destructive and nondestructive processes must reduce contaminant concentrations to acceptable levels before contaminated groundwater reaches a human or ecological receptor.

4.8 The "No Action" Alternative

The "no action" alternative is considered in every feasibility study to serve as a baseline for comparison. For most sites, taking no action does not adequately protect human health or the environment, nor does it satisfy the ARARs. The "no action" alternative will not recover LNAPL and thus is ruled out for further consideration and is not discussed further in the criteria analyses.

4.9 Results of the Technology Screening

Skimming, single-pump drawdown, dual-pump drawdown, and bioslurping are retained for detailed evaluation. Skimming and drawdown pumping are commercially available technologies for recovery of LNAPL. These conventional approaches establish a baseline for evaluating the effectiveness of using bioslurping to recover LNAPL. Unlike bioslurping, skimming or pumping technologies do not remediate contaminants in the unsaturated zone. At many sites, skimming and pumping technologies would need to be supplemented by SVE, bioventing, or other options to remediate contaminants in the unsaturated zone.

The bases for rejecting the other technologies considered in the preliminary screening are summarized in Table 4-2. Two of the innovative technologies considered in the preliminary screening (hot water flooding and steam/hot air injection) have the potential to recover both LNAPL floating on the water table and LNAPL in the unsaturated zone. Although these technologies have been used to stimulate

Table 4.2. Summary of Reasons for Note Retaining Technologies for Detailed Evaluation

Technology	Reasons for Elimination in the Preliminary Screening
Hot water flooding	Potential to increase contaminant mobility and cause uncontrolled spreading of contamination High cost Implementation not proven at commercial scale
Steam/hot air injection	Potential to increase contaminant mobility and cause uncontrolled spreading of contamination High cost Implementation not proven at commercial scale
Radiofrequency heating	Potential to increase contaminant mobility and cause uncontrolled spreading of contamination Implementation not proven at commercial scale High cost Elaborate FCC and military clearances needed for use of radioband frequencies Does not remove LNAPL as a recoverable phase
Solution flushing	Potential to increase contaminant mobility and cause uncontrolled spreading of contamination Implementation not proven at commercial scale Does not remove LNAPL as a recoverable phase
In-well air stripping	Potential to increase contaminant mobility and cause uncontrolled spreading of contamination Does not remove LNAPL as a recoverable phase
In situ air sparging	Potential to increase contaminant mobility and cause uncontrolled spreading of contamination Does not remove LNAPL as a recoverable phase
Soil vapor extraction	Does not remove LNAPL as a recoverable phase Reconsider if LNAPL recovery rates are low or the fuel volatility is high, or for use in combination with skimming or dewatering
Bioventing	Does not remove LNAPL as a recoverable phase Reconsider if LNAPL recovery rates are low and bioremediation rates are high, or for use in combination with skimming or dewatering
Bioremediation	Potential to increase contaminant mobility and cause uncontrolled spreading of contamination Does not remove LNAPL as a recoverable phase
Intrinsic remediation	Does not remove LNAPL as a recoverable phase Should be reconsidered for use after LNAPL recovery is complete

oil production, their application to remediation of sites contaminated with LNAPL is still in the early stages of development. Both of these technologies use heating to increase contaminant mobility and application of pressure to move the contaminants to collection points. Hot fluid (water or steam) is injected into a formation to push LNAPL to extraction wells. With fluid applied in situ at a pressure higher than the local hydrostatic head, maintaining complete control of contaminant movement may be difficult, particularly if the in situ geology is complex and/or poorly defined. At most contaminated sites there is significant uncertainty about both the extent and location of contaminants and the spatial

distribution of permeability in situ. Remediation methods that involve fluid injection and/or heating to decrease contaminant viscosity and apply elevated pressures to alter in situ flow patterns can have unexpected results when uncertainties exist about in situ conditions. In addition to potentially lower effectiveness and more difficult implementation, both technologies would be expected to be more expensive than pumping, skimming, or bioslurping.

None of the other technologies considered in the preliminary screening can recover LNAPL.

Radiofrequency heating, solution flushing, in-well air stripping, in situ air sparging, and bioremediation raise the in situ pressure over the local hydrostatic head and can increase contaminant mobility.

Radiofrequency heating, solution flushing, in-well air stripping, and bioremediation would be expected to be more expensive than pumping, skimming, or bioslurping.

5.0 LNAPL RECOVERY TECHNOLOGY DESCRIPTION AND COST ESTIMATE

This section describes in more detail the retained technologies of skimming, single-pump drawdown, dual-pump drawdown, and bioslurping to provide a basis for comparing their effectiveness, implementability, and cost. Each of these remedial alternatives consists of extraction wells, a fluid collection system, and a fluid-handling system. The fluid collection and handling system for each technology will include a gravity decanting tank for oil/water separation, two centrifugal pumps (one oil transfer pump and one water transfer pump), and the associated piping. The components are sized using fluid flows estimated from Bioslurper Initiative testing results. Bioslurping systems often require an emulsion-breaking step to supplement the oil/water separator. Bioslurping technology uses a fast moving airstream to lift LNAPL and water. This turbulent transport mechanism thoroughly mixes the two fluids and can result in formation of a moderately stable emulsion. The soil gas extracted during bioslurping creates an off-gas stream that will require treatment to allow release in many jurisdictions. Options for emulsion treatment and off-gas treatment are described for the bioslurping system. The skimming and pumping systems also may require treatment of gas from tanks, but the volume of airflow is small. If needed, small carbon adsorbers could be provided for process vents. The configuration used for the budget cost estimate is described and, where applicable, alternative equipment types and their effects on operating characteristics and costs are discussed.

The cost estimates include costs directly related to installing and operating each system. Cost elements considered in the estimates are site preparation, equipment purchase, equipment installation, startup, operating labor, consumables, electrical usage, effluent treatment, and process monitoring costs. Costs for permitting and regulatory activities, initial site characterization, and analysis to confirm site cleanup are not included. The cost elements that are not included will be significant but will not vary significantly among the technologies studied.

Because this technology evaluation and review is generic (i.e., no specific site is being considered), we have defined a standard base case to provide a basis for estimating costs for the remedial technologies. Design basis assumptions are developed using data from the Bioslurper Initiative. Although site data are used, it is important to understand that the design basis used for the technology evaluation is an artificial construct developed to give a standard for comparing bioslurping with conventional LNAPL recovery technologies. Measurement of site-specific parameters and an on-site treatability test would be required to develop design parameters for an actual site. The main assumptions defining the base case for this technology evaluation report are as follows:

- The LNAPL recovery rates for skimming, drawdown pumping, and bioslurping are 3.1 gal/d, 4.5 gal/d, and 21 gal/d, respectively (averages from Table 5-1).
- The groundwater removal rates for drawdown pumping and bioslurping are 1,640 gal/d and 1,800 gal/d, respectively (averages from Table 5-2).
- Skimming removes essentially no water from the subsurface.
- The off-gas flowrate from the bioslurper system is 65 scfm (9 wells, each producing 7.2 scfm).
- Skimming and drawdown pumping produce negligible off-gas flow.

Table 5-1. Comparison of LNAPL Recovery Rates for Skimming, Pumping, and Bioslurping

Site	Skimming		Drawdown Pumping		Bioslurping
	Sustained LNAPL Recovery Rate (gal/d)	Rate Relative to Bioslurping(a)	Sustained LNAPL Recovery Rate (gal/d)	Rate Relative to Bioslurping	Sustained LNAPL Recovery Rate (gal/d)
Andrews	0.71	0.01	No data	No data	64.2
Bolling (1)	8.20	0.15	31.2	0.52	59.85
Bolling (2)	0.0	0.0	0.126	0.26	0.48
Dover	9.4	0.21	No data	No data	43.2
Edwards	13.0	0.23	No data	No data	55.8
Havre MW-7	0.012	0.16	0.01	0.14	0.073
Hill	0.60	0.4	0.5	0.33	1.5
Johnston Atoll	3.6	0.11	9.0	0.28	32
Kaneohe	0.0	0.0	0.0	0.0	2.39
March MW-04	0.0	-(b)	0.0	-(b)	0.0
I McGuire	6.6	0.22	1.2	0.04	30.0
Robins UST	5.0	0.12	12.0	0.3	40.0
Robins SS010	1.1	0.48	0.36	0.16	2.3
Travis	0.0	0.0	3.59	1.05	3.41
Tyndall MW-5	0.24	1.04	0.68	2.96	0.23
Wright-Patterson	1.48	0.80	0.0	0.0	1.85
Average	3.12	0.26	4.51	0.50	21.1

(a) A ratio less than one indicates that bioslurping gave a higher LNAPL recovery rate than the conventional technology. A zero indicates that the conventional technology was not effective for LNAPL recovery at that test site.

(b) None of the technologies were able to recover LNAPL.

**Table 5-2. Comparison of Groundwater Removal Rates
For Drawdown Pumping and Bioslurping**

Site	Drawdown Pumping		Bioslurping
	Sustained Water Removal Rate (gal/d)	Rate Relative to Bioslurping ^(a)	Sustained Water Removal Rate (gal/d)
Andrews	No data	No data	2,963
Bolling (1)	2,664	0.97	2,751
Bolling (2)	998	0.78	1,286
Dover	No data	No data	2,844
Edwards	No data	No data	563
Harve MW-7	15	0.23	64
Johnston Atoll	1470	1.07	1,375
Kaneohe	21.4	0.53	40.2
March MW-04	3,816	0.81	4,705
McGuire	730	0.16	4,600
Robins UST	2,100	1.65	1,275
Robins SS010	1800	1.30	1,385
Travis	480	1.28	375
Tyndall MW-5	2,207	1.56	1,414
Write-Patterson	2,610	1.44	1,807
Average	1,639	1.04	1,805

(a) A ratio greater than one indicates that bioslurping gave a lower water extraction rate than drawdown pumping.

- The depth to the water table is 25 feet.
- Nine LNAPL extraction wells will be required.
- All systems have the same effective radius.
- All systems require the same length of operating time to recover all available floating LNAPL. (This assumption understates the advantages of bioslurping as discussed in Section 6.3.)
- A water treatment facility is available on site.

The design basis liquid flowrates for skimming, drawdown pumping, and bioslurping are estimated based on LNAPL recovery rates and groundwater removal rates measured during the Bioslurper.

Initiative. The results for LNAPL recovery and groundwater withdrawal are summarized in Tables 5-1 and 5-2, respectively. Table 5-3 indicates the ratio of the groundwater removal rate to the LNAPL recovery rate for each technology. Average rates for LNAPL and water recovery were calculated using data from test sites where useful data were collected for at least two of the recovery technologies. Estimated average rates are needed to provide a basis for comparing the technologies. Due to the wide range of conditions at the sites and the variation of the results, it is also important to compare the relative LNAPL recovery and groundwater removal among technologies at each site. Ratios of fluid flowrates relative to bioslurping are provided in Tables 5-1 and 5-2 to facilitate comparing performance at each site. The same groundwater removal rate is used in the analysis of single- and dual-pump drawdown pumping. In single-pump drawdown, the LNAPL and groundwater will be produced as a single stream. In dual-pump drawdown, two separate streams will be produced. Groundwater was withdrawn during test operation in the skimmer mode; however, the water withdrawal rate does not accurately represent the performance of a skimming system. The groundwater removal rate for skimming is expected to be small based on field performance of the skimming equipment.

Table 5-3. Ratio of Groundwater Removal Rate to LNAPL Recovery Rate for Pumping and Bioslurping

Site	Water to LNAPL Ratio for Drawdown Pumping (gal/day)/(gal/day) ^(a)	Water to LNAPL Ratio for Bioslurping (gal/day)/(gal/day) ^(a)
Andrews	No data	46.1
Bolling (1)	85.4	46.0
Bolling (2)	7,920	2,679
Dover	No data	65.8
Edwards	No data	10.1
Havre MW-	1,500	877
Hill	4,800	955
Johnston Atoll	163	43.0
Kaneohe	No LNAPL recovery	16.8
March MW-4	No LNAPL recovery	No LNAPL recovery
McGuire	608	153
Robins UST	175	31.9
Robins SS010	5,000	602
Travis	134	110
Tyndall MW-5	3,246	6,148
Wright-Patterson	No LNAPL recovery	977

(a) A larger ratio indicates poorer performance. Ratios are calculated from data in Table 2-3 for bioslurping and drawdown pumping.

Estimation of the off-gas flow used for the base case bioslurper system concept and cost estimate is based on the flow measured during the Bioslurper Initiative supplemented by literature data. The average measured off-gas flow is 21.5 scfm (calculated from data in Table 2-3). The expected off-gas flow from a well can be estimated using the method described by Johnson et al. (1990). For 5 feet of open well screen, the estimated airflow ranges from 9.5 scfm for fine sand (permeability 1 darcy) to 0.95 scfm for clayey soils (permeability 0.1 darcy).

Using a fixed number of LNAPL extraction wells does not account for the difference in the effective radius of the collection systems. A larger effective collection radius would reduce the number of wells needed and thus the costs. The skimming system would be expected to have a much smaller effective radius. Bioslurping would have a similar or larger effective radius compared to drawdown pumping. However, these effects were not measured in the Bioslurper Initiative and could not be quantified using literature data. The assumption of a fixed number of wells was used to provide a consistent basis for evaluation.

5.1 Skimming

This section describes the equipment configuration and operating characteristics of the skimming system used as the basis for comparing the candidate LNAPL recovery technologies. Figure 5-1 shows a skimming system using a filter scavenger and pneumatic pump installed in a well. Table 5 shows the estimated capital and operating costs for a skimming system.

5.1.1 Extraction Wells

The extraction wells are constructed of an unslotted PVC riser connected to slotted PVC well screen positioned to intercept the water table. Well piping with a nominal 2-inch diameter will be used.

5.1.2 Fluid Collection System

One LNAPL skimmer recovery system is required in each well. The skimmer uses a polyethylene LNAPL collection filter which holds water out while allowing hydrocarbon to flow through the filter and down into a collection chamber. The filter is guided by a stainless steel shaft and is weighted to float in the hydrocarbon layer. The shaft length allows the filter to move over a range of 2 feet to provide unattended adjustment of the LNAPL collection filter when the water table level moves up and down. A timer periodically applies air pressure to the collection chamber to push any hydrocarbon in the chamber up to the surface. A high-level switch is also provided to trigger the pressurization cycle to ensure that the collection chamber does not overflow.

A rope wick skimmer could be used instead of a filter skimmer. The capital cost for the rope wick system would be the same to about 30% lower than the cost for the filter skimmer. However, the cost difference is not sufficient to have a material effect on the comparison. Also, the rope wick system has several disadvantages that may offset the small potential lower cost. Application of rope wick skimmers to oil recovery from wells is not as well proven as application of the filter skimmer. The rope wick system is limited to a vertical lift of 15 to 25 feet from the LNAPL layer to the collection roller.

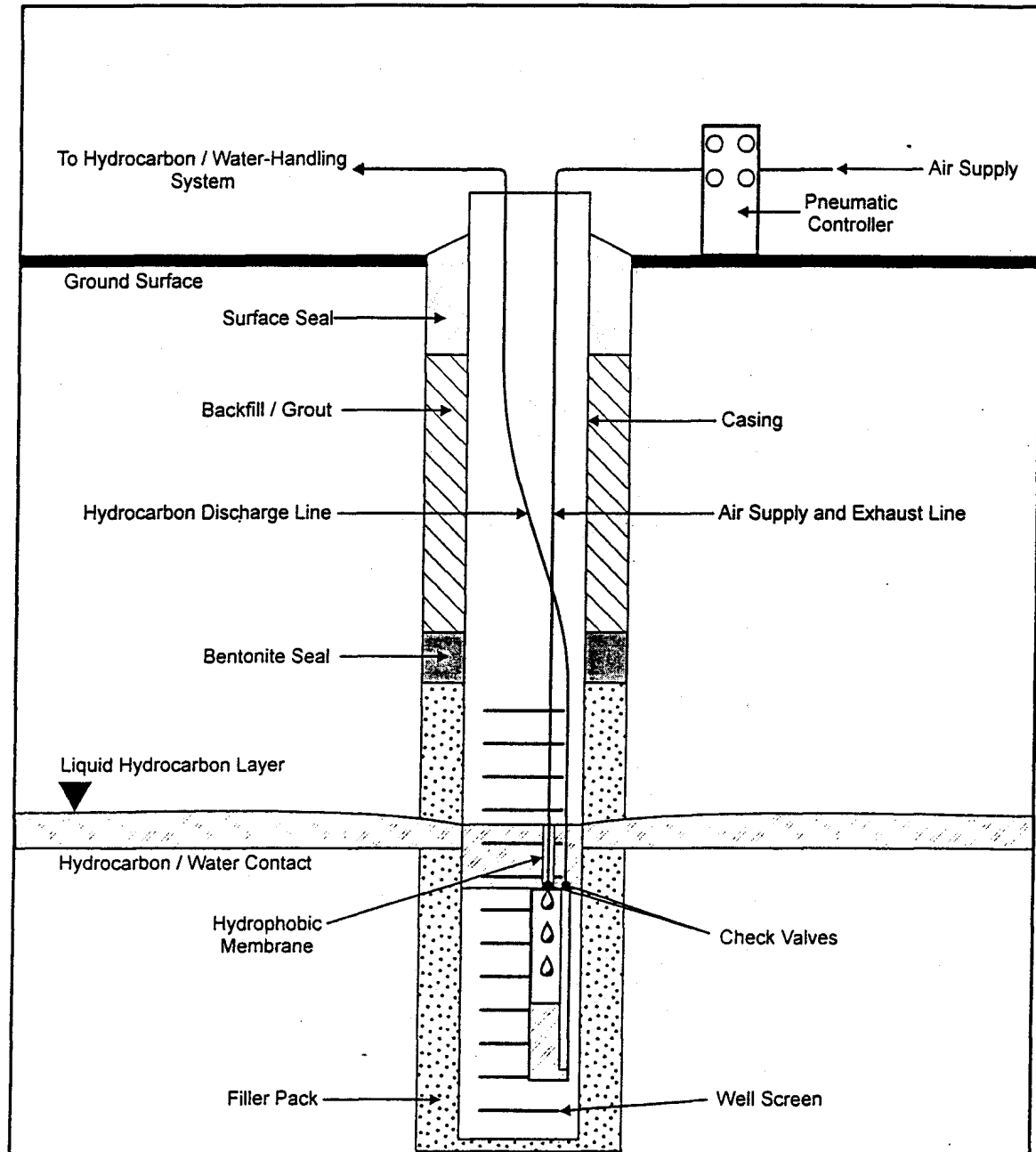

Battelle
... Putting Technology To Work

PNEUMATIC SKIMMING PUMP

DESIGNED BY L.A.S.	PROJECT	
DRAWN BY V.J.S.	BIOSLURPER EE/CA	
CHECKED BY L.C.G.	PROJECT NUMBER G462201-4301	DATE 10/95

EXTRACTS.COR

Figure 5-1. Schematic Diagram of a Skimming System.

Table 5-4. Skimming System Cost Estimate

Item	Costing Basis	Unit Cost ^(a)	Item Cost
Site Preparation			
Electrical Connection	1,000 feet of buried 4-inch-diameter conduit	\$5.00/ft	\$5,000
Grading and Equipment Platform	1,500 ft ² of subgrade and concrete	\$6.00/ft ²	\$9,000
Well Installation	9 wells, 4-inch-diameter PVC casing, 35 feet deep	\$74.15/ft	\$23,360
Equipment (see Figure 5-1)			
Skimmers	9 skimmer systems (skimmer and compressor)	\$4,000	\$36,000
LNAPL Recovery Pipe and Fittings	1,000 feet of 1/2-inch-diameter PVC	\$8.65/ft	\$8,650
Instrumentation	1 group, flow and pressure measurement instruments	\$500	\$500
Oil/Water Separator	1 gravity decanter, capacity 2 gpm	\$1,500	\$1,500
LNAPL Holding Tank	1 polyethylene tank, 300 gal	\$550	\$550
LNAPL Transfer Pump	1 centrifugal pump, capacity 5 gpm	\$620	\$620
Water Holding Tank	1 polyethylene tank, 500 gal	\$760	\$760
Water Transfer Pump	1 centrifugal pump, capacity 5 gpm	\$620	\$620
Water Filter	1 bag filter, capacity 5 gpm	\$380	\$380
Mobilization	Movement of personnel and equipment	\$5,000	\$5,000
Engineering	20% of site, equipment, and mobilization costs		\$18,388
Total Capital Cost			\$110,328
Operation and Maintenance		90% uptime, 648 hours per month	Monthly Operating Cost
Electricity	10 kW	\$0.08/kW-hr	\$520
Testing and Monitoring	9 water analyses per month	\$800/sample	\$7,200
Wastewater Disposal	minimal water production	Not applicable	Not applicable
Operating Labor	20 hours per month	\$50.00/hr	\$1,000
Reporting	1 monthly report and final report (prorated)	\$2,400/month	\$2,400
Total Monthly Operating Cost			\$11,120/month
Total Capital and 6 Months Operating Cost			\$177,048

(a) Unit cost data from Waier (1994), Richardson Engineering Services (1995), and vendor catalogs.

5.1.3 Fluid-Handling System

Air pressure will push LNAPL (possibly mixed with a small amount of water) to an oil/water gravity decanting tank sized for a flow of 2 gal/min. Water flows by gravity from the bottom of the decanter into a collection tank. Water is withdrawn from the collection tank with a centrifugal pump, passed through a bag filter, and discharged. The groundwater removal rate assumed for the base case skimming system concept and cost estimate is minimal. Costing is based on the assumption that the LNAPL content of the decanted groundwater is low enough to allow discharge to a sewer or water treatment plant. The volume of groundwater removed by skimming should be very small so the effect of water disposal on total cost will be minimal. LNAPL is withdrawn from the decanter and collected. The LNAPL recovery rate used for the base case skimming system concept and cost estimate is 3.1 gal/day. Costing is based on the assumption that the LNAPL can be used in a nearby waste-to-energy boiler for a nominal handling charge.

5.2 Single- and Dual-Pump Drawdown

The technology comparison is based on a pumping system using submersible pumps installed in extraction wells. Locating the pumping system at the surface is possible when the water table is near the surface. The surface pump location lowers cost but limits the allowed drawdown depth. The maximum theoretical suction lift is the height of a column of water that can be supported by the local atmospheric pressure (33.8 feet at standard conditions). The practical suction lift is reduced by factors such as net positive suction head required by the pump, the vapor pressure of the pumped fluid, and friction losses in the suction piping. Installing a pump on the surface to lift LNAPL or water from a well is impractical when the level of the water table, including required depression, is deeper than about 20 to 25 feet.

For successful operation of a pump in a well, the casing must accommodate the pump with sufficient clearance to prevent stable vortex formation at the pump suction. As a rule of thumb, the well casing size should be one to two nominal pipe sizes larger than the outside diameter of the pump. A nominal 6-inch-diameter casing is adequate for the range of flowrates typically encountered in NAPL recovery systems (Schleyer, 1987). Pump selection criteria and extraction well design are discussed in detail in the literature (U.S. EPA, 1985, EPA/625/6-85/006; Schleyer, 1987; Nyer, 1992).

5.2.1 Single- and Dual Pump Drawdown

This section describes the equipment configuration and operating characteristics of the single-pump drawdown system used as the basis for comparison of the candidate LNAPL recovery technologies. Figure 5-2 shows a single-pump drawdown system installed in a well. Table 5-5 shows the estimated capital and operating cost for a single-pump drawdown system.

Extraction Wells. The extraction wells are constructed of an unslotted PVC riser connected to slotted PVC well screen positioned to intercept the water table. Well piping of a nominal 6-inch diameter will be used.

Fluid Collection System. In the single-pump drawdown configuration, one pump is positioned in each well so that the suction screen is located just below the required drawdown level. The cost estimate assumes the use of a submersible multistage centrifugal pump powered by an electrical motor. Air-driven and/or positive-displacement pumps might be used, particularly if the required flowrate is low. These equipment options will not alter the system cost. Level detectors connected

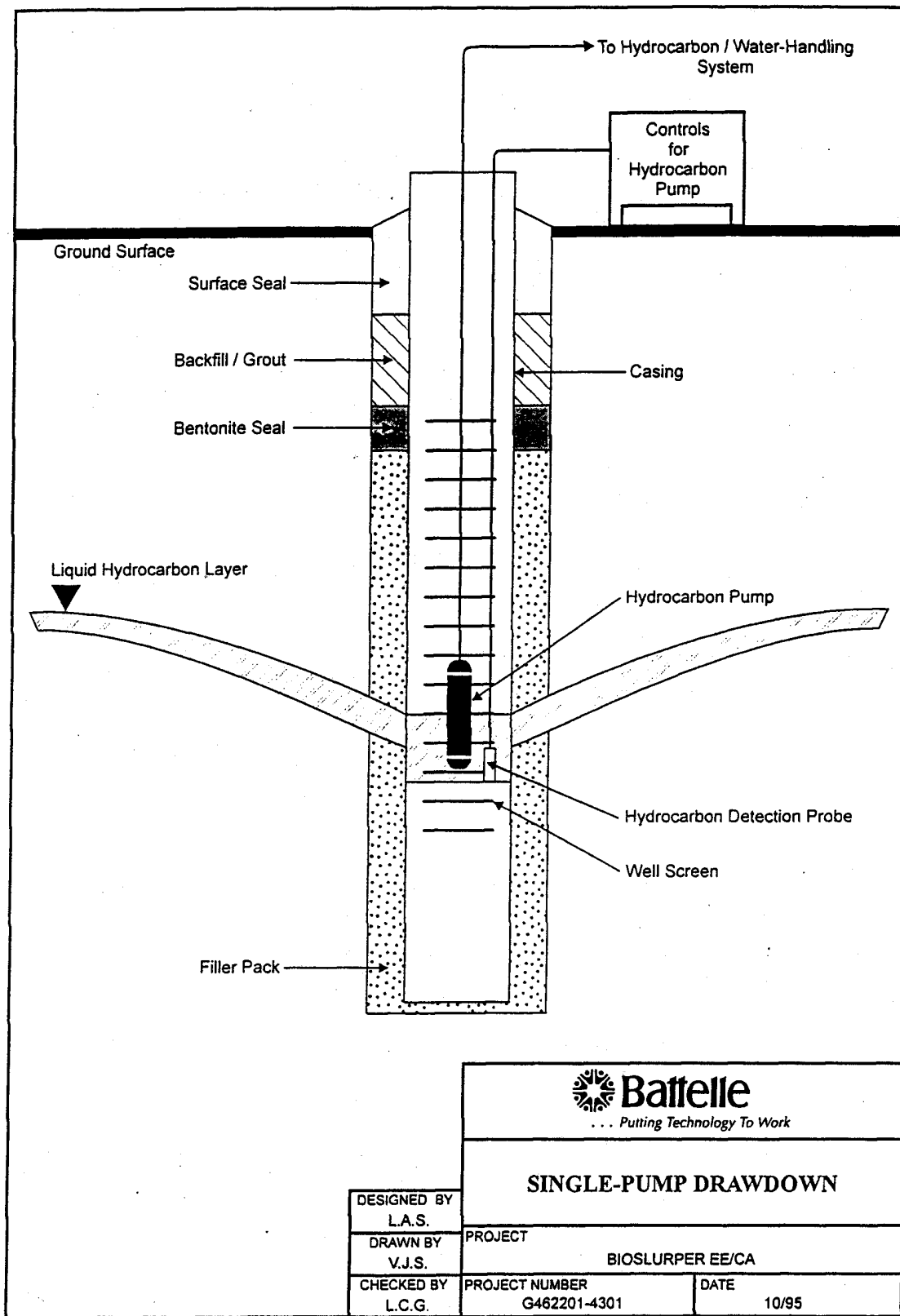

Figure 5-2. Schematic Diagram of a Single-Pump Drawdown System.

Table 5-5. Single-Pump Drawdown System Cost Estimate

Item	Costing Basis	Unit Cost ^(a)	Item Cost
Site Preparation			
Electrical Connection	1,000 feet of buried 4-inch-diameter conduit	\$5.00/ft	\$5,000
Grading and Equipment Platform	1,500 ft ² of subgrade and concrete	\$6.00/ft ²	\$9,000
Well installation	9 wells, 6-inch-diameter PVC casing, 40 feet deep	\$83.20/ft	\$29,950
Equipment (see Figure 5-2)			
LNAPL Recovery Pumps	9 vertical multistage centrifugal pumps, capacity 10 gpm	\$3,000	\$27,000
LNAPL Recovery Pipe and Fittings	1,000 feet of 2- to 4-inch-diameter PVC	\$18.70/ft	\$18,700
Instrumentation	1 group of flow and pressure measurement instruments	\$1,700	\$1,700
Oil/Water Separator	1 coalescing decanter, capacity 15 gpm	\$8,400	\$8,400
LNAPL Holding Tank	1 polyethylene tank, 300 gal	\$550	\$550
LNAPL Transfer Pump	1 centrifugal pump, capacity 5 gpm	\$620	\$620
Water Holding Tank	2 polyethylene tanks, 750 gal each	\$1,100	\$2,200
Water Transfer Pump	1 centrifugal pump, capacity 25 gpm	\$722	\$722
Water Filter	1 bag filter, capacity 25 gpm	\$470	\$470
Mobilization	Movement of personnel and equipment	\$5,000	\$5,000
Engineering	20% of site, equipment, and mobilization costs		\$21,860
Total Capital Cost			\$131,172
Operation and Maintenance		90% uptime, 648 hours per month	Monthly Operating Cost
Electricity	10 kW	\$0.08/kW-hr	\$520
Testing and Monitoring	9 water analyses per month	\$800/sample	\$7,200
Wastewater Disposal	1,640 gal/d	\$3/1,000 gal	\$148
Operating Labor	20 hours per month	\$50/hr	\$1,000
Reporting	1 monthly report and final report (prorated)	\$2,400/month	\$2,400
Total Monthly Operating Cost			\$11,268/month
Total Capital and 6 Months Operating Cost \$198,780			

(a) Unit cost data from Waier (1994), Richardson Engineering Services (1995), and vendor catalogs.

to the pump controller switch the pump off when the water level approaches the suction screen and on when the suction screen is submerged. The pump remains at a fixed depth in the well unless the position is manually adjusted. The pump location in the well must be changed if the water table varies.

Fluid-Handling System. The one pump in the well withdraws a mixture of LNAPL and water that is discharged to an oil/water gravity decanting tank sized for a flow of 15 gpm. The water flows from the bottom of the decanter by gravity to a collection tank. The water is removed from the collection tank with a centrifugal pump, passed through a bag filter, and discharged. The groundwater removal rate used for the base case single-pump drawdown system concept and cost estimate is 1,640 gal/day. Costing is based on the assumption that the LNAPL content of the water is low enough to allow discharge to a sewer or water treatment plant. The assumed cost for disposal of the pumped water is \$3.00/1,000 gal. LNAPL is withdrawn from the decanter and collected. The LNAPL recovery rate used for the base case single-pump drawdown system concept and cost estimate is 4.5 gal/day. Costing is based on the assumption that the LNAPL can be used in a nearby waste-to-energy boiler for a nominal handling charge.

5.2.2 Dual-Pump Drawdown

This section describes the equipment configuration and operating characteristics of the dual-pump drawdown system used as the basis for comparing candidate LNAPL recovery technologies. Figure 5-3 shows a dual-pump drawdown system installed in a well. Table 5-6 shows the estimated capital and operating cost for a dual-pump drawdown system.

Extraction Wells. The extraction wells are constructed of an unslotted PVC riser connected to slotted PVC well screen positioned to intercept the water table. Well piping with a nominal 6-inch diameter will be used.

Fluid Collection System. In the dual-pump drawdown configuration, one pump located deep in the well removes water to produce a cone of depression while the second pump, placed higher in the well, extracts LNAPL. A centrifugal pump is positioned in each well so that the suction screen is located several feet below the required drawdown level. This pump extracts groundwater only. A top entry pneumatic displacement skimming pump is located with its entry port in the LNAPL layer (just above the required drawdown water level). Level detectors located below the upper pump control the lower pump to maintain the water level just below the inlet of the top of the upper pump.

The upper pump collects LNAPL through an entry tube and check valve at the top. As LNAPL rises in the pump body, a float switch triggers application of air pressure to empty the pump body. A lower float switch turns the air pressure off when the LNAPL is displaced from the pump body. The lower pump will withdraw water at an average rate of 1,640 gal/day. The water from the lower pump is collected in a holding tank and periodically is discharged. The upper pump will withdraw LNAPL (possibly containing a small quantity of water) at a rate of 4.5 gal/day.

Fluid-Handling System. The mixture from the upper pump is sent to an oil/water gravity decanting tank sized for a flow of 2 gal/min. Water flows by gravity from the bottom of the decanter to a water collection tank. Water is removed from the collection tank with a centrifugal pump, passed through a bag filter, and discharged. Costing is based on the assumption that the LNAPL content of the water is low enough to allow discharge to a sewer or water treatment plant. The assumed cost for disposal of the groundwater removed from the aquifer by the lower pump and the water from the

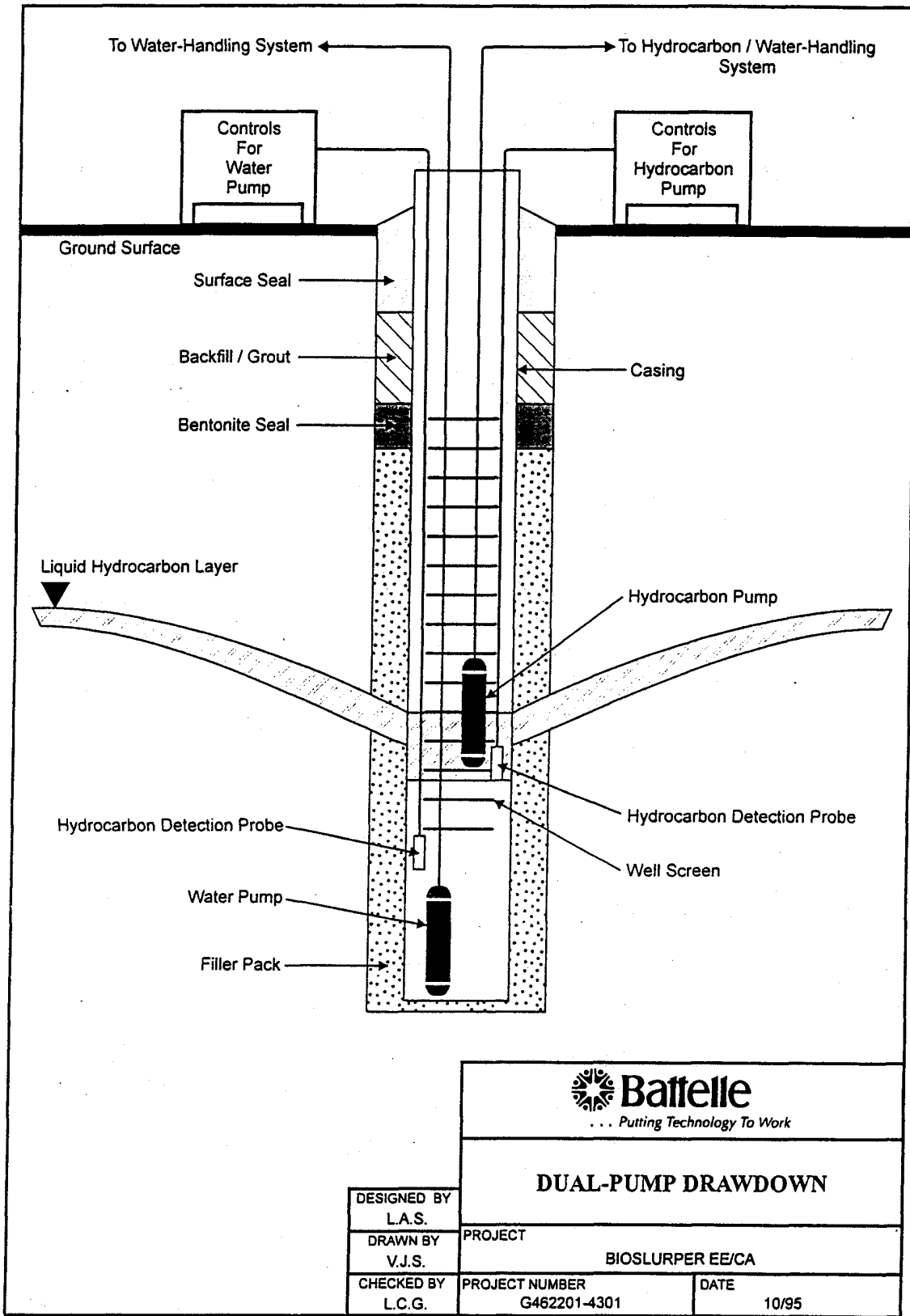

DUAL-PUMP DRAWDOWN

DESIGNED BY L.A.S.	PROJECT BIOSLURPER EE/CA	
DRAWN BY V.J.S.	PROJECT NUMBER G462201-4301	DATE 10/95
CHECKED BY L.C.G.		

EXTRACT2.COR

Figure 5-3. Schematic Diagram of a Dual-Pump Drawdown System.

Table 5-6. Dual Pump Drawdown System Cost Estimate

Item	Costing Basis	Unit Cost ^(a)	Item Cost
Site Preparation			
Electrical Connection	1,000 feet of buried 4-inch-diameter conduit	\$5.00/ft	\$5,000
Grading and Equipment Platform	1,500 ft ² of subgrade and concrete	\$6.00/ft ²	\$9,000
Well Installation	9 wells, 6-inch-diameter PVC casing, 45 feet deep	\$83.20/ft	\$33,700
Equipment (see Figure 5-3)			
LNAPL Recovery Pumps	9 top entry pneumatic pumps, capacity 1 gpm	\$3,000	\$27,000
Air Compressor	20 scfm, 15 HP	\$1,800	\$1,800
Groundwater Removal	9 vertical multistage centrifugal pumps, capacity 10 gpm	\$3,000	\$27,000
LNAPL Recovery Pipe and Fittings	1,000 feet of 1-inch-diameter PVC	\$10.10/ft	\$10,100
Water Removal Pipe and Fittings	1,000 feet of 2-inch-diameter PVC	\$13.90/ft	\$13,900
Instrumentation	1 group of flow and pressure measurement instruments	\$3,000	\$3,000
Oil/Water Separator	1 gravity decanter, capacity 2 gpm	\$1,500	\$1,500
LNAPL Holding Tank	1 polyethylene tank, 300 gal	\$550	\$550
LNAPL Transfer Pump	1 centrifugal pump, capacity 5 gpm	\$620	\$620
Water Holding Tank	2 polyethylene tanks, 750 gal each	\$1,100	\$2,200
Water Transfer Pump	1 centrifugal pump, capacity 25 gpm	\$722	\$722
Water Filter	1 bag filter, capacity 25 gpm	\$470	\$470
Mobilization	Movement of personnel and equipment	\$5,000	\$5,000
Engineering	20 % of site, equipment, and mobilization costs		\$28,312
Total Capital Cost			\$169,874
Operation and Maintenance			Monthly Operating Cost
	90 % uptime, 648 hours per month		
Electricity	20 kW	\$0.08/kW-hr	\$1,040
Testing and Monitoring	9 water analyses per month	\$800/sample	\$7,200
Wastewater Disposal	1,640 gal/d	\$3.00/1,000 gal	\$148
Operation Labor	20 hours per month	\$50.00/hr	\$1,000
Reporting	1 monthly report and final report (prorated)	\$2,400	\$2,400
Total operation Cost			\$11,788/month
Total Capital and 6 Months Operating Cost \$240,602			

(a) Unit cost data from Waier (1994), Richardson Engineering Services (1995), and vendor catalogs

decanter is \$3.00/1,000 gal. LNAPL is withdrawn from the decanter and collected. Costing is based on the assumption that the LNAPL can be used in a nearby waste-to-energy boiler for a nominal handling charge.

5.3 Bioslurping

This section describes the equipment configuration and operating characteristics of the bioslurping system used as the basis for comparison of the candidate LNAPL recovery technologies. Figure 5 shows a bioslurping system installed in a well. Table 5-7 shows the estimated capital and operating cost for a bioslurper system.

5.3.1 Extraction Wells

The extraction wells are constructed of an unslotted PVC riser connected to slotted PVC well screen positioned to intercept the water table. Well piping with a nominal 2-inch diameter will be used.

5.3.2 Fluid Collection System

The vacuum source for the bioslurping system will be a 10-hp water ring vacuum pump. The pump is connected to a manifold leading to dip tubes in each well. The tubes are placed so that the end of the tube is near the water table. The depth to the water table will be monitored several times per week until the water level stabilizes and then periodically thereafter to determine the correct position for the slurping tube. In most cases, the water level should have reached its new equilibrium level within 1 day after the start of bioslurper operation.

5.3.3 Fluid-Handling System

The vacuum in the dip tube causes airflow at sufficient velocity to carry water and LNAPL up the tube in a slug, churn, or annular flow condition. The tube enters a larger-diameter manifold, where the reduced velocity causes a transition to stratified flow conditions. The manifold should be sloped toward the vacuum pump, and low spots and U-traps should be avoided to reduce the tendency for slug flow. A tank should be provided just before the vacuum pump to prevent fast-moving slugs of water from entering the vacuum pump. Within this system, most of the entrained liquid is captured and retained by the fluid ring seal in the pump. Off-gas exits the pump to a baffled settling chamber/level maintenance tank to further reduce the concentration of entrained droplets in the off-gas. Overflow from the pump body and liquid collected by the settling chamber enters a level-maintenance tank. The level-maintenance tank is an integral part of the water ring pump. This tank holds an inventory of fluid to ensure that the water ring pump has the required level of working fluid. Excess LNAPL and water collected by the vacuum pump flows from the level-maintenance tank and enters an oil/water gravity decanting tank sized for a flow of 50 gal/min. A high-capacity coalescing decanter is assumed for costing to allow for additional time to break emulsions formed in the vacuum pump. Water flows by gravity from the oil/water separator into the collection tank. Water is withdrawn from the bottom of the collection tank with a centrifugal pump, filtered, and discharged. The groundwater removal rate used for the base case bioslurping system concept and cost estimate is 1,800 gal/day. Costing is based on the assumption that the LNAPL content of the water is low enough to allow it to be discharged to a sewer or water treatment plant. The assumed cost for disposal of the pumped water is \$3.00/1,000 gal. LNAPL is withdrawn from the decanter and collected. The LNAPL recovery rate used for the base case bioslurping system concept and cost

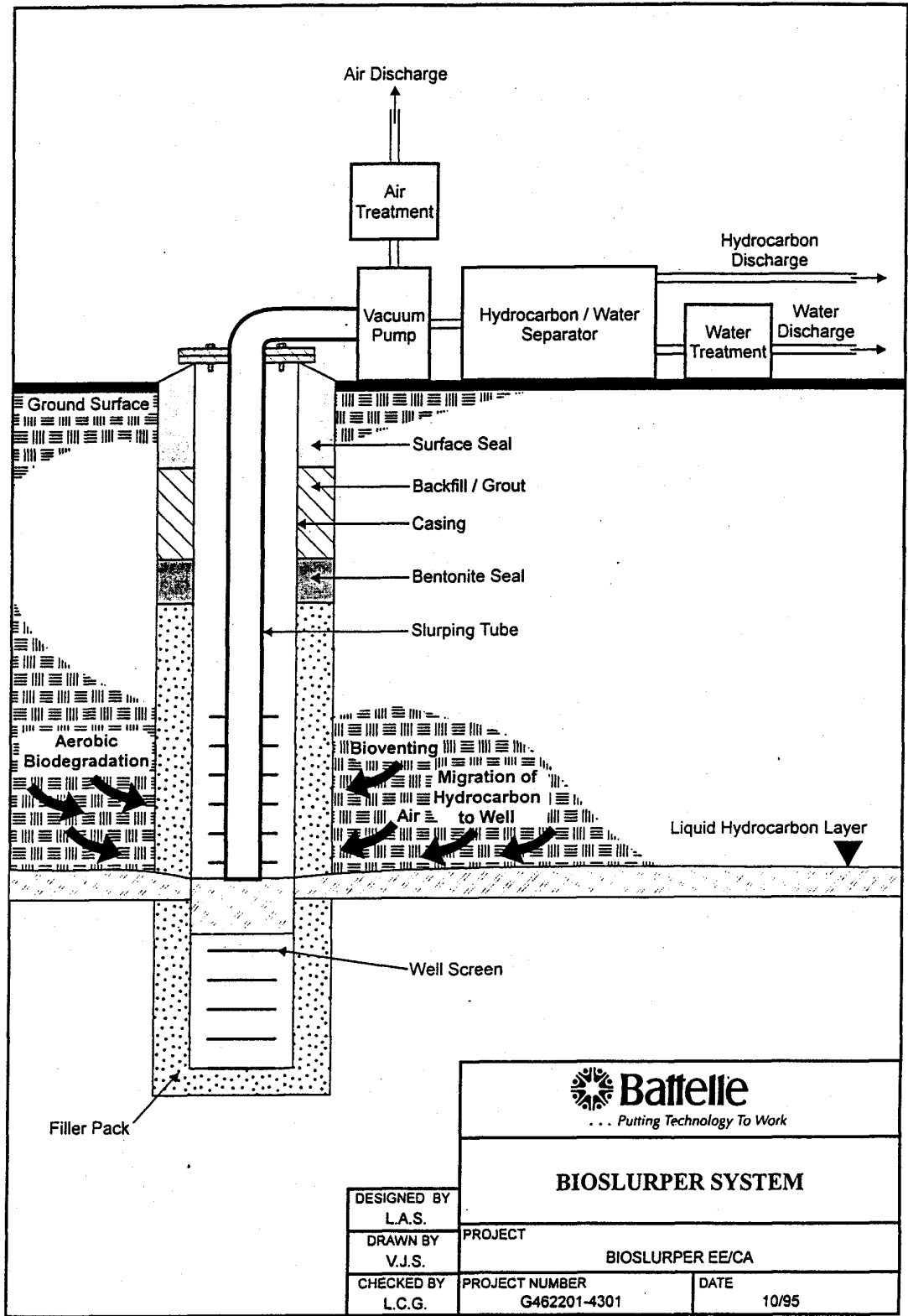

Figure 5-4. Schematic Diagram of a Bioslurper System.



BIOSLURPER SYSTEM

DESIGNED BY L.A.S.	PROJECT BIOSLURPER EE/CA	
DRAWN BY V.J.S.	PROJECT NUMBER G462201-4301	DATE 10/95
CHECKED BY L.C.G.		

Table 5-7. Bioslurper System Cost Estimate

Item	Costing Basis	Unit Cost ^(a)	Item Cost
Site Preparation			
Electrical Connection	1,000 feet of buried 4-inch-diameter conduit	\$5.00/ft	\$5,000
Grading and Equipment Platform	1,500 ft ² of subgrade and concrete	\$6.00/ft ²	\$9,000
Well Installation	9 wells, 2-inch-diameter PVC casing, 45 feet deep	\$67.05/ft	\$18,100
Equipment (see Figure 5-4)			
Vacuum Pump	1 water ring vacuum pump, 10 hp	\$11,000	\$1100
Slurping Tube and Piping	1,000 feet of ½- to 2-inch diameter poly and PVC	\$10.10/ft	\$10,100
Off-Gas Pipe and Fittings	50 feet of 4-inch diameter PVC	\$18.70/ft	\$935
Water Transfer Pipe and Fittings	1,00 feet of 2inch-diameter PVC	\$10.10/ft	\$10,100
Water Removal Pipe and Fittings	1,000 feet of 2-inch-diameter PVC	\$13.90/ft	\$1,390
Instrumentation	1 group of flow and pressure measurement instruments	\$2,000	\$2,000
Oil/Water Separator	1 gravity decanter, capacity 50 gpm	\$10,000	\$10,000
LNAPL Holding Tank	1 polyethylene tank, 300 gal	\$550	\$550
LNAPL Transfer Pump	1 centrifugal pump, capacity 5 gpm	\$620	\$620
Water Holding Tank	2 polyethylene tanks, 750 gal each	\$1,100	\$2,200
Water Transfer Pump	1 centrifugal pump, capacity 25 gpm	\$722	\$722
Water Filter	1 bag filter, capacity 25 gpm	\$470	\$470
Mobilization	Movement of personnel and equipment	\$5,000	\$5,000
Engineering	20 % of site, equipment, and mobilization costs		\$15,420
Total Capital Cost			\$92,507
Operation and Maintenance			Monthly Operating Cost
	90 % uptime, 648 hours per month		
Electricity	20 kW	\$0.08/kW-hr	\$780
Testing and Monitoring	9 water analyses per month	\$800/sample	\$8,000
Wastewater Disposal	1,640 gal/d	\$3.00/1,000 gal	\$162
Operation Labor	20 hours per month	\$50.00/hr	\$1,000
Reporting	1 monthly report and final report (prorated)	\$2,400	\$2,400
Total operation Cost			\$12,342/month
Total Capital and 6 Months Operating Cost \$166,559			

Unit cost data from Waier (1994), Richardson Engineering Services (1995), and vendor catalogs

estimate is 21 gal/day. Costing is based on the assumption that the LNAPL can be used in a nearby waste-to-energy boiler for a nominal handling charge.

5.3.4 Emulsion Treatment Options

Turbulence generated by the extraction process and in the water ring vacuum pump mixes LNAPL and water. In some cases, an emulsion of LNAPL can form that is stable enough to prevent successful separation in the oil/water decanting vessel. If the decanting separation is inefficient, the LNAPL content of the water will be too high to allow disposal to a sewer or the POTW. Formation of the emulsion can be reduced by preventing the LNAPL and groundwater mixture from entering the water ring pump. The LNAPL and groundwater can be intercepted by placing a vapor/liquid separator ahead of the vacuum pump. However, field experience has shown that significant emulsion control can be accomplished by allowing the mixture increased residence time in a filter tank prior to entering the oil/water separator. The filter tank is a long, rectangular tank containing fibrous filter batts (see Figure 5-5). The filter tank approach is considered more effective and reliable than placing a vapor/liquid separator ahead of the vacuum pump because much of the emulsion formation occurs in the bioslurping dip tube prior to entering the vacuum pump. If no wastewater treatment plant is available, or the wastewater treatment plant can accept only low concentrations of oil and grease, additional processing will be needed. A settling tank with sufficient volume to accept 1 day's water production allows additional coalescing time to improve oil removal. In demanding situations, a dissolved air flotation system will be needed.

5.3.5 Off-Gas Treatment Options

As part of preparing a handbook describing SVE applications, the U.S. EPA conducted a state-by-state telephone survey in July and August, 1989 (U.S. EPA, 1991, EPA/540/2-91/003). Nearly half (24 of 51) of the states had no statewide air discharge standards and relied on federal standards. Many of the general emission source laws were written primarily for large sources such as power plants. Bioslurping systems (which are by comparison small sources) may not require off-gas treatment if only small quantities of volatile organic compounds (VOCs) are emitted.

Nine states had not established specific discharge regulations but did require permits for small point source treatment systems. Of these nine, two states, Kansas and Oregon required permits only for sites that discharged more than 10 tons of VOCs per year.

Seventeen states had discharge limits expressed on a mass per time basis, but the allowable limits varied widely from state to state. For example, North Carolina allowed up to 40 lb per day, whereas the District of Columbia allowed only 1 lb per day to be discharged. Other states had compound-specific emission limits. Connecticut, for example, listed more than 100 compounds with allowable limits based on both an 8-hour average and a 30-minute average. Some states (e.g., Vermont) required that the vapor concentration in the influent stream be reduced by up to 85 %.

In summary, the states vary widely in their air emission regulations in the 1989 survey, from little or no formal regulation of releases to detailed regulation of specific chemical contaminant releases. Some states based their standards on the concentration at the nearest receptor, whereas others treated each site on a case-by-case basis. The details of VOC discharge regulation will have changed since 1989, but the general trends of local control of air discharge permitting and widely varying regulatory approaches and discharge limits are still valid.

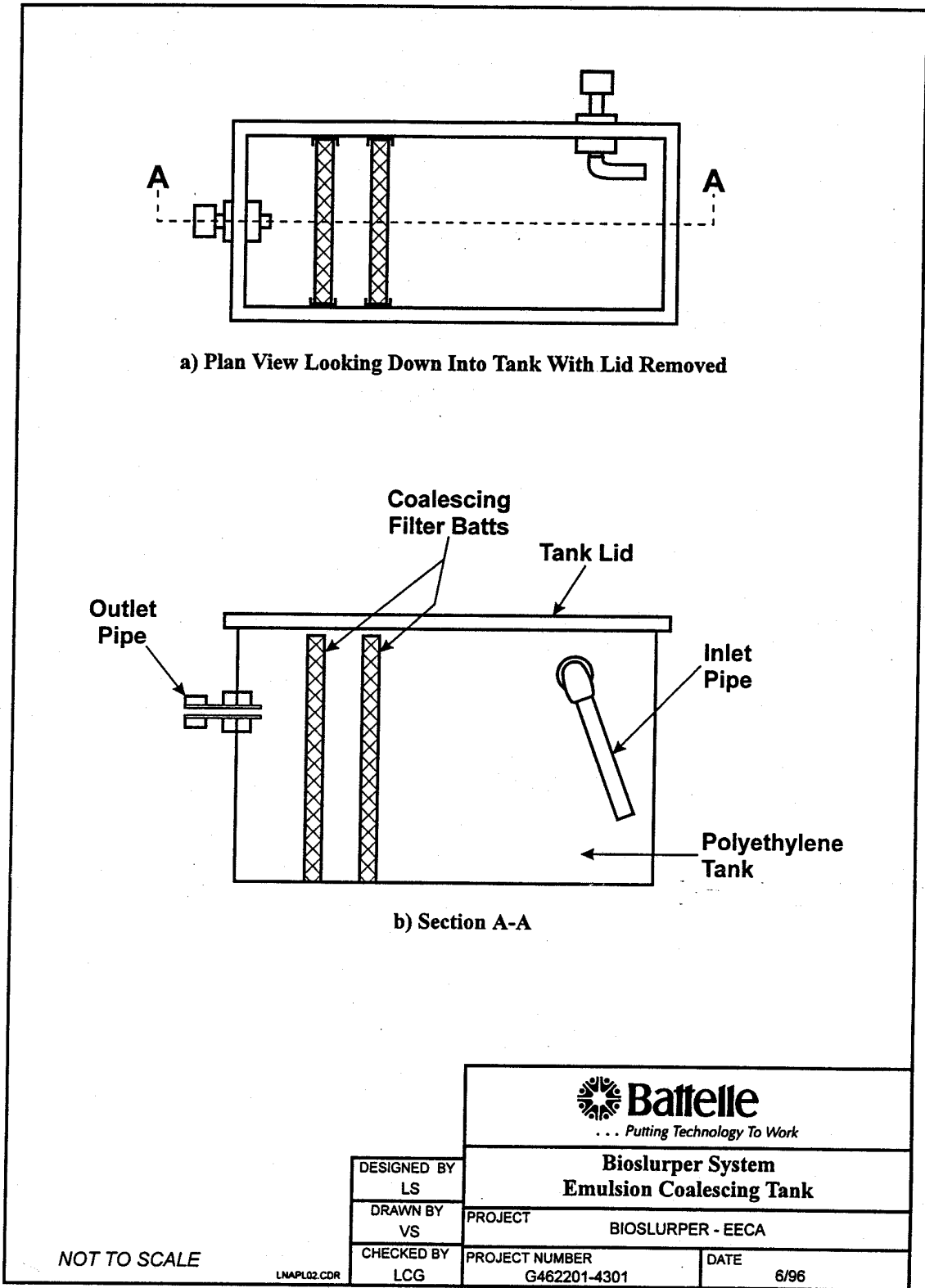

Figure 5-5. Bioslurper System Filter Tank.

If the contaminant concentrations in the vapor are low but treatment is required, adsorption on granular activated carbon (GAC) is an option. However, the treatment costs increase rapidly with increasing vapor concentrations.

For intermediate vapor contaminant concentrations, vapor reinjection is a treatment option for off-gas from the bioslurper system. Vapor reinjection is the favored off-gas treatment approach when biological activity and soil permeability are high enough and the location of subsurface structures does not present a problem.

If vapor reinjection is not feasible due to high contaminant concentration or poor soil conditions, other options are available for off-gas treatment. Incineration or thermal destruction in an internal combustion engine (ICE) are commercially available treatment options.

Each of these treatment options is described in more detail below. Additional descriptions and cost and performance data on off-gas treatment were reported by Vataavuk (1990) and Mukhopadhyay and Moretti (1993). The estimated capital and operating costs for catalytic incineration and ICE off-gas treatment options are tabulated for an off-gas flow rate of 65 scfm. The costs are a function of the organic vapor concentration of the off-gas being treated. Costs are given for three different vapor cases: (1) nearly clean air, (2) a vapor concentration at one quarter of the lower explosive limit for gasoline (3,500 ppmv), and (3) a vapor concentration at the lower explosive limit for gasoline (14,000 ppmv).

Bioslurper off-gas treatment in a biological filter is also an option. A biological filter was used to treat both off-gas and water for a pilot bioslurper system (Connolly et al., 1995). A variety of tests of biofilters have been reported in the literature indicating effective treatment of influent vapor concentrations in the range of 50 to 5,000 ppmv (U.S. EPA, 1994, EPA/542-R-94-003). For a vapor concentration of 1,000 ppmv the reported residence time required for treatment is 15 to 90 seconds (Skladany et al., 1994). Use of biofiltration is an innovative technology. The data available were insufficient to allow a detailed cost or performance comparison with the more conventional off-gas treatment technologies.

Vapor Reinjection. In situ bioremediation of the bioslurping vapor emissions can be a cost-effective and environmentally sound treatment option. Off-gas reinjection configurations can offer the advantages of low surface emissions and no point source generation. The reinjection treatment option consists of distributing extracted air with contaminant vapors back into the soil to allow in situ aerobic biodegradation to destroy the contaminants. Reinjection is accomplished by piping the discharge of the vacuum pump to air distribution wells or trenches where the air infiltrates back into the soil. In situ respiration and soil gas permeability data must be available for the site. These data indicate the expected biodegradation rate and radius of influence that are required to determine the design capacity for the reinjection point. The soil volume available must be sufficient to accept the off-gas airflow and allow biodegradation of the contaminant mass flow in the off-gas.

Reinjection wells should be located and designed to ensure that the reinjection process is destroying the contaminants rather than increasing contaminant migration. After reinjection is established, surface emission testing must be performed to ensure that contaminants are not escaping at the site surface. Soil gas monitoring should be performed to ensure that contaminant migration is not being increased. Monitoring of migration is particularly important at sites where air extraction is necessary due to the presence of buildings. Estimated costs for vapor reinjection to treat off-gas are given in Table 5-8.

Table 5-8. Estimated Costs for Off-Gas Treatment by ReInjection^(a)

Cost Item	Cost with Inlet Concentration of 1 ppmv	Cost with Inlet Concentration of 3,500 ppmv	Cost with Inlet Concentration of 14,000 ppmv
Injection well installation cost (\$)	\$19,000	\$27,000	Not applicable
Monthly operating cost (\$/month)	\$230	\$230	Not applicable
Total cost for 6-month operation (\$)	\$20,380	\$28,380	Not applicable

(a) Off-gas flow of 65 scfm.

Adsorption. Adsorption refers to the process by which molecules collect on and adhere to the surface of an adsorbent solid (U.S. EPA, 1988, EPA/530/UST-88/001). This adsorption is due to chemical and/or physical forces. Physical adsorption (the more common type in this application) is due to van der Waals forces, which are common to all matter and result from the motion of electrons. Surface area is the critical factor in the adsorption process, because the adsorption capacity is proportional to the surface area. Commercially available adsorbents include activated carbon and synthetic resins.

Granular activated carbon (GAC) is the most commonly used vapor-phase treatment method. Activated carbon adsorbents provide a high surface area in a low-unit-cost material due to the carbon's complex internal pore structure. Commercially available GAC typically has a surface area of 1,000 to 1,400 m²/gram.

GAC is a cost-effective organic vapor treatment method for a wide range of applications due to its relative ease of implementation and operation, its established performance history in commercial applications, and its applicability to a wide range of contaminants at a wide range of flowrates. Many vendors sell or lease prefabricated, skid-mounted units that can be put into operation with a few days notice. However, carbon adsorption is economical only for lower mass removal rates. When the vapor concentration is high, carbon replacement requirements may be prohibitively expensive.

The adsorption capacity of the carbon depends on several factors, including influent vapor temperature and relative humidity and, most importantly, the influent VOC types and concentrations. Isotherms, which show the mass of contaminants that can be adsorbed per unit mass of carbon, are available to predict the contaminant-specific adsorption capacity for a specific type of carbon. GAC generally has a high affinity for volatile organic molecules, such as hydrocarbons or chlorinated compounds. These volatile organics are the types of compounds typically removed by airflow through organic-contaminated soil; however, some hydrocarbons such as isopentane are adsorbed poorly.

Although GAC has a very high surface area for adsorption of contaminants, the mass of contaminants removed may exceed the carbon's capacity. At sites requiring high organic contaminant mass removal rates due to high concentration, high flowrate, or both, the adsorption capacity of the carbon may be quickly exhausted. Replacement and disposal of spent carbon can become expensive. The cost of disposal of spent carbon will be particularly high if hazardous solvents sorbed on the spent carbon result in the entire spent carbon volume being identified as a RCRA-listed or RCRA-characteristic waste.

High relative humidity in the incoming vapor stream limits the effectiveness of and increases the cost of vapor treatment with GAC. Water vapor preferentially occupies adsorption sites, thereby decreasing the capacity of the carbon to remove contaminants from the air stream. Entrained water should be removed from the incoming vapor stream by an air/water separator. Vendors typically recommend that the relative humidity of the off-gas stream should be below 50% prior to entering the GAC adsorber. Reduction of relative humidity usually is achieved by prewarming the air. However, preheating to reduce the effect of water vapor also reduces the effective capacity of the carbon, so a trade-off is involved in selecting the preheat temperature.

As a rule of thumb, the adsorptive capacity of activated carbon for most hydrocarbons in the vapor stream is about 1 lb hydrocarbon: 10 lb activated carbon. The cost of activated carbon is about \$3/lb (all costs included, not just carbon purchase), so the cost of activated carbon treatment can be estimated roughly as being about \$30/lb of hydrocarbon to be treated. Estimated costs for vapor treatment with GAC are given in Table 5-9.

Table 5-9. Estimated Costs for Off-Gas Treatment with Granular Activated Carbon

Cost Item	Cost with Inlet Concentration of 1 ppmv	Cost with Inlet Concentration of 3,500 ppmv	Cost with Inlet Concentration of 14,000 ppmv
Capital cost (\$)	0.00	0.00	Not Applicable
Monthly operating cost (\$/month)	\$32.30	\$113,000.00	Not Applicable
Total cost for 6-month operation	\$193.80	\$678,000.00	Not Applicable

(a) Off-gas flow of 6s scfm.

Specialized resin adsorbents have been developed and are now entering commercial application for treatment of organic vapors in off-gas streams. These synthetic resin adsorbents have a high tolerance to water vapor. Air streams with relative humidities greater than 90% can be processed with little reduction on the adsorption efficiency for organic contaminants. The resin adsorbents are amenable to regeneration on site. Skid-mounted modules are available consisting of two resin adsorbent beds. The design allows one bed to be on line treating off-gas while the other bed is being regenerated. During the desorption cycle, all of the organic contaminants trapped on the resin are removed, condensed, and transferred to a storage tank. The desorption process used to regenerate the resin is carried out under vacuum using a minimum volume of nitrogen purge gas. A heat exchanger in the bed heats the resin during regeneration. The same heat exchanger is used to cool the bed to increase sorption capacity while it is on line treating off-gas (Downey et al., 1994).

Catalytic Incineration. Catalytic incineration is a thermal treatment process that uses a catalyst to increase the oxidation rate of organic contaminants in an off-gas stream, allowing acceptable destruction efficiency at a lower temperature than flame incineration. In catalytic incineration, the off-gas is heated and passed through a combustion unit where the gas stream contacts the catalyst. The catalyst accelerates the chemical reaction without undergoing a chemical change itself. The catalyst increases the oxidation reaction rate by adsorbing the contaminant molecules on the catalyst surface. Sorption phenomena on the catalyst serve to increase the local concentration of organic

contaminants at the catalyst surface and, for some organic contaminants, reduce the activation energy of the oxidation reaction. Increased concentration and reduced activation energy increase the rate of oxidation of the organics (Kiang, 1988).

The active catalytic material typically is a precious metal (e.g., palladium or platinum) that provides the surface conditions needed to facilitate the transformation of the contaminant molecules into carbon dioxide and water. The catalyst metal is supported on a lower cost, high-surface-area metallic or ceramic support medium.

The metal catalyst and support are exposed to the heated off-gas in a catalytic incineration unit. The catalytic incineration unit uses either a fixed-bed or a fluidized-bed system. Fixed-bed systems include metallic mesh, wire, or ribbon or ceramic honeycomb supporting the catalyst metal or a packed bed of catalyst-impregnated pellets. Fluidized beds also use catalyst-impregnated ceramic pellets but operate at sufficiently high flow to move and mix the pellets during treatment (Kiang, 1988).

The main advantage of catalytic incineration versus flame incineration is the much lower temperature required with a catalyst. These systems typically operate at 600 to 900°F (CSM Systems, 1989), versus temperatures of 1,200 to 1,600°F for flame incineration. The lower temperature results in lower fuel costs, less severe service conditions for the incinerator construction materials, and reduced NOX production. Natural gas or propane is a typical fuel used for supplemental heating when the contaminated vapor streams do not contain sufficient heat value for a self-sustaining incineration. Energy costs can be further reduced by reclaiming heat from the exhaust gases, i.e., using the exhaust gas flow to preheat the influent vapor stream.

Catalytic incineration units require careful monitoring to prevent overheating of the catalyst. Overheating can damage the catalyst metal surface and/or the support, reducing catalytic activity. The allowed influent organic vapor concentration depends on the heat value and lower explosive limit (LEL) of the influent vapor stream. Concentrations over about 3,500 ppm VOCs normally are diluted with air to prevent excessive energy release rates and to control the temperature in the catalytic unit. Safety is a concern with these units, as with any incineration method. The maximum permissible total hydrocarbon concentration depends on the local fire codes and permitting requirements but is below 25% of the LEL at essentially all sites. The total hydrocarbon concentration in the vapor is continuously measured at the inlet to the catalytic unit to control the dilution airflow during operation.

Treating off-gas containing halogenated compounds, sulfur-containing compounds, or nitrogen containing compounds will deactivate a conventional catalyst due to chemical reaction of the catalyst metal with halogens or strong sorption of SO_x and NO_x on the catalyst. Catalysts specially designed for treatment of chlorinated compounds by catalytic incineration are available on the market but are more expensive than catalysts for treating petroleum hydrocarbons. The incineration unit typically will require scrubbing to remove acid gases formed when treating halogenated compounds (Buck and Hauck, 1992).

The significant cost elements of a catalytic incinerator are the capital cost (or rental) of the unit, operations and monitoring, maintenance, and makeup fuel cost. Estimated costs for off-gas treatment using catalytic incineration without heat recovery are given in Table 5-10. Installed system cost and fuel use are based on manufacturer's data.

Flame Incineration. Flame incineration converts hydrocarbon compounds to carbon dioxide and water by direct thermal oxidation. Complete destruction of contaminants requires high temperatures,

Table 5-10. Estimated Costs for Off-Gas Treatment with Catalytic Incineration^(a)

Cost Item	Cost with Inlet Concentration of 1 ppmv	Cost with Inlet Concentration of 3,500 ppmv	Cost with Inlet Concentration of 14,000 ppmv
Capital cost (\$)	\$40,000	\$40,000	\$45,000 ^(b)
Monthly operating cost (\$/month)	\$640	\$640	\$1,500
Total cost for 6-month operation (\$)	\$43,840	\$43,840	\$54,000

(a) Off-gas flow of 65 scfm.

(b) Airflow 260 scfm to dilute combustible content to 25 % of LEL.

typically 1,200 to 1,600°F, and/or long residence times. In a thermal incineration system the off-gas is mixed and introduced into a refractory-lined combustion chamber where one or more burners supply heat to thermally oxidize organic contaminants. When the influent vapor concentration is low, addition of makeup fuel will be needed to maintain the temperature required to ensure adequate mineralization. Natural gas or propane typically serves as the supplemental fuel. When the influent vapor concentration is high, dilution air may be needed. For safety reasons, influent concentrations normally are limited to 25% of the LEL (U.S. EPA, 1986, EPA/625/6-86/014). The LEL for gasoline is between 12,000 ppmv and 15,000 ppmv, depending on the gasoline's grade (Little, 1987).

Direct incineration is usually inappropriate for influent vapor streams containing chlorinated compounds. Complete combustion of these compounds will generate corrosive hydrochloric acid vapors. Partial or incomplete combustion of chlorinated compounds could result in the production of chlorinated products of incomplete combustion.

The capital cost of a flame incinerator typically is less than that of a catalytic incinerator, and at higher hydrocarbon concentrations may be less costly than catalytic incineration. The flame incinerator operates at a higher temperature than a catalytic incinerator. The supplemental fuel cost for the flame incinerator increases more rapidly than the fuel cost for the other incineration methods when the vapor concentration decreases. Thermal incineration becomes cost competitive when the inlet vapor concentration approaches 25 % of the LEL.

Flameless Incineration. The flameless incineration process converts hydrocarbon compounds to carbon dioxide and water by passing an off-gas stream through a heated ceramic matrix. The matrix geometry and uniform high temperature of the matrix are reported to give good destruction efficiency for organic vapors in air, without using an open flame. The vendor indicates that this technology has several desirable characteristics for treatment of vapors in off-gas from remediation systems. The removal efficiency is reported to be high and stable over varying operating conditions. Tests have shown efficiencies of 99.99+ %, and this removal is attained continuously (Rubin, 1995).

Initially the matrix is raised to the operating temperature of 1800°F by electrically powered radiant heating. No additional energy input is required if the heat value of the vapors is sufficient. This point is near a concentration of 200 ppmv. If the concentration is below this value, natural gas or propane can be bled in with influent to maintain the proper temperature.

As with any incineration technique, excess air is added to dilute the concentration to safe levels if the influent is too rich. Incineration in a ceramic bed has handled influent vapor concentrations at the percent level. Throughput levels depend on the model selected (presently ranging from 100 to 1,500 scfm) with higher flowrates met by combining two or more of the modular units.

Flameless incineration units have higher capital cost than flame incineration or catalytic incineration units but have much lower energy use. The flameless units are most cost-competitive when the off-gas flowrate is high and the contaminant concentration is low. According to the vendor, the greatest advantage of this technique is its ability to mineralize chlorinated compounds without producing chlorinated products of incomplete combustion or degrading the ceramic beads. Mineral acid vapors would still be produced.

Internal Combustion Engine Treatment. Internal combustion engine treatment accomplishes destruction of organic contaminants by oxidation in a conventional engine. Internal combustion engines (ICEs) have been used for years to destroy landfill gas. Application of ICEs to destruction of hydrocarbon vapors in air streams is more recent. The first operational unit was installed in 1986.

The ICE used for this technique is an ordinary industrial or automotive engine with its carburetor modified to accept vapors rather than liquid fuel. The airflow capacity of the ICE is determined by the cubic inch displacement of the engine, the engine speed, and the engine vacuum. The capacity can be estimated as:

$$\text{capacity} = (\text{RPM}/2) * (\text{CID}/1,728) * (0.85) * [1 - (\text{EV}/\text{P})]$$

where: RPM = engine speed in revolutions per minute
CID = engine displacement in cubic inches
EV = vacuum in the engine intake manifold in inches of mercury
P = local air pressure in inches of mercury

A 140-in³-displacement 4-cylinder engine running at 2,250 rpm and 10-in Hg engine vacuum with an atmospheric pressure of 30-in Hg would have an off-gas treatment capacity of 52 scfm. ICE treatment units are available in sizes from 140 in³ to 920 in³. Currently available ICE treatment units operate the engine near idle conditions. The off-gas capacity could be increased by applying a load to the engine to increase engine speed and decrease engine vacuum (increase absolute pressure in the manifold). Engine loading by attaching a generator to supply power to the site has been proposed but is not routinely practiced.

A second required modification to the engines is the addition of a supplemental fuel input valve when the intake hydrocarbon concentration is too low to sustain engine operation. Propane is used almost universally, although one vendor reported that natural gas, when available, can reduce energy cost by 50 to 75 % relative to propane.

The engines also are equipped with a valve to bleed in ambient air to maintain the required oxygen concentration. Soil vapor may have very low concentrations of oxygen, especially during the initial stages of operation. Ambient air is added to the engine, via an intake valve, at a ratio sufficient to bring the oxygen content up to the stoichiometric requirement for combustion.

A catalytic converter is an integral component of the system, providing an important polishing step to reach the low discharge levels required by many regulatory agencies. A standard automobile catalytic

converter, using a platinum-based catalyst, normally is used. Data from the South Coast Air Quality Management District (SCAQMD), the air quality regulatory body for Los Angeles and the surrounding area, show that the catalyst reduced concentrations of TPH from 478 ppm to 89 ppm and from 1,250 ppm to 39 ppm, resulting in important additional contaminant removal (U.S. EPA, 1991, EPA/540/2-91/003). The SCAQMD, which has among the most stringent air discharge regulations in the country, requires a catalytic converter to permit this type of system. To date, ICE use appears to be most widespread in California, mostly in the SCAQMD which has permitted more than 100 ICEs for use in their district.

Catalysts have a finite life span (typically expressed in hours of operation) and must be monitored as that time approaches to ensure that they are working properly. The length of operation of the catalyst depends on the vapor concentration and whether lead or other potential catalyst poisons are present in the off-gas contaminants. A range suggested by one equipment vendor was 750 hours to 1,500 hours (about 1 to 2 months) of operation. A deactivated catalyst can be replaced easily with any automobile catalytic converter, available at most auto parts stores.

Data obtained from ICE operators and regulators show that ICEs are capable of destruction efficiencies of well over 99% (U.S. EPA, 1991, EPA/540/2-91/003, p. 93). ICEs are especially useful for treating vapor streams with high concentrations of TPH (up to 30% volume) to levels below 50 ppm. Tests of destruction of BTEX by ICE treatment show that nondetectable levels of contaminants can be achieved in the outlet off-gas in some cases and outlet concentrations below 1 ppm can be achieved in many cases. The total destruction capacity may be expressed as mass removal rate. One ICE operator reported a mass removal and destruction rate of over 1 ton per day (about 12 gallons per hour).

ICE off-gas treatment units are able to handle high concentrations of organic contaminants in the extracted air. As discussed above, catalytic oxidation units usually are limited to inlet vapor concentrations of 25 % of the LEL, whereas the inlet concentration for an ICE unit can be up to the LEL. As a result, the ICE treatment units have a significant advantage over incineration units when the vapor concentration is higher than 25 % of the LEL. Reports of inlet vapor concentration have gone as high as 300,000 ppm (U.S. EPA, 1991, EPA/540/2-91/003). The off-gas must still be diluted with air to allow the ICE unit to treat off-gas containing more than about 16,000 ppmv of organics, but only one quarter as much dilution airflow is needed for the ICE unit compared to an incineration unit.

ICEs also can effectively treat low concentrations (i.e. inlet vapor concentration below 1,000 ppm), although supplemental fuel use increases as the inlet concentration drops below 14,000 ppmv and the cost effectiveness decreases at reduced intake concentrations. The removal efficiency compares favorably with other treatment methods, based on data available from actual system installations.

ICEs as vapor treatment devices for extracted soil vapors offer advantages over conventional treatment methods (carbon adsorption, flame incineration, or catalytic incineration), at least for some applications. One advantage of ICEs is the ability to produce power that can provide useful work output. Self-contained units are available that use power takeoff from the ICE drive shaft to drive a blower or an electrical generator.

The ICE theoretically could be used to provide the vacuum for a bioslurping system. Using the engine as a vacuum source increases the engine vacuum, which has the undesirable effect of reducing

the airflow capacity (see equation above). As a result, the ICE usually is coupled to a blower or vacuum pump to supply the wellhead vacuum, or to a generator to supply electricity.

Another advantage of ICEs is their portability. Typically, the self-contained units are skid-mounted or put on a trailer and can go from site to site very easily. The site requirements also may favor ICEs over other oxidation methods. ICE units reportedly are smaller and less noticeable than direct thermal incineration units and may be more appropriate for areas that are intended to remain low profile.

Some disadvantages of ICEs have been noted. The primary drawback may be that the method requires a fairly high degree of manual supervision, especially when the system is being started up. Mainly, the air-to-fuel ratio must be adjusted to maintain the proper conditions for complete combustion. Microcomputers are available to monitor and adjust the air-to-fuel ratio and add propane as needed; however, immediately after system startup, the characteristics of the extracted vapors may change so quickly that manual adjustment is required. As the system operates for a longer period, manual attendance may no longer be required. The mechanical complexity of the ICE is also a disadvantage. Over long-term operation, the maintenance costs for an ICE can be higher than for catalytic oxidation or flame incineration. Noise associated with the operation of the engine could be a concern in areas near residential zones or occupied buildings. Noise can be abated by adjusting the engine speed during certain time periods, installing a noise suppression fence, or purchasing special low-noise ICE models (AFCEE, 1994).

The capital cost of currently available ICE units appears to be somewhat higher, but certainly is in the same general range as for catalytic incineration and flame incineration. The capacities and costs of three ICE treatment units are summarized in Table 5-11. Propane or natural gas fuel is needed when the inlet vapor concentration is below about 14,000 ppmv. The quantity of added fuel required increases as the inlet vapor concentration declines.

Table 5-11. Capacities and Costs of Internal Combustion Engines for Off-Gas Treatment

Unit Size (cubic-inch displacement)	Number of Capacity Cylinders	Maximum Capacity (scfm)	Approximate Cost (1996 \$\$)
140	4	65	\$34,000
300	6	140	\$40,000
460	8	210	\$60,000
920	2x8	430	\$81 000

Operations and maintenance costs are site specific for off-gas treatment by ICE. In general they appear to be somewhat higher than for other thermal processes, but generally in the same range as catalytic incineration and flame incineration. As ICEs use a much more widely understood technology, gaining regulatory acceptance appears to be easier than for other technologies, and as a result, permitting and monitoring costs should be lower. Estimated costs for off-gas treatment with an ICE are given in Table 5-12.

Table 5-12. Estimated Costs for Off-Gas Treatment in an Internal Combustion Engine^(a)

Cost Item	Cost with Inlet Concentration of 1 ppmv	Cost with Inlet Concentration of 3,500 ppmv	Cost with Inlet Concentration of 14,000 ppmv
Capital cost (\$)	\$40,000	\$40,000	\$40,000
Monthly operating cost (\$/month)	\$2,200	\$1,750	\$260
Total cost for 6-month operation (\$)	\$53,200	\$50,500	\$41,560

(a) Off-gas flow of 65 scfm.

6.0 LNAPL RECOVERY TECHNOLOGY EVALUATION PROCESS

This section compares the performance of bioslurping with skimming and drawdown pumping in the areas of effectiveness, implementability, and cost. To be effective the technology must protect human health and the environment and comply with ARARs. Compliance with these threshold criteria is measured against site-specific cleanup goals and ARAR-derived constraints.

The long-term effectiveness criterion refers to the ability of an alternative to maintain reliable protection of human health and the environment over time once the cleanup levels have been met. Long-term effectiveness considers the risk posed by treatment residuals and untreated wastes. Reduction of the toxicity, reduction of mobility, and reduction of the volume of contaminants are the three principal measures of the overall performance of a remediation project. The 1986 amendments to the Superfund statute emphasize that, whenever possible, the preferred alternative is one that permanently reduces (1) the level of toxicity of contaminants at the site, (2) the spread of contaminants away from the source, and/or (3) the volume or amount of contaminants at the site. Long-term effectiveness and reduction of toxicity, mobility, or volume for the LNAPL recovery technologies require effective removal and collection of LNAPL floating on the water table. Removal of free-phase LNAPL may be supplemented by destruction or vapor extraction of LNAPL from the unsaturated zone. Long-term effectiveness is measured by a combination of the rate of LNAPL recovery, the total quantity of LNAPL that can be recovered, and the purity of the recovered LNAPL.

Short-term effectiveness refers to the control of adverse impacts on human health and the environment imposed during the construction and implementation of an alternative until cleanup goals have been achieved. Short-term effectiveness accounts for potential effects of the contaminants on human health and the environment during the implementation of the remedial alternative. Short-term effectiveness implies equipment that can be installed and operated with minimum hazards to the site workers and minimum unfavorable effects to the environment, and that the remediation objectives can be achieved in a reasonable period of time.

The implementability of a remedial alternative from a technical and administrative standpoint is determined by the availability of goods and services required to install the system and utilities, infrastructure, monitoring and analytical capabilities, and support systems required to operate the system. Most importantly, the current status and maturity of the treatment must be factored into the evaluation of implementability.

The cost criterion refers to the initial capital cost to design, purchase, and install the remedial alternative as well as the cost of operating and maintaining the alternative. The cost estimates for the

detailed screening typically are prepared as budget estimates with an expected accuracy of -30% to +50%.

6.1 Effectiveness

When the in situ conditions are favorable, all of the technologies reviewed in the detailed screening can be effective for recovery of LNAPL floating on the water table. The LNAPL is recovered as a single-phase liquid and is suitable as fuel for energy recovery boilers. Recovery and reuse provide permanent removal and destruction of the contaminants and allow energy conservation. Technologies providing permanent solutions to contamination are strongly favored in both CERCLA and RCRA remedial actions.

Technologies that allow reuse are favored over treatment technologies.

Based on results from the Bioslurper Initiative and other tests of vacuum-enhanced LNAPL recovery reported in the literature (Baker, 1995; Connolly et al., 1995), bioslurping recovers LNAPL at a higher rate and more completely removes LNAPL from the in situ formation than does either drawdown pumping or skimming. Bioslurping gave an LNAPL recovery rate from 1.25 to 90 times higher than the rate with skimming except at Tyndall AFB MW-5, where skimming gave a slightly higher rate. Bioslurping also has an advantage when comparing its LNAPL recovery rate with the rate achieved by drawdown pumping, but the advantage is not as large. Bioslurping has similar or higher LNAPL recovery rates than does drawdown pumping at all sites except Tyndall AFB MW-5, where bioslurping LNAPL recovery was low. Bioslurping is the only technology that was able to recover LNAPL at every test site where LNAPL was recovered. Skimming had a low or zero LNAPL recovery rate at most of the test sites. Drawdown pumping had a zero LNAPL recovery rate at two sites. None of the technologies recovered LNAPL at March AFB MW-04. All of the technologies typically provide some reduction in the volume of contaminants in the environment but do not remediate a contaminated site to background levels.

Drawdown pumping and skimming can be effective for removal actions to recover spilled separate-phase liquids, for interim actions to control contaminants while more complete remedies are being studied, as a first step during in situ remediation, or to reduce the quantity of mobile LNAPL in preparation for intrinsic remediation.

Bioslurping can be as effective in these roles as skimming or drawdown pumping but also promotes bioremediation of soil in the unsaturated zone. Bioslurping gives a higher LNAPL recovery rate than does skimming and a similar or higher LNAPL recovery rate than does drawdown pumping. Bioslurping also provides the possibility of more complete remediation and greater flexibility by allowing the ability to shift to bioventing operation with no additional cost for equipment purchase or installation. Bioslurping is unlikely to achieve cleanup to near background levels, but may be a viable remedial alternative when industrial activities will continue at the site and cleanup to background levels is not required.

Bioslurping increases LNAPL flow into an extraction well by reducing the pressure in the well. Based on data collected during the Bioslurper Initiative, the LNAPL flow is increased by a factor of 6.8 (21/3.1) compared to skimming, or 4.7 (21/4.5) compared to drawdown pumping (see Table 5-1). The entrainment action in the bioslurper well carries some water along with the LNAPL. Bioslurping is expected to bring a similar amount or less groundwater to the surface than does drawdown pumping. The average groundwater removal rate for bioslurping was about 10% higher than the average rate for drawdown pumping (see Table 5-2). The average is strongly affected by the large discrepancy in groundwater removal measured at McGuire AFB, New Jersey, where the rates for

bioslurping and drawdown pumping were 4,600 gal/d and 730 gal/d, respectively. This wide difference is not characteristic of most sites, as indicated by the relative water removal rate at each site (Table 5-2). Bioslurping had similar or slightly better performance at most of the sites when compared to drawdown pumping. Bioslurping removed water at a much higher rate compared to drawdown pumping only at the Havre MW-7 and McGuire sites. The results at McGuire, where the water recovery rate was unusually high, distort the average water removal comparison. When the relative water removal rate for each site is averaged, bioslurping shows a 4% lower relative water recovery rate (Table 5-2). If the averages are calculated without the McGuire flows, the averages for bioslurping and drawdown pumping are 1,619 gal/d and 1,715 gal/d, respectively.

Bioslurping generally removes groundwater at a similar rate compared to drawdown pumping, while recovering LNAPL at a higher rate. Bioslurping removes a smaller volume of groundwater per unit of LNAPL recovered compared to drawdown pumping, resulting in less water to treat per unit of LNAPL recovered (see Table 5-3).

Bioslurping reduces the level of the water table to a lesser extent than drawdown pumping. Removal of LNAPL and water with single- and dual-pump drawdown systems creates a cone of depression around the well. The resulting drawdown increases the well's capture zone and the hydraulic gradient, which in turn increases the pressure potential driving LNAPL flow into the well. However, this temporary lowering of the water table has an undesirable side effect (Keet, 1995). As the water table level drops, new areas of soil are exposed to LNAPL that enters pores in the soil. A significant mass of LNAPL may enter pore spaces below the former water table level. This LNAPL does not move to the recovery well and tends to become trapped and immobilized in the soil when pumping stops and the water table rises (Johnson, 1989). This trapped LNAPL becomes a long-term source of groundwater contamination (Baker, 1995). Skimming avoids the LNAPL smearing effect by not lowering the water table but does not increase the driving force for LNAPL flow.

Bioslurping induces airflow in the unsaturated zone, which helps promote biological degradation of contaminants at sites where biological activity is limited by oxygen supply. Neither skimming nor pumping is effective for remediation of unsaturated soil. When the LNAPL recovery rate drops to uneconomical rates, a bioslurping system can be quickly converted to operate in a bioventing or soil vapor extraction mode. The ability to continue remediation of the unsaturated zone without purchase of additional capital equipment gives a bioslurping system operational flexibility not available with skimming and pumping systems. These conventional LNAPL recovery technologies must be removed and replaced with new equipment if continued unsaturated zone remediation is required. The benefits of remediation in the unsaturated zone could be achieved by following the pumping or skimming process with a treatment such as soil vapor extraction or bioventing. However, this additional treatment would increase both the cost and the time required for the remediation.

The depth of application of bioslurping is not restricted by the normal suction head limits of a standard pumping system. With bioslurping, ambient air pressure is not needed to support a column of fluid to provide lift to the pump because bioslurping lifts fluids by entrainment of droplets and friction drag of fluid up the wall of the slurping tube. As a result, the bioslurping vacuum pump can lift fluids from deeper than 25 feet. Increased depth to the water table will require a longer slurping tube resulting in increased pressure drop for air flowing up the tube. The depth limit to the application of bioslurping is where the increased pressure drop eventually reduces the air velocity so low that LNAPL and water can no longer be lifted. Although the depth limit has not yet been determined, it may exceed 200 feet based on performance at Williams AFB.

6.2 Implementability

There is no significant barrier to implementation of any of the candidate technologies. All of the technologies use simple equipment and monitoring methods that are readily available from a range of vendors.

Skimming and pumping require installation of LNAPL collection devices in each well. The selective scavenger of the skimming system (mesh, wick, or belt) must be installed at the groundwater level in each well. Drawdown pumping also typically is done by installing one or two pumps in each well. In theory, drawdown pumping can be performed with one or two pumps on the surface serving several wells, if the groundwater level (including the required drawdown) is less than about 25 feet below the surface. In practice, obtaining the required flow from each well is difficult when a conventional drawdown system uses centralized pumping from the surface.

The bioslurping system is more amenable to using a centralized pump serving several wells. The entrainment action and drag fluid lift of the bioslurper are not controlled by the maximum practical suction lift. The fluid level in the well is controlled by the position of the slurping tube. When the fluid flow rate into the well is low, the tube draws in air. The slurping action lifts fluid only when water or LNAPL flows into the well so the bioslurper is self-adjusting and does not depend on a level detector controlling pumps to regulate flow. The bioslurper system has less equipment in each well (i.e., one slurper tube compared to a skimmer or pumps). Simpler in-well equipment makes the bioslurper easier to install and more stable to operate compared to skimming or pumping systems.

6.3 Cost

The estimated capital cost plus operating cost for 6 months of operation for each remedial alternative are shown in Table 6-1. The costs shown assume no off-gas treatment system is used for any of the options. System costs are obtained from Tables 54 through 5-7. Bioslurping provides bioremediation in the unsaturated zone, whereas the skimming and pumping technologies only recover free product.

Table 6-1. Total Costs for 6 Months of Operation with Each Remedial Alternative

Remedial Technology	Base Cost (\$)	Cost with Vapor Reinjection (\$)	Cost with Off- Gas Treatment (\$)
Skimming and bioventing ^(a)	\$189,248	Not Applicable	Not Applicable
Single-pump drawdown and bioventing ^(a)	\$210,980	Not Applicable	Not Applicable
Dual-pump drawdown and bioventing ^(a)	\$252,802	Not Applicable	Not Applicable
Bioslurping	\$166,559	\$194,939	\$210,399

(a) Cost for bioventing based on design installation, startup, and utilities for a 5,000-yd³ site from Section 7.0 of Leeson et al. (1995).

Therefore, a cost of \$12,200 is added to skimming and pumping technologies to account for design, installation, startup, and operation of a bioventing system (Leeson et al., 1995). A bioventing supplement would be needed to allow the conventional technologies to equal the performance of bioslurping. In addition, costs are tabulated for a bioslurping system with off-gas reinjection and a

bioslurping system with off-gas treatment with an internal combustion engine. If the contaminant vapor concentration in the off-gas is too high to allow direct discharge or economical treatment with disposable carbon adsorbers, reinjection is a cost-effective treatment approach. The cost of reinjection, \$28,380 for 6 months of operation, is obtained from Table 5-8. The acceptance of reinjection may be limited by technical issues such as low soil permeability, nearby subsurface structures, or shallow groundwater depth, or by regulatory considerations. The catalytic incineration treatment system gives a good basis for estimating off-gas treatment costs for sites where direct discharge or reinjection cannot be used. The cost for catalytic incineration, \$43,840 for 6 months of operation, is obtained from Table 5-10. For high vapor concentrations the ICE treatment system has lower costs than catalytic incineration, so ICE treatment would be selected when the vapor concentration is over 25 % or the LEL.

The costs for bioslurping are similar to or lower than the costs for other technologies. Table 6-2 gives a tabulation of the cost savings or increase if bioslurping is used to replace skimming, single-pump drawdown, or dual-pump drawdown. With direct discharge or reinjection of off-gas, bioslurping clearly is cost-effective compared to conventional technologies. When more costly off-gas treatment is required, bioslurping costs are in the same range as the other LNAPL recovery technologies.

Table 6-2. Cost Savings for Bioslurping Compared to Conventional LNAPL Recovery Technologies

Remedial Technology	Cost Savings for Bioslurping Relative to Other Remedial Alternatives		
	No Off-Gas Treatment (Δ\$)	Vapor Reinjection (Δ\$)	Vapor Treatment (Δ\$)
Skimming	\$22,689	\$5,691 ^(a)	(\$21,151) ^(a)
Single-pump drawdown	\$44,421	\$16,041	(\$581)
Dual-pump drawdown	\$86,243	\$57,863	\$42,403

(a) Bioslurping with reinjection or off-gas treatment is more costly than the skimming alternative.

Given the similar or lower costs and the potential for better performance, bioslurping is more cost-effective than the conventional LNAPL recovery technologies. As discussed in Section 6.1, field testing indicates that bioslurping can be significantly more effective at recovering LNAPL compared to the conventional technologies. As summarized in Table 6-2, bioslurping is less expensive than the other three alternatives both when no off-gas treatment is needed and when off-gas can be treated by reinjection. If the bioslurping system off-gas requires more intensive treatment, represented by thermal treatment in an ICE unit, the cost for 6 months of operation is still lower than the cost for dual-pump drawdown. The cost for bioslurping plus an ICE treatment unit is slightly higher when compared to the costs for skimming and single-pump drawdown pumping.

The evaluation of cost assumes that all of the remedial alternatives operate for 6 months. The LNAPL recovery rates measured in the study indicate that bioslurping would complete LNAPL recovery operations much faster than skimming and somewhat faster than drawdown pumping. However,

bioslurping also may recover more LNAPL in addition to achieving a faster recovery rate so the decrease in operating time, if any, is difficult to quantify. The fixed operating period is used in the cost estimates to give a consistent basis for comparison and understates the cost advantage of bioslurping. As an indication of the relative magnitude of the effect of the high LNAPL recovery rate with bioslurping, the cost per unit of LNAPL recovered is shown in Table 6-3. The cost is calculated assuming that the average LNAPL recovery rate for each system (3.1 gal/d for skimming, 4.5 gal/day for single-pump or dual-pump drawdown, and 21 gal/d for bioslurping) is sustained for a period of 6 months. The assumption of uniform recovery rate for 6 months is artificial but provides a standard basis to normalize treatment costs to allow a direct comparison. As shown, even with off-gas treatment, bioslurping, with a unit cost of \$56/gal, is dramatically more cost-effective than the conventional technologies.

Table 6-3. Comparison of Unit Cost for LNAPL Recovery

Remedial Technology	LNAPL Recovered in 6-Month Operation (gal)	Unit Cost for Recovery (\$/gal)
Skimming	558	339
Single-pump drawdown	810	260
Dual-pump drawdown	810	312
Bioslurping (with off-gas treatment)	3,780	56

6.4 Other Factors

Bioslurping can improve biodegradation of petroleum contaminants by increasing aeration in the unsaturated zone, whereas skimming and pumping technologies do not. The added benefit of this bioventing action has been demonstrated by numerous tests and applications (Hinchee et al., 1995). The potential for enhanced biodegradation at the test sites in the Bioslurper Initiative was demonstrated by in situ respiration tests. The bioslurping system will, therefore, provide remediation of the unsaturated zone while it is recovering LNAPL. The conventional skimming and pumping technologies do not provide this benefit. Data collected -during the Bioslurper Initiative were insufficient to quantify the added benefit of soil aeration that occurs during the bioslurping. However, it is important to note that to provide equivalent performance the skimming and pumping systems would need to be supplemented with bioventing systems.

It is difficult to assess regulatory or stakeholder reaction to any of the technologies prior to identification of a site. All of the technologies recover LNAPL in a potentially useful form and should be favored as providing an opportunity for recycling rather than treatment. The bioslurper system produces an off-gas stream, but off-gas production would not be expected to increase regulatory resistance, as long as treatment is provided to meet local requirements. The economics of providing the treatment will depend on local conditions, as discussed above.

7.0 SUMMARY AND CONCLUSIONS

Where floating product forms a lens on the water table indicating that the soils are saturated with LNAPL, conventional free-product recovery by skimming or pumping generally is effective. The conventional approaches are particularly effective when the saturated zone is in permeable soils such as sands and gravels. Skimming will recover LNAPL with little or no water, whereas single-pump drawdown systems recover a mixture of LNAPL and water. A dual-pump system can recover LNAPL and water as separate streams, but using the dual-pump approach increases the system cost and still brings groundwater to the surface which must then be managed. Skimming recovers LNAPL at a lower rate than either pumping method.

Application of vacuum to enhance LNAPL recovery can increase both the speed and completeness of LNAPL removal. Application of negative pressure in an extraction well increases the driving force for advection into the well without requiring the water level to be lowered. The increased driving force recovered, significant LNAPL remains trapped in the soil pores. Bioslurping can mobilize a portion of the LNAPL by applying a negative pressure in the soil porosity around the bioslurping well while water and LNAPL are extracted. If the vacuum being exerted on the formation is sufficient, capillary forces holding LNAPL in the pores is overcome and the fluid is pulled from the pores and moved to the extraction well.

Bioslurping stimulates biological degradation of organic contaminants in the unsaturated zone during operation and is easily converted to perform bioventing for continued remediation after all free LNAPL has been recovered. The air withdrawal during bioslurping aerates the soil, which will increase the biodegradation rates at sites where biological activity is limited by oxygen availability in the soil. If organic contaminants remain in the unsaturated zone after the LNAPL has been removed the slurping tube can be removed or raised above the water table level to allow continued operation as a bioventing system. If bioventing is required to finish cleanup at a site where skimming or pumping has been used for LNAPL recovery, additional equipment must be purchased and installed.

8.0 REFERENCES

AFCEE. 1992. *Remedial Technology Design, Performance, and Cost Study*. Environmental Services Office, Air Force Center for Environmental Excellence, Brooks Air Force Base, TX.

AFCEE. 1994. *A Performance and Cost Evaluation of Internal Combustion Engines for the Destruction of Hydrocarbon Vapors from Fuel-Contaminated Soils*. Prepared by S.R. Archabal and D.C. Downey. Environmental Services Office, Air Force Center for Environmental Excellence, Brooks Air Force Base, TX.

AFCEE. 1995a. *Test Plan and Technical Protocol for Bioslurping, Rev. 2*. Air Force Center for Environmental Excellence (AFCEE), Brooks Air Force Base, TX. January.

AFCEE. 1995b. *Technical Protocol for Implementing Intrinsic Remediation with Long-Term Monitoring for Natural Attenuation of Fuel Contamination Dissolved in Groundwater*. Prepared by T. Wiedemeier, Parsons Engineering Science, Inc.; J.T. Wilson and D.H. Kampbell, U.S. Environmental Protection Agency; and R.N. Miller and J.E. Hansen, AFCEE. Technology Transfer

Division, U.S. Air Force Center for Environmental Excellence, Brooks AFB, San Antonio, TX. November.

Baker, R. S. 1995. "One-, Two-, and Three-Phase Flow During Free-Product Recovery. In R. E. Hinchee, J. A. Kittel, and H. J. Reisinger (Eds.), *Applied Bioremediation of Petroleum Hydrocarbons*, pp. 349-359. Battelle Press, Columbus, OH.

Barnes, D. L., and D. B. McWhorter. 1995. "Mechanics of Vacuum-Enhanced Recovery of Hydrocarbons. In R. E. Hinchee, J. A. Kidel, and H. J. Reisinger (Eds.), *Applied Bioremediation of Petroleum Hydrocarbons*, pp. 361-370. Battelle Press, Columbus, OH.

Buck, F.A.M., and C. W. Hauck. 1992. "Vapor Extraction and Catalytic Oxidation of Chlorinated VOCs." *Proceedings of the 11th Annual Incineration Conference*. Albuquerque, NM, May.

Catalan, L.J.J., and F.A.L. Dullien. 1995. "Application of Gravity Drainage to the Recovery of Residual LNAPL in Homogeneous and Lensed Sand Packs." *Journal of Contaminant Hydrology*, 18:279-306.

Cohen, R. M., and J. W. Mercer. 1993. *DNAPL Site Evaluation*. Prepared by GeoTrans, Inc., Sterling, VA, for U.S. Environmental Protection Agency, Robert S. Kerr Environmental Research Laboratory, Ada, OK.

Connolly, M., B. Gibbs, and B. Keet. 1995. "Bioslurping Applied to a Gasoline and Diesel Spill in Fractured Rock." In R. E. Hinchee, J. A. Kittel, and H. J. Reisinger (Eds.), *Applied Bioremediation of Petroleum Hydrocarbons*, pp. 371-377. Battelle Press, Columbus, OH.

CSM Systems, 1989. Company literature. CSM Systems, Inc. Brooklyn, NY.

Dean, J. A. 1992. *Lange's Handbook of Chemistry*, 14th ed. McGraw-Hill, New York, NY.

Dev, H., J. Enk, G. Sresty, J. Bridges, and D. Downey, 1989. *In Situ Soil Decontamination by Radio-Frequency Heating-Field Test*. ESL-TR-88-62. Air Force Engineering & Services Center. Tyndall Air Force Base, FL.

Downey, D. C., C. J. Pluhar, L. A. Dudus, P. G. Blystone, R. N. Miller, G. L. Lane, and S. Taffinder. 1994. "Remediation of Gasoline-Contaminated Soils Using Regenerative Resin Vapor Treatment and In Situ Bioventing." *Proceedings of the Petroleum Hydrocarbons and Organic Chemicals Ground Water: Prevention, Detection, and Restoration Conference*.

Dupont, R. R., W. J. Doucette, and R. E. Hinchee. 1991. "Assessment of In Situ Bioremediation Potential and the Application of Bioventing at a Fuel-Contaminated Site." In R. E. Hinchee and R. F. Olfenbittel (Eds.), *In Situ Bioreclamation: Applications and Investigations for Hydrocarbon and Contaminated Site Remediation*, pp. 262-282. Butterworth-Heinemann, Stoneham, MA.

Edelstein, W.A., I.E.T Iben, O.M. Mueller, E.E. Uzgiris, H.R. Philipp, and P.B. Roemer. 1994. "Radiofrequency Ground Heating for Soil Remediation: Science and Engineering." *Environmental Progress*, 13(4):247-252.

- Hazardous Waste Consultant. 1996. "Risk Assessment is Popular for All Types of Cleanups." *Hazardous Waste Consultant*, 14(3):1.17-1.22.
- Herrling, B., J. Stamm, E. J. Alesi, G. Bott-Breuning, and S. Diekmann. 1994. "In Situ Bioremediation of Groundwater Containing Hydrocarbons, Pesticides, or Nitrate Using Vertical Circulation Flows (WB/GZB Technique)." In R. E. Hinchee (Ed.), *Air Sparging for Site Remediation*, pp. 56-80. CRC Press, Boca Raton, FL.
- Hinchee, R. E. 1994. "Air Sparging State of the Art." In R. E. Hinchee (Ed.), *Air Sparging for Site Remediation*. pp. 1-13. Lewis Publishers, Boca Raton, FL.
- Hinchee, R. E., R. N. Miller, and P. C. Johnson. 1995. *In Situ Aeration: Air Sparging, Bioventing, and Related Remediation Processes*. Battelle Press, Columbus, OH.
- Hobson, T. 1996. "Skimming Oily Wastewater." *Pollution Engineering*, 28(10):52-54.
- Johnson, R. L. 1989. "Soil Venting for Remediation of Subsurface Gasoline Releases." *Proceedings of the Petroleum Hydrocarbon and Organic Chemicals in Ground Water: Prevention, Detection, and Restoration Conference and Exposition*. National Water Well Association and American Petroleum Institute, Houston, TX.
- Johnson, R. L. 1994. "Enhancing Biodegradation with In Situ Air Sparging: A Conceptual Model." In R.E. Hinchee (Ed.), *Air Sparging for Site Remediation*. pp. 14-22. Lewis Publishers, Boca Raton, FL.
- Johnson, P. C., C. C. Stanley, M. W. Kemblowski, D. L. Byers, and J. D. Colthart. 1990. "A Practical Approach to the Design, Operation, and Monitoring of In Situ Soil-Venting Systems." *Ground Water Monitoring Review*, 10(2):159-178. Spring.
- Kaluarachchi, J.J. 1996. "Effect of Subsurface Heterogeneity on Free-Product Recovery from Unconfined Aquifers." *Journal of Contaminant Hydrology*, 22(1):19-37.
- Kasevich, R., R. Holmes, D. Faust, and R. Beleski. 1993. "Radio Frequency Heat Enhances Contaminant Removal." *Soils*, pp. 18-23. March.
- Keet, B. A. 1995. "Bioslurping State of the Art." In R. E. Hinchee, J. A. Kittel and H. J. Reisinger (Eds.), *Applied Bioremediation of Petroleum Hydrocarbons*, pp. 329-334. Battelle Press, Columbus, OH.
- Kiang, Y.-H. 1988. "Catalytic Incineration." In Harry Freeman (Ed.), *Standard Handbook of Hazardous Waste Treatment and Disposal*. McGraw-Hill, New York, NY.
- Leeson, A., R. E. Hinchee, J. A. Kittel, and E. A. Foote. 1995. *Enviro-nics TOC Task 3, Bioventing Feasibility Study, Eielson AFB Site*, Final Report. Prepared by Battelle, Columbus, OH for the Environmental Quality Directorate of the Armstrong Laboratory, Tyndall AFB, FL.
- Leeson, A., R. E. Hinchee, J. A. Kittel, G. Sayles, C. Vogel, and R. N. Miller. 1993. "Optimizing Bioventing in Shallow Vadose Zones and Cold Climates." *Hydrological Science Journal*, 38(4): 283-295.

Lide, D. R., and H.P.R. Frederikse (Eds.). 1993. *CRC Handbook of Chemistry and Physics*, 74th ed. CRC Press, Boca Raton, FL.

Little, A. D. 1987. *The Installation Restoration Program Toxicology Guide*, Vol. 3. Prepared for the Aerospace Medical Division. U.S. Air Force Systems Command, Wright-Patterson Air Force Base, Dayton, OH.

Mackay, D., and W. Y. Shiu. 1981. A Critical Review of Henry's Law Constants for Chemicals of Environmental Interest." *J. Phys. Chem. Ref. Data*, 10(4):1175.

Mukhopadhyay, N., and E. C. Moretti. 1993. *Current and Potential Future Industrial Practices for Reducing and Controlling Volatile Organic Compounds*. Center for Waste Reduction Technologies, American Institute of Chemical Engineers, New York, NY.

Nyer, E. K. 1992. *Groundwater Treatment Technology*. Van Nostrand Reinhold, New York, NY.

Palmer, C. D., and P. R. Wittbrodt. 1991. "Processes Affecting the Remediation of Chromium-Contaminated Sites." *Environmental Health Perspectives* 92:2540.

Richardson Engineering Services, Inc. 1995. *The Richardson Construction Cost Trend Reporter*.

Rosansky, S., J. Kittel, T. Zwick, and L.A. Smith. 1996. Draft Interim Report for Evaluating the Potential for Recovering Light, -Phase Liquid Using Bioslurping Technology at Travis Air Force Base. Prepared for U.S. Air Force Center for Environmental Excellence, Brooks AFB, San Antonio, TX. February.

Roy F. Weston, Inc. and IIT Research Institute. 1992. *Final Rocky Mountain Arsenal In Situ Radio Frequency Heating/Vapor Extraction Pilot Test Report*, Vol. I, 5300-01-12-AAFP. Rocky Mountain Arsenal, Commerce City, CO.

Rubin, D.K. 1995. "Industrial Cleanup Market Heats Up for Flameless Technology Vendor." *Engineering News Record*, 235(8):52-53.

Schleyer, C.A.J. 1987. "Three Low Cost Pumping Systems for Hydrocarbon Contaminated Ground Water." *Proceedings of the NWWA/API Conference on Petroleum Hydrocarbons and Organic Chemicals in Groundwater-Prevention, Detection, and Restoration*. Houston, Texas. November 17-19. Published by the National Well Water Association, Dublin, OH.

Skladany, G. J., A. P. Togna, and Y. Yang. 1994. "Using Biofiltration to Treat VOCs and Odors." *Superfund XIV Conference and Exhibition*. Hazardous Materials Control Resources Institute, Rockville, MD.

Smith, G. J., R. R. DuPont, and R. E. Hincee. 1991. *Final Report on Hill AFB JP-4 Site (Building 914) Remediation*. Report submitted to Hill AFB by Battelle, Columbus, OH.

Smith, L. A., and R. E. Hincee. 1993. *In Situ Thermal Technologies for Site Remediation*. Lewis Publishers, Ann Arbor, MI.

U.S. Department of Health & Human Services. 1993a. *Toxicological Profile for Automotive Gasoline*. U.S. Department of Health & Human Services, Agency for Toxic Substances and Disease Registry, Atlanta, GA.

U.S. Department of Health & Human Services. 1993b. *Toxicological Profile for Fuel Oils*. U.S. Atlanta, GA.

U.S. Department of Health & Human Services. 1993c. *Toxicological Profile for Jet Fuels JP-4 and JP-7*. U.S. Department of Health & Human Services, Agency for Toxic Substances and Disease Registry, Atlanta, GA.

U.S. Environmental Protection Agency. 1985. *Handbook: Remedial Action at Waste Disposal Sites*. EPA/625/6-85/006. Office of Emergency and Emergency Response, Washington, DC.

U.S. Environmental Protection Agency. 1986. *Control Technologies for Hazardous Air Pollutants*. EPA/625/6-86/014.

U.S. Environmental Protection Agency. 1986. *Quality Criteria for Water 1986*. EPA/440/5-86/001; Office of Water. Washington, DC, May 1. (also with Update No. 1, 1986 and Update No. 2, 1987).

U.S. Environmental Protection Agency. 1988. *Cleanup of Releases from Petroleum USTs: Selected Technologies*. EPA 530/UST-88/001. Office of Solid Waste and Emergency Response, Washington, DC.

U.S. Environmental Protection Agency. 1989. *Terra Vac In Situ Vacuum Extraction System-Applications Analysis Report*. EPA/540/A5-89/003. Office of Research and Development, Risk Reduction Engineering Laboratory, Cincinnati, OH.

U.S. Environmental Protection Agency. 1989. *Project Summary: Radiofrequency Enhanced Decontamination of Soils Contaminated with Halogenated Hydrocarbons*. EPA/600/S2-89/008. Office of Research and Development, Risk Reduction Engineering Laboratory. Cincinnati, OH.

U.S. Environmental Protection Agency. 1990. *Assessing UST Corrective Action Technologies: Site Assessment and Selection of Unsaturated Zone Treatment Technologies*. EPA/600/2-90/011. Office of Research and Development, Risk Reduction Engineering Laboratory, Cincinnati, OH.

U.S. Environmental Protection Agency. 1990. *Cost of Remedial Action Model Version 3.0.937.5-06/FS*. Office of Solid Waste and Emergency Response. Washington, DC.

U.S. Environmental Protection Agency. 1991. *Soil Vapor Extraction Technology: Reference Handbook*. EPA/540/2-91/003. Office of Research and Development, Risk Reduction Engineering Laboratory, Cincinnati, OH.

U.S. Environmental Protection Agency. 1991. *Engineering Bulletin: In Situ Steam Extraction Treatment*. EPA/540/2-91/005. Office of Emergency and Remedial Response, Washington, DC; and Office of Research and Development, Risk Reduction Engineering Laboratory, Cincinnati, OH.

U.S. Environmental Protection Agency. 1991. *Engineering Bulletin: In Situ Soil Vapor Extraction Treatment*. EPA/540/2-91/006. Office of Emergency and Remedial Response, Washington, DC; and Office of Research and Development, Risk Reduction Engineering Laboratory, Cincinnati, OH.

U.S. Environmental Protection Agency. 1991. *Soil Vapor Extraction Technology Reference Handbook*. EPA/540/2-91/003. Office of Research and Development, Risk Reduction Research Engineering Laboratory, Cincinnati, OH.

U.S. Environmental Protection Agency. 1991. *Toxic Treatments, In Situ Steam/Hot Air Stripping Technology-Applications Analysis Report*. EPA/540/A5-90/008. Office of Research and Development, Risk Reduction Engineering Laboratory, Cincinnati, OH.

U.S. Environmental Protection Agency. 1991. *AWD Technologies Integrated AquaDetox[®]/SVE Technology - Applications Analysis Report*. EPA/540/A5-91/002. Office of Research and Development, Risk Reduction Engineering Laboratory, Cincinnati, OH.

U.S. Environmental Protection Agency. 1993. *Engineering Issue: In Situ Bioremediation of Contaminated Unsaturated Subsurface Soils*. EPA/5401S-93/501. Office of Research and Development, Robert S. Kerr Environmental Research Laboratory, Ada, OK; and Office of Solid Waste and Emergency Response, Washington, DC.

U.S. Environmental Protection Agency. 1993. *Synopses of Federal Demonstrations of Innovative Site Remediation Technologies*. EPA/5421B-93/009. Federal Remediation Technologies Roundtable, Washington, DC.

U.S. Environmental Protection Agency. 1994. *SITE Demonstration Bulletin-Radiofrequency Heating - IIT Research Institute*. EPA/540/MR-94/527. Office of Research and Development, Washington, DC.

U.S. Environmental Protection Agency. 1994. *SITE Demonstration Bulletin – Radiofrequency Heating-K4I Technologies*. EPA/540/MR-94/528. Office of Research and Development, Washington, DC.

U.S. Environmental Protection Agency. 1994. *Superfund Innovative Technology Evaluation Program-Technology Profiles*, 7th ed. EPA/540/R-94/526. Office of Research and Development, Washington, DC.

U.S. Environmental Protection Agency. 1994. *VISITT Vendor Information System for Innovative Treatment Technologies - User Manual (Version 3.0) with Update to Version 4.0*. EPA/542/ R-94/003. Office of Solid Waste and Emergency Response, Washington, DC. For information on updates, call the VISITT Hotline, (800) 2454505.

U.S. Environmental Protection Agency. 1994. *Innovative Treatment Technologies: Annual Status Report*. EPA/542/R-94/005. Office of Solid Waste and Emergency Response, Washington, DC.

U.S. Environmental Protection Agency. 1994. *Evaluation of Technologies for In Situ Cleanup of DNAPL Contaminated Sites*. EPA/600/R-94/120. Robert S. Kerr Environmental Research Laboratory, Ada, OK.

U.S. Environmental Protection Agency. 1995. *Ground Water Issue-Light Nonaqueous Phase Liquids*. EPA/540/S-95/500. Office of Research and Development and Office of Solid Waste and Emergency Response, Washington, DC.

Reference Guide. Draft report. U.S. EPA, Technology Innovation Office, Washington, DC; and U.S. Air Force, Armstrong Laboratory Environics Directorate, Tyndall Air Force Base, FL.

Vatavuk, W. M. 1990. *Estimating Costs of Air Pollution Control*. Lewis Publishers, Boca Raton, FL.

Verschuere, K. 1983. *Handbook of Environmental Data on Organic Chemicals*, 2nd ed. Van Nostrand Reinhold Co., New York, NY.

Waier, P. R. (Ed.). 1994. *Means Building Construction Cost Data*, 53rd ed. R.S. Means Co., Inc