



Technical Protocol for Evaluating Natural Attenuation of Chlorinated Solvents in Ground Water



TECHNICAL PROTOCOL FOR EVALUATING NATURAL ATTENUATION OF CHLORINATED SOLVENTS IN GROUND WATER

by

Todd H. Wiedemeier
Parsons Engineering Science, Inc.
Pasadena, California

Matthew A. Swanson, David E. Moutoux, and E. Kinzie Gordon
Parsons Engineering Science, Inc.
Denver, Colorado

John T. Wilson, Barbara H. Wilson, and Donald H. Kampbell
United States Environmental Protection Agency
National Risk Management Research Laboratory
Subsurface Protection and Remediation Division
Ada, Oklahoma

Patrick E. Haas, Ross N. Miller and Jerry E. Hansen
Air Force Center for Environmental Excellence
Technology Transfer Division
Brooks Air Force Base, Texas

Francis H. Chapelle
United States Geological Survey
Columbia, South Carolina

IAG #RW57936164

Project Officer
John T. Wilson
National Risk Management Research Laboratory
Subsurface Protection and Remediation Division
Ada, Oklahoma

NATIONAL RISK MANAGEMENT RESEARCH LABORATORY
OFFICE OF RESEARCH AND DEVELOPMENT
U. S. ENVIRONMENTAL PROTECTION AGENCY
CINCINNATI, OHIO 45268

NOTICE

The information in this document was developed through a collaboration between the U.S. EPA (Subsurface Protection and Remediation Division, National Risk Management Research Laboratory, Robert S. Kerr Environmental Research Center, Ada, Oklahoma [SPRD]) and the U.S. Air Force (U.S. Air Force Center for Environmental Excellence, Brooks Air Force Base, Texas [AFCEE]). EPA staff were primarily responsible for development of the conceptual framework for the approach presented in this document; staff of the U.S. Air Force and their contractors also provided substantive input. The U.S. Air Force was primarily responsible for field testing the approach presented in this document. Through a contract with Parsons Engineering Science, Inc., the U.S. Air Force applied the approach at chlorinated solvent plumes at a number of U.S. Air Force Bases. EPA staff conducted field sampling and analysis with support from ManTech Environmental Research Services Corp., the in-house analytical support contractor for SPRD.

All data generated by EPA staff or by ManTech Environmental Research Services Corp. were collected following procedures described in the field sampling Quality Assurance Plan for an in-house research project on natural attenuation, and the analytical Quality Assurance Plan for ManTech Environmental Research Services Corp.

This protocol has undergone extensive external and internal peer and administrative review by the U.S. EPA and the U.S. Air Force. This EPA Report provides technical recommendations, not policy guidance. It is not issued as an EPA Directive, and the recommendations of this EPA Report are not binding on enforcement actions carried out by the U.S. EPA or by the individual States of the United States of America. Neither the United States Government (U.S. EPA or U.S. Air Force), Parsons Engineering Science, Inc., or any of the authors or reviewers accept any liability or responsibility resulting from the use of this document. Implementation of the recommendations of the document, and the interpretation of the results provided through that implementation, are the sole responsibility of the user.

Mention of trade names or commercial products does not constitute endorsement or recommendation for use.

FOREWORD

The U.S. Environmental Protection Agency is charged by Congress with protecting the Nation's land, air, and water resources. Under a mandate of national environmental laws, the Agency strives to formulate and implement actions leading to a compatible balance between human activities and the ability of natural systems to support and nurture life. To meet these mandates, EPA's research program is providing data and technical support for solving environmental problems today and building a science knowledge base necessary to manage our ecological resources wisely, understand how pollutants affect our health, and prevent or reduce environmental risks in the future.

The National Risk Management Research Laboratory is the Agency's center for investigation of technological and management approaches for reducing risks from threats to human health and the environment. The focus of the Laboratory's research program is on methods for the prevention and control of pollution to air, land, water, and subsurface resources; protection of water quality in public water systems; remediation of contaminated sites and ground water; and prevention and control of indoor air pollution. The goal of this research effort is to catalyze development and implementation of innovative, cost-effective environmental technologies; develop scientific and engineering information needed by EPA to support regulatory and policy decisions; and provide technical support and information transfer to ensure effective implementation of environmental regulations and strategies.

The site characterization processes applied in the past are frequently inadequate to allow an objective and robust evaluation of natural attenuation. Before natural attenuation can be used in the remedy for contamination of ground water by chlorinated solvents, additional information is required on the three-dimensional flow field of contaminated ground water in the aquifer, and on the physical, chemical and biological processes that attenuate concentrations of the contaminants of concern. This document identifies parameters that are useful in the evaluation of natural attenuation of chlorinated solvents, and provides recommendations to analyze and interpret the data collected from the site characterization process. It will also allow ground-water remediation managers to incorporate natural attenuation into an integrated approach to remediation that includes an active remedy, as appropriate, as well as natural attenuation.

Clinton W. Hall, Director
Subsurface Protection and Remediation Division
National Risk Management Research Laboratory

TABLE OF CONTENTS

Notice	ii
Foreword	iii
Acknowledgments	viii
List of Acronyms and Abbreviations	ix
Definitions	xii
SECTION 1 INTRODUCTION	1
1.1 APPROPRIATE APPLICATION ON NATURAL ATTENUATION	2
1.2 ADVANTAGES AND DISADVANTAGES	4
1.3 LINES OF EVIDENCE	6
1.4 SITE CHARACTERIZATION	7
1.5 MONITORING	9
SECTION 2 PROTOCOL FOR EVALUATING NATURAL ATTENUATION	11
2.1 REVIEW AVAILABLE SITE DATA AND DEVELOP PRELIMINARY CONCEPTUAL MODEL	13
2.2 INITIAL SITE SCREENING	15
2.2.1 Overview of Chlorinated Aliphatic Hydrocarbon Biodegradation	15
2.2.1.1 Mechanisms of Chlorinated Aliphatic Hydrocarbon Biodegradation	23
2.2.1.1.1 Electron Acceptor Reactions (Reductive Dehalogenation)	23
2.2.1.1.2 Electron Donor Reactions	25
2.2.1.1.3 Cometabolism	25
2.2.1.2 Behavior of Chlorinated Solvent Plumes	26
2.2.1.2.1 Type 1 Behavior	26
2.2.1.2.2 Type 2 Behavior	26
2.2.1.2.3 Type 3 Behavior	26
2.2.1.2.4 Mixed Behavior	27
2.2.2 Bioattenuation Screening Process	27
2.3 COLLECT ADDITIONAL SITE CHARACTERIZATION DATA IN SUPPORT OF NATURAL ATTENUATION AS REQUIRED	34
2.3.1 Characterization of Soils and Aquifer Matrix Materials	37
2.3.2 Ground-water Characterization	38
2.3.2.1 Volatile and Semivolatile Organic Compounds	38
2.3.2.2 Dissolved Oxygen	38
2.3.2.3 Nitrate	39
2.3.2.4 Iron (II)	39
2.3.2.5 Sulfate	39
2.3.2.6 Methane	39
2.3.2.7 Alkalinity	39
2.3.2.8 Oxidation-Reduction Potential	40
2.3.2.9 Dissolved Hydrogen	40
2.3.2.10 pH, Temperature, and Conductivity	41
2.3.2.11 Chloride	42
2.3.3 Aquifer Parameter Estimation	42
2.3.3.1 Hydraulic Conductivity	42
2.3.3.1.1 Pumping Tests in Wells	43
2.3.3.1.2 Slug Tests in Wells	43
2.3.3.1.3 Downhole Flowmeter	43

2.3.3.2	Hydraulic Gradient	44
2.3.3.3	Processes Causing an Apparent Reduction in Total Contaminant Mass	44
2.3.4	Optional Confirmation of Biological Activity	45
2.4	REFINE CONCEPTUAL MODEL, COMPLETE PRE-MODELING CALCULATIONS, AND DOCUMENT INDICATORS OF NATURAL ATTENUATION	45
2.4.1	Conceptual Model Refinement	46
2.4.1.1	Geologic Logs	46
2.4.1.2	Cone Penetrometer Logs	46
2.4.1.3	Hydrogeologic Sections	46
2.4.1.4	Potentiometric Surface or Water Table Map(s)	47
2.4.1.5	Contaminant and Daughter Product Contour Maps	47
2.4.1.6	Electron Acceptor, Metabolic By-product, and Alkalinity Contour Maps	47
2.4.2	Pre-Modeling Calculations	48
2.4.2.1	Analysis of Contaminant, Daughter Product, Electron Acceptor, Metabolic By-product, and Total Alkalinity Data	48
2.4.2.2	Sorption and Retardation Calculations	49
2.4.2.3	NAPL/Water Partitioning Calculations	49
2.4.2.4	Ground-water Flow Velocity Calculations	49
2.4.2.5	Biodegradation Rate-Constant Calculations	49
2.5	SIMULATE NATURAL ATTENUATION USING SOLUTE FATE AND TRANSPORT MODELS	49
2.6	CONDUCT A RECEPTOR EXPOSURE PATHWAYS ANALYSIS	50
2.7	EVALUATE SUPPLEMENTAL SOURCE REMOVAL OPTIONS	50
2.8	PREPARE LONG-TERM MONITORING PLAN	50
2.9	PRESENT FINDINGS	52
SECTION 3	REFERENCES	53
APPENDIX A	A1-1
APPENDIX B	B1-1
APPENDIX C	C1-1

FIGURES

No.	Title	Page
2.1	Natural attenuation of chlorinated solvents flow chart	12
2.2	Reductive dehalogenation of chlorinated ethenes	24
2.3	Initial screening process flow chart	28
2.4	General areas for collection of screening data	31
2.5	A cross section through a hypothetical release	36
2.6	A stacked plan representation of the plumes that may develop from the hypothetical release	36
2.7	Hypothetical long-term monitoring strategy	51

TABLES

No.	Title	Page
i.	Contaminants with Federal Regulatory Standards	xiv
2.1	Soil, Soil Gas, and Ground-water Analytical Protocol	16
2.2	Objectives for Sensitivity and Precision to Implement the Natural Attenuation Protocol	21
2.3	Analytical Parameters and Weighting for Preliminary Screening for Anaerobic Biodegradation Processes	29
2.4	Interpretation of Points Awarded During Screening Step 1	32
2.5	Range of Hydrogen Concentrations for a Given Terminal Electron-Accepting Process	41

ACKNOWLEDGMENTS

The authors would like to thank Dr. Robert Hinchee, Doug Downey, and Dr. Guy Sewell for their contributions and their extensive and helpful reviews of this manuscript. Thanks also to Leigh Alvarado Benson, R. Todd Herrington, Robert Nagel, Cindy Merrill, Peter Guest, Mark Vesseley, John Hicks, and Saskia Hoffer for their contributions to this project.

LIST OF ACRONYMS AND ABBREVIATIONS

AAR	American Association of Railroads
AFB	Air Force Base
AFCEE	Air Force Center for Environmental Excellence
ASTM	American Society for Testing and Materials
bgs	below ground surface
BRA	baseline risk assessment
BRAC	Base Realignment and Closure
BTEX	benzene, toluene, ethylbenzene, xylenes
CAP	corrective action plan
CERCLA	Comprehensive Environmental Response, Compensation and Liability Act
cfm	cubic feet per minute
CFR	Code of Federal Regulations
COPC	chemical of potential concern
CPT	cone penetrometer testing
CSM	conceptual site model
DAF	dilution/attenuation factor
DERP	Defense Environmental Restoration Program
DNAPL	Dense Nonaqueous Phase Liquid
DO	dissolved oxygen
DOD	Department of Defense
DQO	data quality objective
EE/CA	engineering evaluation/cost analysis
FS	feasibility study
gpd	gallons per day
G_r	standard (Gibbs) free energy
HDPE	high-density polyethylene
HSSM	Hydrocarbon Spill Screening Model
HSWA	Hazardous and Solid Waste Amendments of 1984
ID	inside-diameter
IDW	investigation derived waste
IRP	Installation Restoration Program
L	liter
LEL	lower explosive limit
LNAPL	light nonaqueous-phase liquid
LUFT	leaking underground fuel tank
MAP	management action plan
MCL	maximum contaminant level

MDL	method detection limit
µg	microgram
µg/kg	microgram per kilogram
µg/L	microgram per liter
mg	milligram
mg/kg	milligrams per kilogram
mg/L	milligrams per liter
mg/m ³	milligrams per cubic meter
mm Hg	millimeters of mercury
MOC	method of characteristics
MOGAS	motor gasoline
NAPL	nonaqueous-phase liquid
NCP	National Contingency Plan
NFRAP	no further response action plan
NOAA	National Oceanographic and Atmospheric Administration
NOEL	no-observed-effect level
NPL	National Priorities List
OD	outside-diameter
ORP	oxidation-reduction potential
OSHA	Occupational Safety and Health Administration
OSWER	Office of Solid Waste and Emergency Response
PAH	polycyclic aromatic hydrocarbon
PEL	permissible exposure limit
POA	point-of-action
POC	point-of-compliance
POL	petroleum, oil, and lubricant
ppmv	parts per million per volume
psi	pounds per square inch
PVC	polyvinyl chloride
QA	quality assurance
QC	quality control
RAP	remedial action plan
RBCA	risk-based corrective action
RBSL	risk-based screening level
redox	reduction/oxidation
RFI	RCRA facility investigation
RI	remedial investigation
RME	reasonable maximum exposure
RPM	remedial project manager
SAP	sampling and analysis plan
SARA	Superfund Amendments and Reauthorization Act
scfm	standard cubic feet per minute
SPCC	spill prevention, control, and countermeasures

SSL	soil screening level
SSTL	site-specific target level
SVE	soil vapor extraction
SVOC	semivolatile organic compound
TC	toxicity characteristic
TCLP	toxicity-characteristic leaching procedure
TI	technical impracticability
TMB	trimethylbenzene
TOC	total organic carbon
TPH	total petroleum hydrocarbons
TRPH	total recoverable petroleum hydrocarbons
TVH	total volatile hydrocarbons
TVPH	total volatile petroleum hydrocarbons
TWA	time-weighted-average
UCL	upper confidence limit
US	United States
USGS	US Geological Survey
UST	underground storage tank
VOCs	volatile organic compounds

DEFINITIONS

Aerobe: bacteria that use oxygen as an electron acceptor.

Anabolism: The process whereby energy is used to build organic compounds such as enzymes and nucleic acids that are necessary for life functions. In essence, energy is derived from catabolism, stored in high-energy intermediate compounds such as adenosine triphosphate (ATP), guanosine triphosphate (GTP) and acetyl-coenzyme A, and used in anabolic reactions that allow a cell to grow.

Anaerobe: Organisms that do not require oxygen to live.

Area of Attainment: The area over which cleanup levels will be achieved in the ground water. It encompasses the area outside the boundary of any waste remaining in place and up to the boundary of the contaminant plume. Usually, the boundary of the waste is defined by the source control remedy. Note: this area is independent of property boundaries or potential receptors - it is the plume area which the ground water must be returned to beneficial use during the implementation of a remedy.

Anthropogenic: Man-made.

Autotrophs: Microorganisms that synthesize organic materials from carbon dioxide.

Catabolism: The process whereby energy is extracted from organic compounds by breaking them down into their component parts.

Coefficient of Variation: Sample standard deviation divided by the mean.

Cofactor: A small molecule required for the function of an enzyme.

Cometabolism: The process in which a compound is fortuitously degraded by an enzyme or cofactor produced during microbial metabolism of another compound.

Daughter Product: A compound that results directly from the biodegradation of another. For example *cis*-1,2-dichloroethene (*cis*-1,2-DCE) is commonly a daughter product of trichloroethene (TCE).

Dehydrohalogenation: Elimination of a hydrogen ion and a halide ion resulting in the formation of an alkene.

Diffusion: The process whereby molecules move from a region of higher concentration to a region of lower concentration as a result of Brownian motion.

Dihaloelimination: Reductive elimination of two halide substituents resulting in formation of an alkene.

Dispersivity: A property that quantifies mechanical dispersion in a medium.

Effective Porosity: The percentage of void volume that contributes to percolation; roughly equivalent to the specific yield.

Electron Acceptor: A compound capable of accepting electrons during oxidation-reduction reactions. Microorganisms obtain energy by transferring electrons from electron donors such as organic compounds (or sometimes reduced inorganic compounds such as sulfide) to an electron acceptor. Electron acceptors are compounds that are relatively oxidized and include oxygen, nitrate, iron (III), manganese (IV), sulfate, carbon dioxide, or in some cases the chlorinated aliphatic hydrocarbons such as perchloroethene (PCE), TCE, DCE, and vinyl chloride.

Electron Donor: A compound capable of supplying (giving up) electrons during oxidation-reduction reactions. Microorganisms obtain energy by transferring electrons from electron donors such as organic compounds (or sometimes reduced inorganic compounds such as sulfide) to an electron acceptor. Electron donors are compounds that are relatively reduced and include fuel hydrocarbons and native organic carbon.

Electrophile: A reactive species that accepts an electron pair.

Elimination: Reaction where two groups such as chlorine and hydrogen are lost from adjacent carbon atoms and a double bond is formed in their place.

Epoxidation: A reaction wherein an oxygen molecule is inserted in a carbon-carbon double bond and an epoxide is formed.

Facultative Anaerobes: microorganisms that use (and prefer) oxygen when it is available, but can also use alternate electron acceptors such as nitrate under anaerobic conditions when necessary.

Fermentation: Microbial metabolism in which a particular compound is used both as an electron donor and an electron acceptor resulting in the production of oxidized and reduced daughter products.

Heterotroph: Organism that uses organic carbon as an external energy source and as a carbon source.

Hydraulic Conductivity: The relative ability of a unit cube of soil, sediment, or rock to transmit water.

Hydraulic Head: The height above a datum plane of the surface of a column of water. In the groundwater environment, it is composed dominantly of elevation head and pressure head.

Hydraulic Gradient: The maximum change in head per unit distance.

Hydrogenolysis: A reductive reaction in which a carbon-halogen bond is broken, and hydrogen replaces the halogen substituent.

Hydroxylation: Addition of a hydroxyl group to a chlorinated aliphatic hydrocarbon.

Lithotroph: Organism that uses inorganic carbon such as carbon dioxide or bicarbonate as a carbon source and an external source of energy.

Mechanical Dispersion: A physical process of mixing along a flow path in an aquifer resulting from differences in path length and flow velocity. This is in contrast to mixing due to diffusion.

Metabolic Byproduct: A product of the reaction between an electron donor and an electron acceptor. Metabolic byproducts include volatile fatty acids, daughter products of chlorinated aliphatic hydrocarbons, methane, and chloride.

Monoxygenase: A microbial enzyme that catalyzes reactions in which one atom of the oxygen molecule is incorporated into a product and the other atom appears in water.

Nucleophile: A chemical reagent that reacts by forming covalent bonds with electronegative atoms and compounds.

Obligate Aerobe: Microorganisms that can use only oxygen as an electron acceptor. Thus, the presence of molecular oxygen is a requirement for these microbes.

Obligate Anaerobes: Microorganisms that grow only in the absence of oxygen; the presence of molecular oxygen either inhibits growth or kills the organism. For example, methanogens are very sensitive to oxygen and can live only under strictly anaerobic conditions. Sulfate reducers, on the other hand, can tolerate exposure to oxygen, but cannot grow in its presence (Chapelle, 1993).

Performance Evaluation Well: A ground-water monitoring well placed to monitor the effectiveness of the chosen remedial action.

Porosity: The ratio of void volume to total volume of a rock or sediment.

Respiration: The process of coupling oxidation of organic compounds with the reduction of inorganic compounds, such as oxygen, nitrate, iron (III), manganese (IV), and sulfate.

Solvolyis: A reaction in which the solvent serves as the nucleophile.

Table i: Contaminants with Federal Regulatory Standards Considered in this Document

Abbreviation	Chemical Abstracts Service (CAS) Name	CAS Number	Other Names	Molecular Formula
PCE	tetrachloroethene	127-18-4	perchloroethylene; tetrachloroethylene	C ₂ Cl ₄
TCE	trichloroethene	79-01-6	trichloroethylene	C ₂ HCl ₃
1,1-DCE	1,1-dichloroethene	75-35-4	1,1-dichloroethylene; vinylidene chloride	C ₂ H ₂ Cl ₂
trans-1,2-DCE	(E)-1,2-dichloroethene	156-60-5	trans-1,2-dichloroethene; trans-1,2-dichloroethylene	C ₂ H ₂ Cl ₂
cis-1,2-DCE		156-59-2	cis-1,2-dichloroethene; cis-1,2-dichloroethylene	C ₂ H ₂ Cl ₂
VC	chloroethene	75-01-4	vinyl chloride; chloroethylene	C ₂ H ₃ Cl
1,1,1-TCA	1,1,1-trichloroethane	71-55-6		C ₂ H ₃ Cl ₃
1,1,2-TCA	1,1,2-trichloroethane	79-00-5		C ₂ H ₃ Cl ₃
1,1-DCA	1,1-dichloroethane	75-34-3		C ₂ H ₄ Cl ₂
1,2-DCA	1,2-dichloroethane	107-06-02		C ₂ H ₄ Cl ₂
CA	chloroethane	75-00-3		C ₂ H ₅ Cl
CF	trichloromethane	67-66-3	chloroform	CHCl ₃
CT	tetrachloromethane	56-23-5	carbon tetrachloride	CCl ₄
Methylene Chloride	dichloromethane	75-09-2	methylene dichloride	CH ₂ Cl ₂
CB	chlorobenzene	108-90-7		C ₆ H ₅ Cl
1,2-DCB	1,2-dichlorobenzene	95-50-1	o-dichlorobenzene	C ₆ H ₄ Cl ₂
1,3-DCB	1,3-dichlorobenzene	541-73-1	m-dichlorobenzene	C ₆ H ₄ Cl ₂
1,4-DCB	1,4-dichlorobenzene	106-46-7	p-dichlorobenzene	C ₆ H ₄ Cl ₂
1,2,3-TCB	1,2,3-trichlorobenzene	87-61-6		C ₆ H ₃ Cl ₃
1,2,4-TCB	1,2,4-trichlorobenzene	120-82-1		C ₆ H ₃ Cl ₃
1,3,5-TCB	1,3,5-trichlorobenzene	108-70-3		C ₆ H ₃ Cl ₃
1,2,3,5-TECB	1,2,3,5-tetrachlorobenzene	634-90-2	1,2,3,5-TCB	C ₆ H ₂ Cl ₄
1,2,4,5-TECB	1,2,4,5-tetrachlorobenzene	95-94-3		C ₆ H ₂ Cl ₄
HCB	hexachlorobenzene	118-74-1		C ₆ Cl ₆
EDB	1,2-dibromoethane	106-93-4	ethylene dibromide; dibromoethane	C ₂ H ₄ Br ₂

SECTION 1

INTRODUCTION

Natural attenuation processes (biodegradation, dispersion, sorption, volatilization) affect the fate and transport of chlorinated solvents in all hydrologic systems. When these processes are shown to be capable of attaining site-specific remediation objectives in a time period that is reasonable compared to other alternatives, they may be selected alone or in combination with other more active remedies as the preferred remedial alternative. Monitored Natural Attenuation (MNA) is a term that refers specifically to the use of natural attenuation processes as part of overall site remediation. The United States Environmental Protection Agency (U.S. EPA) defines monitored natural attenuation as (OSWER Directive 9200.4-17, 1997):

The term “monitored natural attenuation,” as used in this Directive, refers to the reliance on natural attenuation processes (within the context of a carefully controlled and monitored clean-up approach) to achieve site-specific remedial objectives within a time frame that is reasonable compared to other methods. The “natural attenuation processes” that are at work in such a remediation approach include a variety of physical, chemical, or biological processes that, under favorable conditions, act without human intervention to reduce the mass, toxicity, mobility, volume, or concentration of contaminants in soil and ground water. These in-situ processes include, biodegradation, dispersion, dilution, sorption, volatilization, and chemical or biological stabilization, transformation, or destruction of contaminants.

Monitored natural attenuation is appropriate as a remedial approach only when it can be demonstrated capable of achieving a site’s remedial objectives within a time frame that is reasonable compared to that offered by other methods and where it meets the applicable remedy selection program for a particular OSWER program. EPA, therefore, expects that monitored natural attenuation typically will be used in conjunction with active remediation measures (e.g., source control), or as a follow-up to active remediation measures that have already been implemented.

The intent of this document is to present a technical protocol for data collection and analysis to evaluate monitored natural attenuation through biological processes for remediating ground water contaminated with mixtures of fuels and chlorinated aliphatic hydrocarbons. This document focuses on technical issues and is not intended to address policy considerations or specific regulatory or statutory requirements. In addition, this document does not provide comprehensive guidance on overall site characterization or long-term monitoring of MNA remedies. Users of this protocol should realize that different Federal and State remedial programs may have somewhat different remedial objectives. For example, the CERCLA and RCRA Corrective Action programs generally require that remedial actions: 1) prevent exposure to contaminated ground water, above acceptable risk levels; 2) minimize further migration of the plume; 3) minimize further migration of contaminants from source materials; and 4) restore the plume to cleanup levels appropriate for current or future beneficial uses, to the extent practicable. Achieving such objectives could often require that MNA be used in conjunction with other “active” remedial methods. For other cleanup programs, remedial objectives may be focused on preventing exposures above acceptable levels. Therefore, it is imperative that users of this document be aware of and understand the Federal and

State statutory and regulatory requirements, as well as policy considerations that apply to a specific site for which this protocol will be used to evaluate MNA as a remedial option. As a general practice (i.e., not just pertaining to this protocol), individuals responsible for evaluating remedial alternatives should interact with the overseeing regulatory agency to identify likely characterization and cleanup objectives for a particular site prior to investing significant resources. The policy framework within which MNA should be considered for Federal cleanup programs is described in the November 1997 EPA Directive titled, “Use of Monitored Natural Attenuation at Superfund, RCRA Corrective Action and Underground Storage Tank Sites” (Directive No. 9200.4-17).

This protocol is designed to evaluate the fate in ground water of chlorinated aliphatic hydrocarbons and/or fuel hydrocarbons. Because documentation of natural attenuation requires detailed site characterization, the data collected under this protocol can be used to compare the relative effectiveness of other remedial options and natural attenuation. This protocol should be used to evaluate whether MNA by itself or in conjunction with other remedial technologies is sufficient to achieve site-specific remedial objectives. In evaluating the appropriateness of MNA, the user of this protocol should consider both existing exposure pathways, as well as exposure pathways arising from potential future uses of the ground water.

This protocol is aimed at improving the characterization process for sites at which a remedy involving monitored natural attenuation is being considered. It contains methods and recommended strategies for completing the remedial investigation process. Emphasis is placed on developing a more complete understanding of the site through the conceptual site model process, early pathways analysis, and evaluation of remedial processes to include MNA. Understanding the contaminant flow field in the subsurface is essential for a technically justified evaluation of an MNA remedial option; therefore, use of this protocol is not appropriate for evaluating MNA at sites where the contaminant flow field cannot be determined with an acceptable degree of certainty (e.g., complex fractured bedrock, karst aquifers).

In practice, natural attenuation also is referred to by several other names, such as intrinsic remediation, intrinsic bioremediation, natural restoration, or passive bioremediation. The goal of any site characterization effort is to understand the fate and transport of the contaminants of concern over time in order to assess any current or potential threat to human health or the environment. Natural attenuation processes, such as biodegradation, can often be dominant factors in the fate and transport of contaminants. Thus, consideration and quantification of natural attenuation is essential to a more thorough understanding of contaminant fate and transport.

1.1 APPROPRIATE APPLICATION ON NATURAL ATTENUATION

The intended audience for this document includes Project Managers and their contractors, scientists, consultants, regulatory personnel, and others charged with remediating ground water contaminated with chlorinated aliphatic hydrocarbons or mixtures of fuel hydrocarbons and chlorinated aliphatic hydrocarbons. This protocol is intended to be used within the established regulatory framework appropriate for selection of a remedy at a particular hazardous waste site (e.g., the nine-criteria analysis used to evaluate remedial alternatives in the CERCLA remedy selection process). It is not the intent of this document to replace existing U.S. EPA or state-specific guidance on conducting remedial investigations.

The EPA does not consider monitored natural attenuation to be a default or presumptive remedy at any contaminated site (OSWER Directive 9200.4-17, 1997), as its applicability is highly variable from site to site. In order for MNA to be selected as a remedy, site-specific determinations

will always have to be made to ensure that natural attenuation is sufficiently protective of human health and the environment.

Natural attenuation in ground-water systems results from the integration of several subsurface attenuation mechanisms that are classified as either destructive or nondestructive. Biodegradation is the most important destructive attenuation mechanism, although abiotic destruction of some compounds does occur. Nondestructive attenuation mechanisms include sorption, dispersion, dilution from recharge, and volatilization. The natural attenuation of fuel hydrocarbons is described in the *Technical Protocol for Implementing Intrinsic Remediation with Long-Term Monitoring for Natural Attenuation of Fuel Contamination Dissolved in Groundwater*, published by the Air Force Center for Environmental Excellence (AFCEE) (Wiedemeier *et al.*, 1995d). This document differs from the technical protocol for intrinsic remediation of fuel hydrocarbons because it focuses on the individual processes of chlorinated aliphatic hydrocarbon biodegradation which are fundamentally different from the processes involved in the biodegradation of fuel hydrocarbons.

For example, biodegradation of fuel hydrocarbons, especially benzene, toluene, ethylbenzene, and xylenes (BTEX), is mainly limited by electron acceptor availability, and generally will proceed until all of the contaminants biochemically accessible to the microbes are destroyed. In the experience of the authors, there appears to be an adequate supply of electron acceptors in most, if not all, hydrogeologic environments. On the other hand, the more highly chlorinated solvents such as perchloroethene (PCE) and trichloroethene (TCE) typically are biodegraded under natural conditions via reductive dechlorination, a process that requires both electron acceptors (the chlorinated aliphatic hydrocarbons) and an adequate supply of electron donors. Electron donors include fuel hydrocarbons or other types of anthropogenic carbon (e.g., landfill leachate) or natural organic carbon. If the subsurface environment is depleted of electron donors before the chlorinated aliphatic hydrocarbons are removed, biological reductive dechlorination will cease, and natural attenuation may no longer be protective of human health and the environment. This is the most significant difference between the processes of fuel hydrocarbon and chlorinated aliphatic hydrocarbon biodegradation.

For this reason, it is more difficult to predict the long-term behavior of chlorinated aliphatic hydrocarbon plumes than fuel hydrocarbon plumes. Thus, it is important to have a good understanding of the important natural attenuation mechanisms. Data collection should include all pertinent parameters to evaluate the efficacy of natural attenuation. In addition to having a better understanding of the processes of advection, dispersion, dilution from recharge, and sorption, it is necessary to better quantify biodegradation. This requires an understanding of the interactions between chlorinated aliphatic hydrocarbons, anthropogenic or natural carbon, and inorganic electron acceptors at the site. Detailed site characterization is required to adequately document and understand these processes. The long-term monitoring strategy should consider the possibility that the behavior of a plume may change over time and monitor for the continued availability of a carbon source to support reductive dechlorination.

An understanding of the attenuation mechanisms is also important to characterizing exposure pathways. After ground water plumes come to steady state, sorption can no longer be an important attenuation mechanism. The most important mechanisms will be biotransformation, discharge through advective flow, and volatilization. As an example, Martin and Imbrigiotta (1994) calibrated a detailed transport and fate model to a release of pure TCE at Picatinny Arsenal, in New Jersey. The plume was at steady state or declining. Ten years after surface spills ceased, leaching of contaminants from subsurface DNAPLs and desorption from fine-grained layers were the only processes identified that continued to contribute TCE to ground water. Desorption of TCE occurred

at a rate of 15 to 85 mg/second. Anaerobic biotransformation consumed TCE at a rate of up to 30 mg/second, advective flow and discharge of TCE to surface water accounted for up to 2 mg/second, and volatilization of TCE accounted for 0.1 mg/second. In this case, recharge of uncontaminated water drove the plume below the water table, which minimized the opportunity for volatilization to the unsaturated zone. As a result, discharge to surface water was the only important exposure pathway. Volatilization will be more important at sites that do not have significant recharge to the water table aquifer, or that have NAPLs at the water table that contain chlorinated organic compounds.

Chlorinated solvents are released into the subsurface as either aqueous-phase or nonaqueous phase liquids. Typical solvent releases include nonaqueous phase relatively pure solvents that are more dense than water and aqueous rinseates. Additionally, a release may occur as a mixture of fuel hydrocarbons or sludges and chlorinated aliphatic hydrocarbons which, depending on the relative proportion of each compound group, may be more or less dense than water. If the NAPL is more dense than water, the material is referred to as a “dense nonaqueous-phase liquid,” or DNAPL. If the NAPL is less dense than water the material is referred to as a “light nonaqueous-phase liquid,” or LNAPL. Contaminant sources generally consist of chlorinated solvents present as mobile NAPL (NAPL occurring at sufficiently high saturations to drain under the influence of gravity into a well) and residual NAPL (NAPL occurring at immobile, residual saturations that are unable to drain into a well by gravity). In general, the greatest mass of contaminant is associated with these NAPL source areas, not with the aqueous phase.

When released at the surface, NAPLs move downward under the force of gravity and tend to follow preferential pathways such as along the surface of sloping fine-grained layers or through fractures in soil or rock. Large NAPL releases can extend laterally much farther from the release point than would otherwise be expected, and large DNAPL releases can sink to greater depths than expected by following preferential flow paths. Thus, the relative volume of the release and potential migration pathways should be considered when developing the conceptual model for the distribution of NAPL in the subsurface.

As water moves through NAPL areas (recharge in the vadose zone or ground water flow in an aquifer), the more soluble constituents partition into the water to generate a plume of dissolved contamination and the more volatile contaminants partition to the vapor phase. After surface releases have stopped, NAPLs remaining in the subsurface tend to “weather” over time as volatile and soluble components are depleted from NAPL surfaces. Even considering this “weathering” effect, subsurface NAPLS continue to be a source of contaminants to ground water for a very long time. For this reason, identification and delineation of subsurface zones containing residual or free-phase NAPL is an important aspect of the site conceptual model to be developed for evaluating MNA or other remediation methods.

Removal, treatment or containment of NAPLs may be necessary for MNA to be a viable remedial option or to decrease the time needed for natural processes to attain site-specific remediation objectives. In cases where removal of mobile NAPL is feasible, it is desirable to remove this source material and decrease the time required to reach cleanup objectives. Where removal or treatment of NAPL is not practical, source containment may be practicable and necessary for MNA to be a viable remedial option.

1.2 ADVANTAGES AND DISADVANTAGES

In comparison to engineered remediation technologies, remedies relying on monitored natural attenuation have the following advantages and disadvantages, as identified in OSWER Directive

9200.4-17, dated November 1997. (Note that this is an interim, not a final, Directive which was released by EPA for use. Readers are cautioned to consult the final version of this Directive when it becomes available.)

The **advantages** of monitored natural attenuation (MNA) remedies are:

- *As with any in situ process, generation of lesser volume of remediation wastes reduced potential for cross-media transfer of contaminants commonly associated with ex situ treatment, and reduced risk of human exposure to contaminated media;*
- *Less intrusion as few surface structures are required;*
- *Potential for application to all or part of a given site, depending on site conditions and cleanup objectives;*
- *Use in conjunction with, or as a follow-up to, other (active) remedial measures; and*
- *Lower overall remediation costs than those associated with active remediation.*

The **potential disadvantages** of monitored natural attenuation (MNA) include:

- *Longer time frames may be required to achieve remediation objectives, compared to active remediation;*
- *Site characterization may be more complex and costly;*
- *Toxicity of transformation products may exceed that of the parent compound;*
- *Long-term monitoring will generally be necessary;*
- *Institutional controls may be necessary to ensure long-term protectiveness;*
- *Potential exists for continued contamination migration, and/or cross-media transfer of contaminants;*
- *Hydrologic and geochemical conditions amenable to natural attenuation are likely to change over time and could result in renewed mobility of previously stabilized contaminants, adversely impacting remedial effectiveness; and*
- *More extensive education and outreach efforts may be required in order to gain public acceptance of monitored natural attenuation.*

At some sites the same geochemical conditions and processes that lead to biodegradation of chlorinated solvents and petroleum hydrocarbons can chemically transform naturally occurring manganese, arsenic and other metals in the aquifer matrix, producing forms of these metals that are more mobile and/or more toxic than the original materials. A comprehensive assessment of risk at a hazardous waste site should include sampling and analysis for these metals.

This document describes (1) those processes that bring about natural attenuation, (2) the site characterization activities that may be performed to conduct a full-scale evaluation of natural attenuation, (3) mathematical modeling of natural attenuation using analytical or numerical solute fate and transport models, and (4) the post-modeling activities that should be completed to ensure successful evaluation and verification of remediation by natural attenuation. The objective is to quantify and provide defensible data to evaluate natural attenuation at sites where naturally occurring subsurface attenuation processes are capable of reducing dissolved chlorinated aliphatic hydrocarbon and/or fuel hydrocarbon concentrations to acceptable levels. A comment made by a member of the regulatory community summarizes what is required to successfully implement natural attenuation:

A regulator looks for the data necessary to determine that a proposed treatment technology, if properly installed and operated, will reduce the contaminant concentrations in the soil and water to legally mandated limits. In this sense, the use of biological treatment systems calls for the same level of investigation,

demonstration of effectiveness, and monitoring as any conventional [remediation] system (National Research Council, 1993).

When the rate of natural attenuation of site contaminants is sufficient to attain site-specific remediation objectives in a time period that is reasonable compared to other alternatives, MNA may be an appropriate remedy for the site. This document presents a technical course of action that allows converging lines of evidence to be used to scientifically document the occurrence of natural attenuation and quantify the rate at which it is occurring. Such a “weight-of-evidence” approach will greatly increase the likelihood of successfully implementing natural attenuation at sites where natural processes are restoring the environmental quality of ground water.

1.3 LINES OF EVIDENCE

The OSWER Directive 9200.4-17 (1997) identifies three lines of evidence that can be used to estimate natural attenuation of chlorinated aliphatic hydrocarbons, including:

- (1) *Historical ground water and/or soil chemistry data that demonstrate a clear and meaningful trend of decreasing contaminant mass and/or concentration over time at appropriate monitoring or sampling points. (In the case of a ground water plume, decreasing concentrations should not be solely the result of plume migration. In the case of inorganic contaminants, the primary attenuating mechanism should also be understood.)*
- (2) *Hydrogeologic and geochemical data that can be used to demonstrate indirectly the type(s) of natural attenuation processes active at the site, and the rate at which such processes will reduce contaminant concentrations to required levels. For example, characterization data may be used to quantify the rates of contaminant sorption, dilution, or volatilization, or to demonstrate and quantify the rates of biological degradation processes occurring at the site.*
- (3) *Data from field or microcosm studies (conducted in or with actual contaminated site media) which directly demonstrate the occurrence of a particular natural attenuation process at the site and its ability to degrade the contaminants of concern (typically used to demonstrate biological degradation processes only).*

The OSWER Directive provides the following guidance on interpreting the lines of evidence:

Unless EPA or the implementing state agency determines that historical data (Number 1 above) are of sufficient quality and duration to support a decision to use monitored natural attenuation, EPA expects that data characterizing the nature and rates of natural attenuation processes at the site (Number 2 above) should be provided. Where the latter are also inadequate or inconclusive, data from microcosm studies (Number 3 above) may also be necessary. In general, more supporting information may be required to demonstrate the efficacy of monitored natural attenuation at those sites with contaminants which do not readily degrade through biological processes (e.g., most non-petroleum compounds, inorganics), at sites with contaminants that transform into more toxic and/or mobile forms than the parent contaminant, or at sites where monitoring has been performed for a relatively short period of time. The amount and type of information needed for such a demonstration will depend upon a number of site-specific factors, such as the size and nature of the contamination problem, the proximity of receptors and the potential risk to those receptors, and other physical characteristics of the environmental setting (e.g., hydrogeology, ground cover, or climatic conditions).

The first line of evidence does not prove that contaminants are being destroyed. Reduction in contaminant concentration could be the result of advection, dispersion, dilution from recharge, sorption, and volatilization (i.e., the majority of apparent contaminant loss could be due to dilution). However, this line of evidence is critical for determining if any exposure pathways exist for current or potential future receptors.

In order to evaluate remediation by natural attenuation at most sites, the investigator will have to determine whether contaminant mass is being destroyed. This is done using either, or both, of the second or third lines of evidence. The second line of evidence relies on chemical and physical data to show that contaminant mass is being destroyed, not just being diluted or sorbed to the aquifer matrix. For many contaminants, biodegradation is the most important process, but for certain contaminants nonbiological reactions are also important. The second line of evidence is divided into two components:

- Using chemical analytical data in mass balance calculations to show that decreases in contaminant and electron acceptor/donor concentrations can be directly correlated to increases in metabolic end products/daughter compounds. This evidence can be used to show that electron acceptor/donor concentrations in ground water are sufficient to facilitate degradation of dissolved contaminants. Solute fate and transport models can be used to aid mass balance calculations and to collate and present information on degradation.
- Using measured concentrations of contaminants and/or biologically recalcitrant tracers in conjunction with aquifer hydrogeologic parameters such as seepage velocity and dilution to show that a reduction in contaminant mass is occurring at the site and to calculate biodegradation rate constants.

The biodegradation rate constants are used in conjunction with the other fate and transport parameters to predict contaminant concentrations and to assess risk at downgradient performance evaluation wells and within the area of the dissolved plume.

Microcosm studies may be necessary to physically demonstrate that natural attenuation is occurring. Microcosm studies can also be used to show that indigenous biota are capable of degrading site contaminants at a particular rate. Microcosm studies **for the purpose of developing rate constants** should only be undertaken when they are the only means available to obtain biodegradation rate estimates. There are two important categories of sites where it is difficult or impossible to extract rate constants from concentrations of contaminants in monitoring wells in the field. In some sites, important segments of the flow path to receptors are not accessible to monitoring because of landscape features (such as lakes or rivers) or property boundaries that preclude access to a site for monitoring. In other sites that are influenced by tides, or the stage of major rivers, or ground water extraction wells, the ground water plume trajectory changes so rapidly that it must be described in a statistical manner. A “snapshot” round of sampling cannot be used to infer the plume velocity in calculations of the rate of attenuation.

1.4 SITE CHARACTERIZATION

The OSWER Directive 9200.4-17 (1997) describes EPA requirements for adequate site characterization.

Decisions to employ monitored natural attenuation as a remedy or remedy component should be thoroughly and adequately supported with site-specific characterization data and analysis. In general, the level of site characterization necessary to support a comprehensive evaluation of natural attenuation is more detailed than that needed to support active remediation. Site characterizations for

natural attenuation generally warrant a quantitative understanding of source mass; ground water flow; contaminant phase distribution and partitioning between soil, ground water, and soil gas; rates of biological and non-biological transformation; and an understanding of how all of these factors are likely to vary with time. This information is generally necessary since contaminant behavior is governed by dynamic processes which must be well understood before natural attenuation can be appropriately applied at a site. Demonstrating the efficacy of this remediation approach likely will require analytical or numerical simulation of complex attenuation processes. Such analyses, which are critical to demonstrate natural attenuation's ability to meet remedial action objectives, generally require a detailed conceptual site model as a foundation.

*A conceptual site model is a three-dimensional representation that conveys what is known or suspected about contamination sources, release mechanisms, and the transport and fate of those contaminants. The conceptual model provides the basis for assessing potential remedial technologies at the site. "Conceptual site model" is **not** synonymous with "computer model;" however, a computer model may be helpful for understanding and visualizing current site conditions or for predictive simulations of potential future conditions. Computer models, which simulate site processes mathematically, should in turn be based upon sound conceptual site models to provide meaningful information. Computer models typically require a lot of data, and the quality of the output from computer models is directly related to the quality of the input data. Because of the complexity of natural systems, models necessarily rely on simplifying assumptions that may or may not accurately represent the dynamics of the natural system.*

Site characterization should include collecting data to define (in three spatial dimensions over time) the nature and distribution of contamination sources as well as the extent of the ground water plume and its potential impacts on receptors. However, where monitored natural attenuation will be considered as a remedial approach, certain aspects of site characterization may require more detail or additional elements. For example, to assess the contributions of sorption, dilution, and dispersion to natural attenuation of contaminated ground water, a very detailed understanding of aquifer hydraulics, recharge and discharge areas and volumes, and chemical properties is required. Where biodegradation will be assessed, characterization also should include evaluation of the nutrients and electron donors and acceptors present in the ground water, the concentrations of co-metabolites and metabolic by-products, and perhaps specific analyses to identify the microbial populations present. The findings of these, and any other analyses pertinent to characterizing natural attenuation processes, should be incorporated into the conceptual model of contaminant fate and transport developed for the site.

Development of an adequate database during the iterative site characterization process is an important step in the documentation of natural attenuation. Site characterization should provide data on the location, nature, phase distribution, and extent of contaminant sources. Site characterization also should provide information on the location, extent, and concentrations of dissolved contamination; ground water geochemical data; geologic information on the type and distribution of subsurface materials; and hydrogeologic parameters such as hydraulic conductivity,

hydraulic gradients, and potential contaminant migration pathways to human or ecological receptor exposure points.

The data collected during site characterization can be used to simulate the fate and transport of contaminants in the subsurface. Such simulation allows prediction of the future extent and concentrations of the dissolved contaminant plume. Several types of models can be used to simulate dissolved contaminant transport and attenuation.

The natural attenuation modeling effort has five primary objectives:

- To evaluate whether MNA will be likely to attain site-specific remediation objectives in a time period that is reasonable compared to other alternatives;
- To predict the future extent and concentration of a dissolved contaminant plume by simulating the combined effects of contaminant loading, advection, dispersion, sorption, and biodegradation;
- To predict the most useful locations for ground-water monitoring;
- To assess the potential for downgradient receptors to be exposed to contaminant concentrations that exceed regulatory or risk-based levels intended to be protective of human health and the environment; and
- To provide technical support for remedial options using MNA during screening and detailed evaluation of remedial alternatives in a CERCLA Feasibility Study or RCRA Corrective Measures Study.

Upon completion of the fate and transport modeling effort, model predictions can be used to evaluate whether MNA is a viable remedial alternative for a given site. If the transport and fate models predict that natural attenuation is sufficient to attain site-specific remediation objectives and will be protective of human health and the environment, natural attenuation may be an appropriate remedy for the site. Model assumptions and results should be verified by data obtained from site characterization. If model assumptions and results are not verified by site data, MNA is not likely to be a viable option and should not be proposed as the remedy.

1.5 MONITORING

The Monitoring Program OSWER Directive on Monitored Natural Attenuation (9200.4-17) describes EPA expectations for performance monitoring.

Performance monitoring to evaluate remedy effectiveness and to ensure protection of human health and the environment is a critical element of all response actions. Performance monitoring is of even greater importance for monitored natural attenuation than for other types of remedies due to the longer remediation time frames, potential for ongoing contaminant migration, and other uncertainties associated with using monitored natural attenuation. This emphasis is underscored by EPA's reference to "monitored natural attenuation".

The monitoring program developed for each site should specify the location, frequency, and type of samples and measurements necessary to evaluate remedy performance as well as define the anticipated performance objectives of the remedy. In addition, all monitoring programs should be designed to accomplish the following:

- *Demonstrate that natural attenuation is occurring according to expectations;*
- *Identify any potentially toxic transformation products resulting from biodegradation;*
- *Determine if a plume is expanding (either downgradient, laterally or vertically);*
- *Ensure no impact to downgradient receptors;*
- *Detect new releases of contaminants to the environment that could impact the*

- effectiveness of the natural attenuation remedy;*
- *Demonstrate the efficacy of institutional controls that were put in place to protect potential receptors;*
 - *Detect changes in environmental conditions (e.g., hydrogeologic, geochemical, microbiological, or other changes) that may reduce the efficacy of any of the natural attenuation processes; and*
 - *Verify attainment of cleanup objectives.*

Detection of changes will depend on the proper siting and construction of monitoring wells/points. Although the siting of monitoring wells is a concern for any remediation technology, it is of even greater concern with monitored natural attenuation because of the lack of engineering controls to control contaminant migration.

***Performance monitoring should continue as long as contamination remains above required cleanup levels.** Typically, monitoring is continued for a specified period (e.g., one to three years) after cleanup levels have been achieved to ensure that concentration levels are stable and remain below target levels. The institutional and financial mechanisms for maintaining the monitoring program should be clearly established in the remedy decision or other site documents, as appropriate.*

Natural attenuation is achieved when naturally occurring attenuation mechanisms, such as biodegradation, bring about a reduction in the total mass, toxicity, mobility, volume, or concentration of a contaminant dissolved in ground water. In some cases, natural attenuation processes will be capable of attaining site-specific remediation objectives in a time period that is reasonable compared to other alternatives. However, at this time, the authors are not aware of any sites where natural attenuation alone has succeeded in restoring ground water contaminated with chlorinated aliphatic hydrocarbons to drinking water quality over the entire plume.

The material presented here was prepared through the joint effort between the Bioremediation Research Team at the Subsurface Protection and Remediation Division of U.S. EPA's National Risk Management Research Laboratory (NRMRL) in Ada, Oklahoma, and the U.S. Air Force Center for Environmental Excellence, Technology Transfer Division, Brooks Air Force Base, Texas, and Parsons Engineering Science, Inc. (Parsons ES). It is designed to facilitate proper evaluation of remedial alternatives including natural attenuation at large chlorinated aliphatic hydrocarbon-contaminated sites.

This information is the most current available at the time of this writing. The scientific knowledge and experience with natural attenuation of chlorinated solvents is growing rapidly and the authors expect that the process for evaluating natural attenuation of chlorinated solvents will continue to evolve.

This document contains three sections, including this introduction. Section 2 presents the protocol to be used to obtain scientific data to evaluate the natural attenuation option. Section 3 presents the references used in preparing this document. Appendix A describes the collection of site characterization data necessary to evaluate natural attenuation, and provides soil and ground-water sampling procedures and analytical protocols. Appendix B provides an in-depth discussion of the destructive and nondestructive mechanisms of natural attenuation. Appendix C covers data interpretation and pre-modeling calculations.

SECTION 2

PROTOCOL FOR EVALUATING NATURAL ATTENUATION

The primary objective of the natural attenuation investigation is to determine whether natural processes will be capable of attaining site-specific remediation objectives in a time period that is reasonable compared to other alternatives. Further, natural attenuation should be evaluated to determine if it can meet all appropriate Federal and State remediation objectives for a given site. This requires that projections of the potential extent of the contaminant plume in time and space be made. These projections should be based on historic variations in contaminant concentration, and the current extent and concentrations of contaminants in the plume in conjunction with measured rates of contaminant attenuation. Because of the inherent uncertainty associated with such predictions, it is the responsibility of the proponent of monitored natural attenuation to provide sufficient evidence to demonstrate that the mechanisms of natural attenuation will meet the remediation objectives appropriate for the site. This can be facilitated by using conservative parameters in solute fate and transport models and numerous sensitivity analyses in order to better evaluate plausible contaminant migration scenarios. When possible, both historical data and modeling should be used to provide information that collectively and consistently confirms the natural reduction and removal of the dissolved contaminant plume.

Figure 2.1 outlines the steps involved in a natural attenuation demonstration and shows the important regulatory decision points for implementing natural attenuation. For example, a Superfund Feasibility Study is a two-step process that involves initial screening of potential remedial alternatives followed by more detailed evaluation of alternatives that pass the screening step. A similar process is followed in a RCRA Corrective Measures Study and for sites regulated by State remediation programs. The key steps for evaluating natural attenuation are outlined in Figure 2.1 and include:

- 1) Review available site data and develop a preliminary conceptual model. Determine if receptor pathways have already been completed. Respond as appropriate.
- 2) If sufficient existing data of appropriate quality exist, apply the screening process described in Section 2.2 to assess the potential for natural attenuation.
- 3) If preliminary site data suggest natural attenuation is potentially appropriate, perform additional site characterization to further evaluate natural attenuation. If all the recommended screening parameters listed in Section 2.2 have been collected and the screening processes suggest that natural attenuation is not appropriate based on the potential for natural attenuation, evaluate whether other processes can meet the cleanup objectives for the site (e.g., abiotic degradation or transformation, volatilization, or sorption) or select a remedial option other than MNA.
- 4) Refine conceptual model based on site characterization data, complete pre-modeling calculations, and document indicators of natural attenuation.
- 5) Simulate, if necessary, natural attenuation using analytical or numerical solute fate and transport models that allow incorporation of a biodegradation term.
- 6) Identify potential receptors and exposure points and conduct an exposure pathways analysis.
- 7) Evaluate the need for supplemental source control measures. Additional source control may allow MNA to be a viable remedial option or decrease the time needed for natural processes to attain remedial objectives.

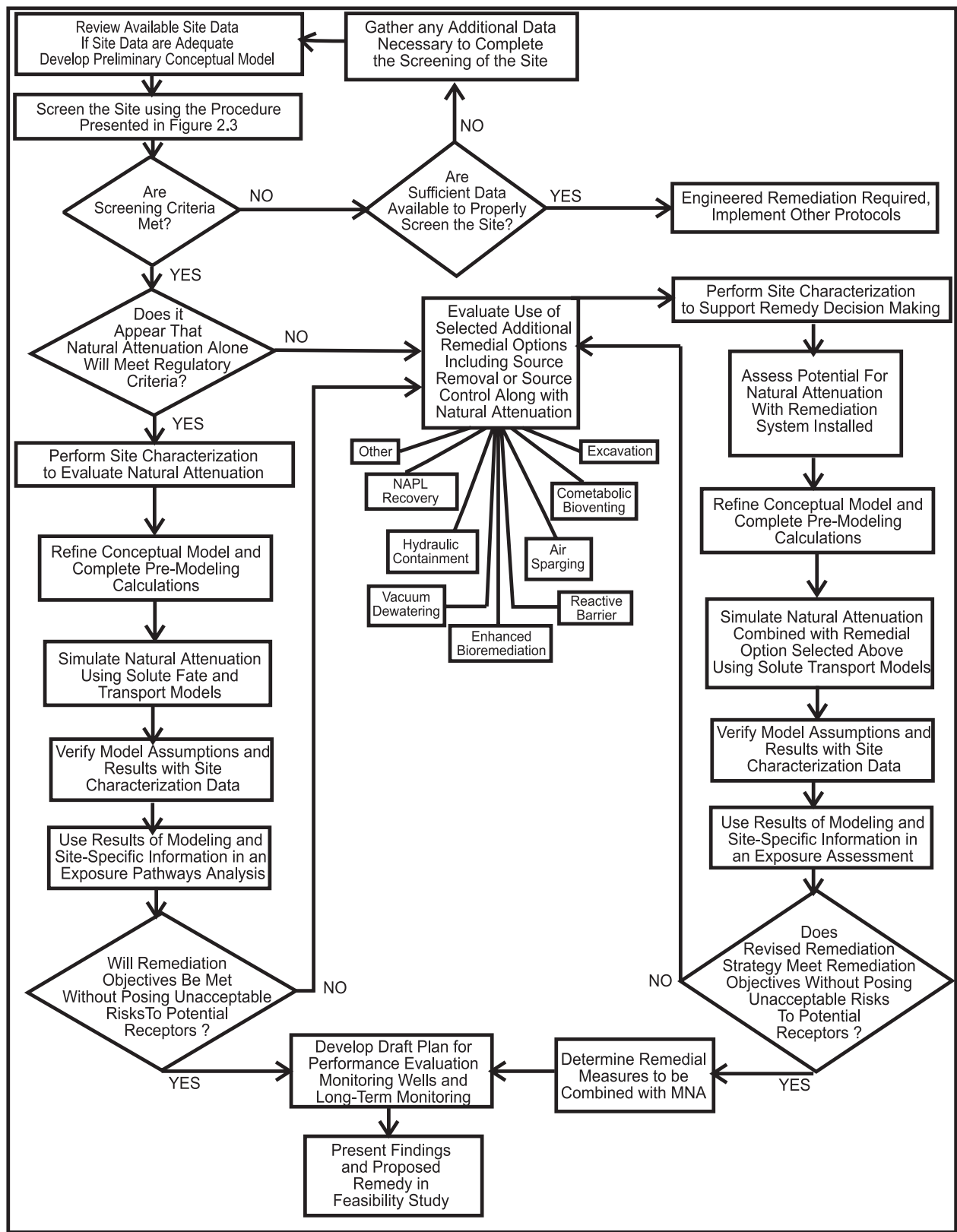

Figure 2.1 Natural attenuation of chlorinated solvents flow chart.

- 8) Prepare a long-term monitoring and verification plan for the selected alternative. In some cases, this includes monitored natural attenuation alone, or in other cases in concert with supplemental remediation systems.
- 9) Present findings of natural attenuation studies in an appropriate remedy selection document, such as a CERCLA Feasibility or RCRA Corrective Measures Study. The appropriate regulatory agencies should be consulted early in the remedy selection process to clarify the remedial objectives that are appropriate for the site and any other requirements that the remedy will be expected to meet. However, it should be noted that remedy requirements are not finalized until a decision is signed, such as a CERCLA Record of Decision or a RCRA Statement of Basis.

The following sections describe each of these steps in more detail.

2.1 REVIEW AVAILABLE SITE DATA AND DEVELOP PRELIMINARY CONCEPTUAL MODEL

The first step in the natural attenuation investigation is to review available site-specific data. Once this is done, it is possible to use the initial site screening processes presented in Section 2.2 to determine if natural attenuation is a viable remedial option. A thorough review of these data also allows development of a preliminary conceptual model. The preliminary conceptual model will help identify any shortcomings in the data and will facilitate placement of additional data collection points in the most scientifically advantageous and cost-effective manner possible.

The following site information should be obtained during the review of available data. Information that is not available for this initial review should be collected during subsequent site investigations when refining the site conceptual model, as described in Section 2.3.

- Nature, extent, and magnitude of contamination:
 - Nature and history of the contaminant release:
 - Catastrophic or gradual release of NAPL ?
 - More than one source area possible or present ?
 - Divergent or coalescing plumes ?
 - Three-dimensional distribution of dissolved contaminants and mobile and residual NAPLs. Often high concentrations of chlorinated solvents in ground water are the result of landfill leachates, rinse waters, or ruptures of water conveyance pipes. For LNAPLs the distribution of mobile and residual NAPL will be used to define the dissolved plume source area. For DNAPLs the distribution of the dissolved plume concentrations, in addition to any DNAPL will be used to define the plume source area.
 - Ground water and soil chemical data.
 - Historical water quality data showing variations in contaminant concentrations both vertically and horizontally.
 - Chemical and physical characteristics of the contaminants.
 - Potential for biodegradation of the contaminants.
 - Potential for natural attenuation to increase toxicity and/or mobility of natural occurring metals.
- Geologic and hydrogeologic data in three dimensions (If these data are not available, they should be collected for the natural attenuation demonstration and for any other remedial investigation or feasibility study):
 - Lithology and stratigraphic relationships.
 - Grain-size distribution (gravels vs. sand vs. silt vs. clay).

- Aquifer hydraulic conductivity (vertical and horizontal, effectiveness of aquitards, calculation of vertical gradients).
- Ground-water flow gradients and potentiometric or water table surface maps (over several seasons, if possible).
- Preferential flow paths.
- Interactions between ground water and surface water and rates of infiltration/recharge.
- Locations of potential receptor exposure points:
 - Ground water production and supply wells, and areas that can be deemed a potential source of drinking water.
 - Downgradient and crossgradient discharge points including any discharges to surface waters or other ecosystems.
 - Vapor discharge to basements and other confined spaces.

In some cases, site-specific data are limited. If this is the case, all future site characterization activities should include collecting the data necessary to screen the site for the use of monitored natural attenuation as a potential site remedy. Much of the data required to evaluate natural attenuation can be used to design and evaluate other remedial measures.

Available site characterization data should be used to develop a conceptual model for the site. This conceptual model is a three-dimensional representation of the source area as a NAPL or region of highly contaminated ground water, of the surrounding uncontaminated area, of ground water flow properties, and of the solute transport system based on available geological, biological, geochemical, hydrological, climatological, and analytical data for the site. Data on the contaminant levels and aquifer characteristics should be obtained from wells and boreholes which will provide a clear three-dimensional picture of the hydrologic and geochemical characteristics of the site. High concentrations of dissolved contaminants can be the result of leachates, rinse waters and rupture of water conveyance lines, and are not necessarily associated with NAPLs.

This type of conceptual model differs from the conceptual site models commonly used by risk assessors that qualitatively consider the location of contaminant sources, release mechanisms, transport pathways, exposure points, and receptors. However, the conceptual model of the ground water system facilitates identification of these risk-assessment elements for the exposure pathways analysis. After development, the conceptual model can be used to help determine optimal placement of additional data collection points, as necessary, to aid in the natural attenuation investigation and to develop the solute fate and transport model. Contracting and management controls must be flexible enough to allow for the potential for revisions to the conceptual model and thus the data collection effort.

Successful conceptual model development involves:

- Definition of the problem to be solved (generally the three dimensional nature, magnitude, and extent of existing and future contamination).
- Identification of the core or cores of the plume in three dimensions. The core or cores contain the highest concentration of contaminants.
- Integration and presentation of available data, including:
 - Local geologic and topographic maps,
 - Geologic data,
 - Hydraulic data,
 - Biological data,
 - Geochemical data, and
 - Contaminant concentration and distribution data.

- Determination of additional data requirements, including:
 - Vertical profiling locations, boring locations and monitoring well spacing in three dimensions,
 - A sampling and analysis plan (SAP), and
 - Any data requirements listed in Section 2.1 that have not been adequately addressed.

Table 2.1 contains the recommended soil and ground water analytical methods for evaluating the potential for natural attenuation of chlorinated aliphatic hydrocarbons and/or fuel hydrocarbons. Any plan to collect additional ground water and soil quality data should include the analytes listed in this table. Table 2.2 lists the availability of these analyses and the recommended data quality requirements. Since required procedures for field sampling, analytical methods and data quality objectives vary somewhat among regulatory programs, the methods to be used at a particular site should be developed in collaboration with the appropriate regulatory agencies. There are many documents which may aid in developing data quality objectives (e.g., U.S. EPA Order 5360.1 and U.S. EPA QA/G-4 Guidance for the Data Quality Objectives Process).

2.2 INITIAL SITE SCREENING

After reviewing available site data and developing a preliminary conceptual model, an assessment of the potential for natural attenuation must be made. As stated previously, existing data can be useful to determine if natural attenuation is capable of attaining site-specific remediation objectives in a time period that is reasonable compared to other alternatives. This is achieved by first determining whether the plume is currently stable or migrating and the future extent of the plume based on (1) contaminant properties, including volatility, sorptive properties, and biodegradability; (2) aquifer properties, including hydraulic gradient, hydraulic conductivity, porosity and concentrations of native organic material in the sediment (TOC), and (3) the location of the plume and contaminant source relative to potential receptor exposure points (i.e., the distance between the leading edge of the plume and the potential receptor exposure points). These parameters (estimated or actual) are used in this section to make a preliminary assessment of the effectiveness of natural attenuation in reducing contaminant concentrations.

If, after completing the steps outlined in this section, it appears that natural attenuation will be a significant factor in contaminant removal and a viable remedial alternative, detailed site characterization activities that will allow evaluation of this remedial option should be performed. If exposure pathways have already been completed and contaminant concentrations exceed protective levels, or if such completion is likely, an engineered remedy is needed to prevent such exposures and should be implemented as an early action. For this case, MNA may still be appropriate to attain long-term remediation objectives for the site. Even so, the collection of data to evaluate natural attenuation can be integrated into a comprehensive remedial strategy and may help reduce the cost and duration of engineered remedial measures such as intensive source removal operations or pump-and-treat technologies.

2.2.1 Overview of Chlorinated Aliphatic Hydrocarbon Biodegradation

Because biodegradation is usually the most important destructive process acting to reduce contaminant concentrations in ground water, an accurate estimate of the potential for natural biodegradation is important to consider when determining whether ground water contamination presents a substantial threat to human health and the environment. This information also will be useful when selecting the remedial alternative that will be most cost effective at eliminating or abating these threats should natural attenuation alone not prove to be sufficient.

Table 2.1 Soil, Soil Gas, and Ground-water Analytical Methods to Evaluate the Potential for Natural Attenuation of Chlorinated Solvents or Fuel Hydrocarbons in Ground Water. Analyses other than those listed in this table may be required for regulatory compliance.

Matrix	Analysis	Method/Reference	Comments	Data Use	Recommended Frequency of Analysis	Sample Volume, Sample Container, Sample Preservation	Field or Fixed-Base Laboratory
Soil	Aromatic and Chlorinated hydrocarbons (benzene, toluene, ethylbenzene, and xylene [BTEX]; Chlorinated Compounds	SW8260A		Data are used to determine the extent of soil contamination, the contamination mass present, and the potential for source removal.	Each soil sampling round	Sample volume approximately 100 ml; subsample and extract in the field using methanol or appropriate solvent; cool to 4°C.	Fixed-base
Soil	Biologically Available Iron (III)	Under development	HCl extraction followed by quantification of released iron (III)	Optional method that should be used when fuel hydrocarbons or vinyl chloride are present in the ground water to predict the possible extent of removal of fuel hydrocarbons and vinyl chloride via iron reduction.	One round of sampling in five borings, five cores from each boring	Minimum 1 inch diameter core samples collected into plastic liner. Cap and prevent aeration.	Laboratory
Soil	Total organic carbon (TOC)	SW9060 modified for soil samples	Procedure must be accurate over the range of 0.1 to 5 percent TOC	The rate of migration of petroleum contaminants in ground water is dependent upon the amount of TOC in the aquifer matrix.	At initial sampling	Collect 100 g of soil in a glass container with Teflon-lined cap; cool to 4°C.	Fixed-base
Soil Gas	Fuel and Chlorinated VOCs	EPA Method TO-14		Useful for determining chlorinated and BTEX compounds in soil	At initial sampling	1-liter Summa Canister	Fixed-base
Soil Gas	Methane, Oxygen, Carbon dioxide	Field Soil Gas Analyzer		Useful for determining bioactivity in vadose zone.	At initial sampling and respiration testing	3-liters in a Tedlar bag, bags are reusable for analysis of methane, oxygen, or carbon dioxide.	Field

Table 2.1 (Continued)

Matrix	Analysis	Method/Reference	Comments	Data Use	Recommended Frequency of Analysis	Sample Volume, Sample Container, Sample Preservation	Field or Fixed-Base Laboratory
Water	Alkalinity	Hach Alkalinity test kit model AL AP MG-L	Phenolphthalein method	General water quality parameter used (1) as a marker to verify that all site samples are obtained from the same ground-water system and (2) to measure the buffering capacity of ground water.	Each sampling round	Collect 100 mL of water in glass container.	Field
Water	Aromatic and chlorinated hydrocarbons (BTEX, trimethylbenzene isomers, chlorinated compounds)	SW8260A	Analysis may be extended to higher molecular weight alkyl benzenes	Method of analysis for BTEX and chlorinated solvents/byproducts, which are the primary target analytes for monitoring natural attenuation; method can be extended to higher molecular weight alkyl benzenes; trimethylbenzenes are used to monitor plume dilution if degradation is primarily anaerobic.	Each sampling round	Collect water samples in a 40 mL VOA vial; cool to 4°C; add hydrochloric acid to pH 2.	Fixed-base
Water	Arsenic	EPA 200.7 or EPA 200.9		To determine if anaerobic biological activity is solubilizing arsenic from the aquifer matrix material.	One round of sampling	Collect 100 ml in a glass or plastic container that is rinsed in the field with the ground water to be sampled. Unfiltered samples obtained using low flow sampling methods are preferred for analysis of dissolved metals. Adjust pH to 2 with nitric acid. Do not insert pH paper or an electrode into the sample.	Laboratory
Water	Chloride (optional, see data use)	Hach Chloride test kit model 8-P	Silver nitrate titration	As above, and to guide selection of additional data points in real time while in the field.	Each sampling round	Collect 100 mL of water in a glass container.	Field

Table 2.1 (Continued)

Matrix	Analysis	Method/Reference	Comments	Data Use	Recommended Frequency of Analysis	Sample Volume, Sample Container, Sample Preservation	Field or Fixed-Base Laboratory
Water	Chloride	Mercuric nitrate titration A4500-Cl ⁻ C	Ion chromatography (IC) method E300 or method SW9050 may also be used	General water quality parameter used as a marker to verify that site samples are obtained from the same ground-water system. Final product of chlorinated solvent reduction.	Each sampling round	Collect 250 mL of water in a glass container.	Fixed-base
Water	Chloride (optional, see data use)	Hach Chloride test kit model 8-P	Silver nitrate titration	As above, and to guide selection of additional data points in real time while in the field.	Each sampling round	Collect 100 mL of water in a glass container.	Field
Water	Conductivity	E120.1/SW9050, direct reading meter		General water quality parameter used as a marker to verify that site samples are obtained from the same ground-water system.	Each sampling round	Collect 100 to 250 mL of water in a glass or plastic container.	Field
Water	Iron (II) (Fe ⁺²)	Colorimetric Hach Method # 8146	Filter if turbid.	May indicate an anaerobic degradation process due to depletion of oxygen, nitrate, and manganese.	Each sampling round	Collect from a flow-through or over-flow cell / analyze at the well head.	Field
Water	Hydrogen (H ₂)	Equilibration with gas in the field. Determined with a reducing gas detector.	Optional specialized analysis	Determined terminal electron accepting process. Predicts the possibility for reductive dechlorination.	One round of sampling on selected wells.	Sampled at well head requires the production of 300 mL per minute of water for 30 minutes.	Field
Water	Manganese	EPA 200.7 or EPA 200.9		To determine if anaerobic biological activity is solubilizing manganese from the aquifer matrix material.	One round of sampling	Collect 100 ml in a glass or plastic container that is rinsed in the field with the ground water to be sampled. Unfiltered samples obtained using low flow sampling methods are preferred for analysis of dissolved metals. Adjust pH to 2 with nitric acid. Do not insert pH paper or an electrode into the sample.	Laboratory

Table 2.1 (Continued)

Matrix	Analysis	Method/Reference	Comments	Data Use	Recommended Frequency of Analysis	Sample Volume, Sample Container, Sample Preservation	Field or Fixed-Base Laboratory
Water	Methane, ethane, and ethene	Kampbell <i>et al.</i> , 1989 and 1998 or SW3810 Modified	Method published by researchers at the U.S. Environmental Protection Agency. Limited to few commercial labs.	The presence of CH ₄ suggests BTEX degradation via methanogenesis. Ethane and ethene data are used where chlorinated solvents are suspected of undergoing biological transformation.	Each sampling round	Collect water samples in 50 mL glass serum bottles with gray butyl /Teflon-faced septa and crimp caps; add H ₂ SO ₄ to pH less than 2, cool to 4°C.	Fixed-base
Water	Nitrate	IC method E300		Substrate for microbial respiration if oxygen is depleted.	Each sampling round	Collect up to 40 mL of water in a glass or plastic container; add H ₂ SO ₄ to pH less than 2, cool to 4°C.	Fixed-base
Water	Oxidation-reduction potential	A2580B	Measurements made with electrodes; results are displayed on a meter; protect samples from exposure to oxygen. Report results against a silver/silver chloride reference electrode. (Eh) is calculated by adding a correction factor specific to the electrode used.	The ORP of ground water influences and is influenced by the nature of the biologically mediated degradation of contaminants; the ORP (expressed as Eh) of ground water may range from more than 800 mV to less than -400 mV.	Each sampling round	Measure in a flow through cell or an over-flowing container filled from the bottom to prevent exposure of the ground water to the atmosphere.	Field
Water	Oxygen	Dissolved oxygen meter calibrated between each well according to the supplier's specifications	Refer to method A4500 for a comparable laboratory procedure.	The oxygen concentration is a data input to the Bioplume model; concentrations less than 1 mg/L generally indicate an anaerobic pathway.	Each sampling round	Measure dissolved oxygen on site using a flow-through cell or over-flow cell.	Field
Water	pH	Field probe with direct reading meter calibrated in the field according to the supplier's specifications.	Field	Aerobic and anaerobic biological processes are pH-sensitive.	Each sampling round	Measure dissolved oxygen on site using a flow-through cell or over-flow cell.	Field

Table 2.1 (Continued)

Matrix	Analysis	Method/Reference	Comments	Data Use	Recommended Frequency of Analysis	Sample Volume, Sample Container, Sample Preservation	Field or Fixed-Base Laboratory
Water	Sulfate (SO ₄ ⁻²)	IC method E300	If this method is used for sulfate analysis, do not use the field method.	Substrate for anaerobic microbial respiration.	Each sampling round	Collect up to 40 mL of water in a glass or plastic container; cool to 4°C.	Fixed-base
Water	Sulfate (SO ₄ ⁻²)	Hach method # 8051	Colorimetric, if this method is used for sulfate analysis, do not use the fixed-base laboratory method.	Same as above.	Each sampling round	Collect up to 40 mL of water in a glass or plastic container; cool to 4°C.	Field
Water	Temperature	Field probe with direct reading meter.	Field only	To determine if a well is adequately purged for sampling.	Each sampling round	Read from oxygen meter.	Field
Water	Total Organic Carbon also called DOC	SW9060	Laboratory	Used to classify plume and to determine if reductive dechlorination is possible in the absence of anthropogenic carbon.	Each sampling round	Measure using a flow-through cell or overflow cell.	Laboratory

NOTES:

1. "Hach" refers to the Hach Company catalog, 1990.
2. "A" refers to *Standard Methods for the Examination of Water and Wastewater*, 18th edition, 1992.
3. "E" refers to *Methods for Chemical Analysis of Water and Wastes*, U.S. EPA, 1983.
4. "SW" refers to the *Test Methods for Evaluating Solid Waste, Physical, and Chemical Methods*, SW-846, U.S. EPA, 3rd edition, 1986.

Table 2.2 Objectives for Sensitivity and Precision to Implement the Natural Attenuation Protocol. Analyses other than those listed in this table may be required for regulatory compliance.

Matrix	Analysis	Method/Reference	Minimum Limit of Quantification	Precision	Availability	Potential Data Quality Problems
Soil	Aromatic and chlorinated hydrocarbons (benzene, toluene, ethylbenzene, and xylene [BTEX]; chlorinated compounds)	SW8260A	1 mg/Kg	Coefficient of Variation of 20 percent.	Common laboratory analysis.	Volatiles lost during shipment to laboratory; prefer extraction in the field.
Soil	Biologically Available Iron (III)	Under development	50 mg/Kg	Coefficient of Variation of 40 percent.	Specialized laboratory analysis.	Sample must not be allowed to oxidize.
Soil	Total organic carbon (TOC)	SW9060 modified for soil samples	0.1 percent	Coefficient of Variation of 20 percent.	Common laboratory analysis.	Samples must be collected from contaminant-transporting (i.e., transmissive) intervals.
Soil Gas	Fuel and Chlorinated VOCs	EPA Method TO-14	1 ppm (volume/volume)	Coefficient of Variation of 20 percent.	Common laboratory analysis.	Potential for atmospheric dilution during sampling.
Soil Gas	Methane, O ₂ , CO ₂	Field Soil Gas Analyzer	1 percent (volume/volume)	Coefficient of Variation of 20 percent.	Readily available field instrument.	Instrument must be properly calibrated.
Water	Alkalinity	Hach alkalinity test kit model AL AP MG-L	50 mg/L	Standard deviation of 20 mg/L.	Common field analysis.	Analyze sample within 1 hour of collection.
Water	Aromatic and chlorinated hydrocarbons (BTEX, trimethylbenzene isomers, chlorinated compounds)	SW8260A	MCLs	Coefficient of Variation of 10 percent.	Common laboratory analysis.	Volatilization during shipment and biodegradation due to improper preservation.
Water	Chloride	IC method E300	1 mg/L	Coefficient of Variation of 20 percent.	Common laboratory analysis.	----
Water	Chloride (optional, see data use)	Hach Chloride test kit model 8-P	1 mg/L	Coefficient of Variation of 20 percent.	Common field analysis.	Possible interference from turbidity.
Water	Conductivity	E120.1/SW9050, direct reading meter	50 μS/cm ²	Standard deviation of 50 μS/cm ² .	Common field probe.	Improperly calibrated instrument.

Table 2.2 (Continued)

Matrix	Analysis	Method/Reference	Minimum Limit of Quantification	Precision	Availability	Potential Data Quality Problems
Water	Hydrogen (H ₂) ^{u/}	See Appendix A	0.1 nM	Standard deviation of 0.1nM.	Specialized field analysis.	Numerous, see Appendix A.
Water	Iron (II) (Fe ²⁺) XX	Colorimetric Hach Method # 8146	0.5 mg/L	Coefficient of Variation of 20 percent.	Common field analysis.	Possible interference from turbidity (must filter if turbid). Keep out of sunlight and analyze within minutes of collection.
Water	Major Cations	SW6010	1 mg/L	Coefficient of Variation of 20 percent.	Common laboratory analysis.	Possible colloidal interferences.
Water	Methane, ethane, and ethene	Kampbell <i>et al.</i> , 1989 or SW3810 Modified	1 µg/L	Coefficient of Variation of 20 percent.	Specialized laboratory analysis.	Sample must be preserved against biodegradation and collected without headspace (to minimize volatilization).
Water	Nitrate	IC method E300	0.1 mg/L	Standard deviation of 0.1 mg/L	Common laboratory analysis.	Must be preserved.
Water	Oxidation-reduction potential (ORP)	A2580B	plus or minus 300 mV	plus or minus 50 mV.	Common field probe.	Improperly calibrated electrodes or introduction of atmospheric oxygen during sampling.
Water	Oxygen	Dissolved oxygen meter	0.2 mg/L	Standard deviation of 0.2 mg/L.	Common field instrument.	Improperly calibrated electrodes or bubbles behind the membrane or a fouled membrane or introduction of atmospheric oxygen during sampling.
Water	Sulfate (SO ₄ ²⁻)	IC method E300	5 mg/L	Coefficient of Variation of 20 percent.	Common laboratory.	Fixed-base.
Water	Sulfate (SO ₄ ²⁻) XX	Hach method # 8051	5 mg/L	Coefficient of Variation of 20 percent.	Common field analysis.	Possible interference from turbidity (must filter if turbid). Keep sample cool.
Water	pH	Field probe with direct reading meter.	0.1 standard units	0.1 standard units.	Common field meter.	Improperly calibrated instrument; time sensitive.
Water	Temperature	Field probe with direct reading meter.	0 degrees Celsius	Standard deviation of 1 degrees Celsius.	Common field probe.	Improperly calibrated instrument; time sensitive.
Water	Total Organic Carbon	SW9060	0.1 mg/L	Coefficient of Variation of 20 percent.	Common laboratory analysis.	

Notes:

** Filter if turbidity gives a response from the photometer before addition of the reagents that is as large or larger than the specified minimum quantification limit.

Over the past two decades, numerous laboratory and field studies have demonstrated that subsurface microorganisms can degrade a variety of chlorinated solvents (e.g., Bouwer *et al.*, 1981; Miller and Guengerich, 1982; Wilson and Wilson, 1985; Nelson *et al.*, 1986; Bouwer and Wright, 1988; Lee, 1988; Little *et al.*, 1988; Mayer *et al.*, 1988; Arciero *et al.*, 1989; Cline and Delfino, 1989; Freedman and Gossett, 1989; Folsom *et al.*, 1990; Harker and Kim, 1990; Alvarez-Cohen and McCarty, 1991a, 1991b; DeStefano *et al.*, 1991; Henry, 1991; McCarty *et al.*, 1992; Hartmans and de Bont, 1992; McCarty and Semprini, 1994; Vogel, 1994). Whereas fuel hydrocarbons are biodegraded through use as a primary substrate (electron donor), chlorinated aliphatic hydrocarbons may undergo biodegradation under three different circumstances: intentional use as an electron acceptor; intentional use as an electron donor; or, through cometabolism where degradation of the chlorinated organic is fortuitous and there is no benefit to the microorganism. At a given site, one or all of these circumstances may pertain, although at many sites the use of chlorinated aliphatic hydrocarbons as electron acceptors appears to be most important under natural conditions. In this case, biodegradation of chlorinated aliphatic hydrocarbons will be an electron-donor-limited process. Conversely, biodegradation of fuel hydrocarbons is an electron-acceptor-limited process.

In an uncontaminated aquifer, native organic carbon is used as an electron donor, and dissolved oxygen (DO) is used first as the prime electron acceptor. Where anthropogenic carbon (e.g., as fuel hydrocarbons) is present, it also will be used as an electron donor. After the DO is consumed, anaerobic microorganisms typically use additional electron acceptors (as available) in the following order of preference: nitrate, ferric iron oxyhydroxide, sulfate, and finally carbon dioxide. Evaluation of the distribution of these electron acceptors can provide evidence of where and how chlorinated aliphatic hydrocarbon biodegradation is occurring. In addition, because chlorinated aliphatic hydrocarbons may be used as electron acceptors or electron donors (in competition with other acceptors or donors), isopleth maps showing the distribution of these compounds and their daughter products can provide evidence of the mechanisms of biodegradation working at a site. As with BTEX, the driving force behind oxidation-reduction reactions resulting in chlorinated aliphatic hydrocarbon degradation is electron transfer. Although thermodynamically favorable, most of the reactions involved in chlorinated aliphatic hydrocarbon reduction and oxidation do not proceed abiotically. Microorganisms are capable of carrying out the reactions, but they will facilitate only those oxidation-reduction reactions that have a net yield of energy.

2.2.1.1 Mechanisms of Chlorinated Aliphatic Hydrocarbon Biodegradation

The following sections describe the biodegradation of those compounds that are most prevalent and whose behavior is best understood.

2.2.1.1.1 Electron Acceptor Reactions (*Reductive Dehalogenation*)

The most important process for the natural biodegradation of the more highly chlorinated solvents is reductive dechlorination. During this process, the chlorinated hydrocarbon is used as an electron acceptor, not as a source of carbon, and a chlorine atom is removed and replaced with a hydrogen atom. Figure 2.2 illustrates the transformation of chlorinated ethenes via reductive dechlorination. In general, reductive dechlorination occurs by sequential dechlorination from PCE to TCE to DCE to VC to ethene. Depending upon environmental conditions, this sequence may be interrupted, with other processes then acting upon the products. During reductive dechlorination, all three isomers of DCE can theoretically be produced. However, Bouwer (1994) reports that under the influence of biodegradation, *cis*-1,2-DCE is a more common intermediate than *trans*-1,2-DCE, and that 1,1-DCE is the least prevalent of the three DCE isomers when they are present as daughter products. Reductive dechlorination of chlorinated solvent compounds is associated with

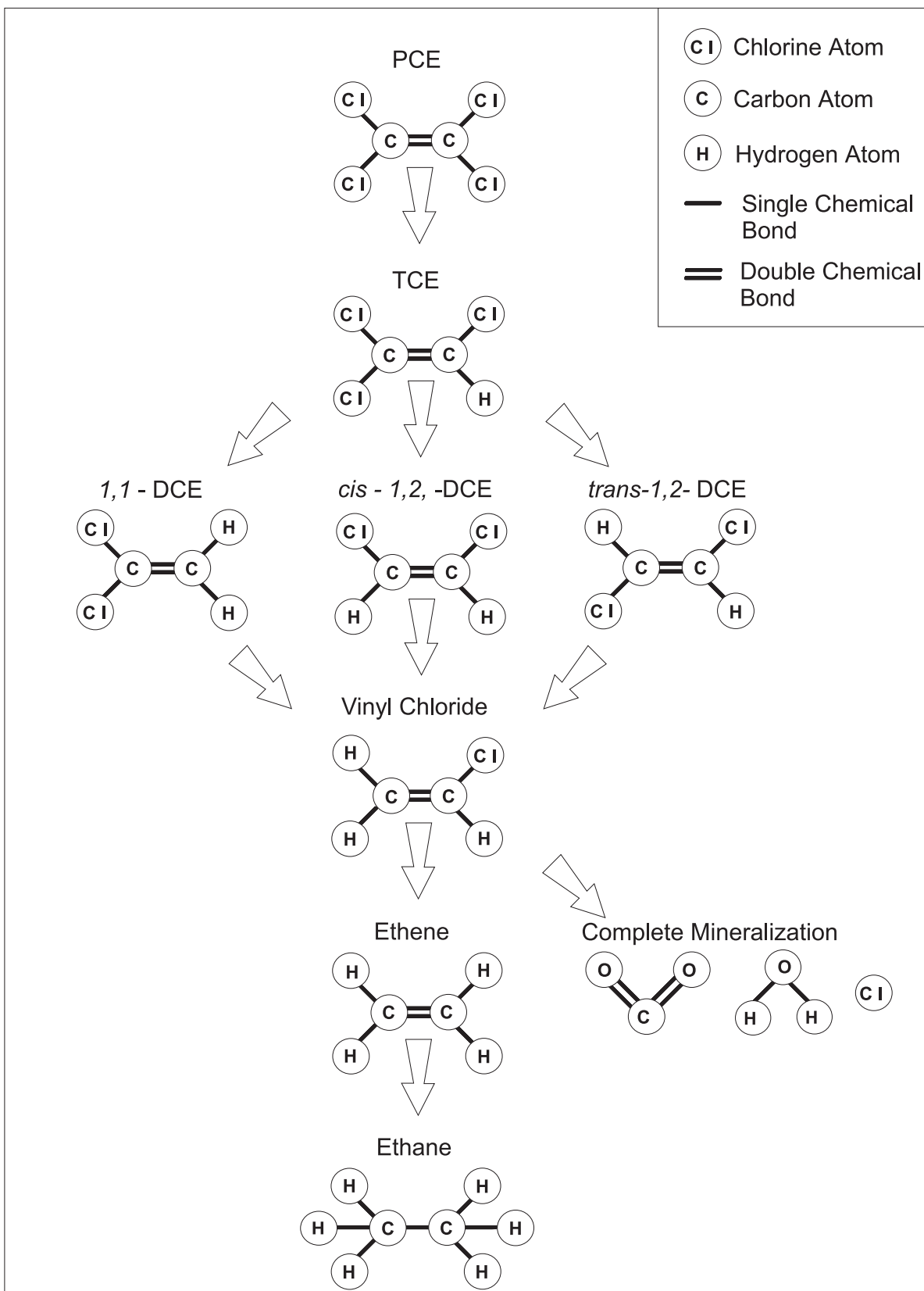

Figure 2.2 Reductive dehalogenation of chlorinated ethenes.

the accumulation of daughter products and an increase in the concentration of chloride ions. Reductive dechlorination affects each of the chlorinated ethenes differently. Of these compounds, PCE is the most susceptible to reductive dechlorination because it is the most oxidized. Conversely, VC is the least susceptible to reductive dechlorination because it is the least oxidized of these compounds. As a result, the rate of reductive dechlorination decreases as the degree of chlorination decreases (Vogel and McCarty, 1985; Bouwer, 1994). Murray and Richardson (1993) have postulated that this rate decrease may explain the accumulation of VC in PCE and TCE plumes that are undergoing reductive dechlorination. Reductive dechlorination has been demonstrated under nitrate- and iron-reducing conditions, but the most rapid biodegradation rates, affecting the widest range of chlorinated aliphatic hydrocarbons, occur under sulfate-reducing and methanogenic conditions (Bouwer, 1994). Because chlorinated aliphatic hydrocarbon compounds are used as electron acceptors during reductive dechlorination, there must be an appropriate source of carbon for microbial growth in order for this process to occur (Bouwer, 1994). Potential carbon sources include natural organic matter, fuel hydrocarbons, or other anthropogenic organic compounds such as those found in landfill leachate.

2.2.1.1.2 *Electron Donor Reactions*

Murray and Richardson (1993) write that microorganisms are generally believed to be incapable of growth using PCE and TCE as a primary substrate (i.e., electron donor). However, under aerobic and some anaerobic conditions, the less oxidized chlorinated aliphatic hydrocarbons (e.g., VC) can be used as the primary substrate in biologically mediated oxidation-reduction reactions (McCarty and Semprini, 1994). In this type of reaction, the facilitating microorganism obtains energy and organic carbon from the degraded chlorinated aliphatic hydrocarbon. In contrast to reactions in which the chlorinated aliphatic hydrocarbon is used as an electron acceptor, only the least oxidized chlorinated aliphatic hydrocarbons can be used as electron donors in biologically mediated oxidation-reduction reactions. McCarty and Semprini (1994) describe investigations in which VC and 1,2-dichloroethane (DCA) were shown to serve as primary substrates under aerobic conditions. These authors also document that dichloromethane has the potential to function as a primary substrate under either aerobic or anaerobic environments. In addition, Bradley and Chapelle (1996) show evidence of mineralization of VC under iron-reducing conditions so long as there is sufficient bioavailable iron (III). Aerobic metabolism of VC may be characterized by a loss of VC mass and a decreasing molar ratio of VC to other chlorinated aliphatic hydrocarbon compounds. In addition, Klier *et al.* (1998) and Bradley and Chapelle (1997) show mineralization of DCE to carbon dioxide under aerobic, Fe(III) reducing, and methanogenic conditions, respectively.

2.2.1.1.3 *Cometabolism*

When a chlorinated aliphatic hydrocarbon is biodegraded via cometabolism, the degradation is catalyzed by an enzyme or cofactor that is fortuitously produced by the organisms for other purposes. The organism receives no known benefit from the degradation of the chlorinated aliphatic hydrocarbon. Rather, the cometabolic degradation of the chlorinated aliphatic hydrocarbon may in fact be harmful to the microorganism responsible for the production of the enzyme or cofactor (McCarty and Semprini, 1994). Cometabolism is best documented in aerobic environments, although it potentially could occur under anaerobic conditions. It has been reported that under aerobic conditions chlorinated ethenes, with the exception of PCE, are susceptible to cometabolic degradation (Murray and Richardson, 1993; Vogel, 1994; McCarty and Semprini, 1994). Vogel (1994) further elaborates that the rate of cometabolism increases as the degree of dechlorination decreases. During cometabolism, the chlorinated alkene is indirectly transformed by bacteria as they use BTEX or

another substrate to meet their energy requirements. Therefore, the chlorinated alkene does not enhance the degradation of BTEX or other carbon sources, nor will its cometabolism interfere with the use of electron acceptors involved in the oxidation of those carbon sources.

2.2.1.2 Behavior of Chlorinated Solvent Plumes

Chlorinated solvent plumes can exhibit three types of behavior depending on the amount of solvent, the amount of biologically available organic carbon in the aquifer, the distribution and concentration of natural electron acceptors, and the types of electron acceptors being used. Individual plumes may exhibit all three types of behavior in different portions of the plume. The different types of plume behavior are summarized below.

2.2.1.2.1 Type 1 Behavior

Type 1 behavior occurs where the primary substrate is anthropogenic carbon (e.g., BTEX or landfill leachate), and microbial degradation of this anthropogenic carbon drives reductive dechlorination. When evaluating natural attenuation of a plume exhibiting Type 1 behavior, the following questions must be answered:

- 1) Is the electron donor supply adequate to allow microbial reduction of the chlorinated organic compounds? In other words, will the microorganisms “strangle” before they “starve” (i.e., will they run out of chlorinated aliphatic hydrocarbons used as electron acceptors before they run out of anthropogenic carbon used as the primary substrate)?
- 2) What is the role of competing electron acceptors (e.g., dissolved oxygen, nitrate, iron (III) and sulfate)?
- 3) Is VC oxidized, or is it reduced?

Appendices B and C discuss what these questions mean and how they are answered. Type 1 behavior results in the rapid and extensive degradation of the more highly-chlorinated solvents such as PCE, TCE, and DCE.

2.2.1.2.2 Type 2 Behavior

Type 2 behavior dominates in areas that are characterized by relatively high concentrations of biologically available native organic carbon. Microbial utilization of this natural carbon source drives reductive dechlorination (i.e., it is the primary substrate for microorganism growth). When evaluating natural attenuation of a Type 2 chlorinated solvent plume, the same questions as those posed in the description of Type 1 behavior must be answered. Type 2 behavior generally results in slower biodegradation of the highly chlorinated solvents than Type 1 behavior, but under the right conditions (e.g., areas with high natural organic carbon contents), this type of behavior also can result in rapid degradation of these compounds.

2.2.1.2.3 Type 3 Behavior

Type 3 behavior dominates in areas that are characterized by inadequate concentrations of native and/or anthropogenic carbon, and concentrations of dissolved oxygen that are greater than 1.0 mg/L. Under these aerobic conditions, reductive dechlorination will not occur. The most significant natural attenuation mechanisms for PCE, TCE, and DCE will be advection, dispersion, and sorption. However, VC can be rapidly oxidized under these conditions. Type 3 behavior also occurs in ground water that does not contain microbes capable of biodegradation of chlorinated solvents.

2.2.1.2.4 Mixed Behavior

As mentioned above, a single chlorinated solvent plume can exhibit all three types of behavior in different portions of the plume. This can be beneficial for natural biodegradation of chlorinated aliphatic hydrocarbon plumes. For example, Wiedemeier *et al.* (1996a) describe a plume at Plattsburgh AFB, New York, that exhibits Type 1 behavior in the source area and Type 3 behavior downgradient from the source. The most fortuitous scenario involves a plume in which PCE, TCE, and DCE are reductively dechlorinated with accumulation of VC near the source area (Type 1 or Type 2 behavior), then VC is oxidized (Type 3 behavior), either aerobically or via iron reduction further downgradient. Vinyl chloride is oxidized to carbon dioxide in this type of plume and does not accumulate. The following sequence of reactions occurs in a plume that exhibits this type of mixed behavior.



In general, TCE, DCE, and VC may attenuate at approximately the same rate, and thus these reactions may be confused with simple dilution. Note that no ethene is produced during this reaction. Vinyl chloride is removed from the system much faster under these conditions than it is under VC-reducing conditions.

A less desirable scenario, but one in which all contaminants may be entirely biodegraded, involves a plume in which all chlorinated aliphatic hydrocarbons are reductively dechlorinated via Type 1 or Type 2 behavior. Vinyl chloride is reduced to ethene, which may be further reduced to ethane or methane. The following sequence of reactions occurs in this type of plume.



This sequence has been investigated by Freedman and Gossett (1989). In this type of plume, VC degrades more slowly than TCE, and thus tends to accumulate.

2.2.2 Bioattenuation Screening Process

An accurate assessment of the potential for natural biodegradation of chlorinated compounds should be made before investing in a detailed study of natural attenuation. The screening process presented in this section is outlined in Figure 2.3. This approach should allow the investigator to determine if natural bioattenuation of PCE, TCE, DCE, TCA, and chlorobenzenes is likely to be a viable remedial alternative before additional time and money are expended. If the site is regulated under CERCLA, much of the data required to make the preliminary assessment of natural attenuation will be used to evaluate alternative engineered remedial solutions as required by the NCP. Table 2.3 presents the analytical screening criteria.

For most of the chlorinated solvents, the initial biotransformation in the environment is a reductive dechlorination. The initial screening process is designed to recognize geochemical environments where reductive dechlorination is plausible. It is recognized, however, that biodegradation of certain halogenated compounds can also proceed via oxidative pathways. Examples include DCE, VC, the dichloroethanes, chloroethane, dichlorobenzenes, monochlorobenzene, methylene chloride, and ethylene dibromide.

The following information is required for the screening process:

- The chemical and geochemical data presented in Table 2.3 for background and target areas of the plume as depicted in Figure 2.4. Figure 2.4 shows the schematic locations of these data collection points. Note: If other contaminants are suspected, then data on the concentrations and distribution of these compounds also should be obtained.
- Locations of source(s) and potential points of exposure. If subsurface NAPLs are sources, estimate extent of residual and free-phase NAPL.
- An estimate of the transport velocity and direction of ground-water flow.

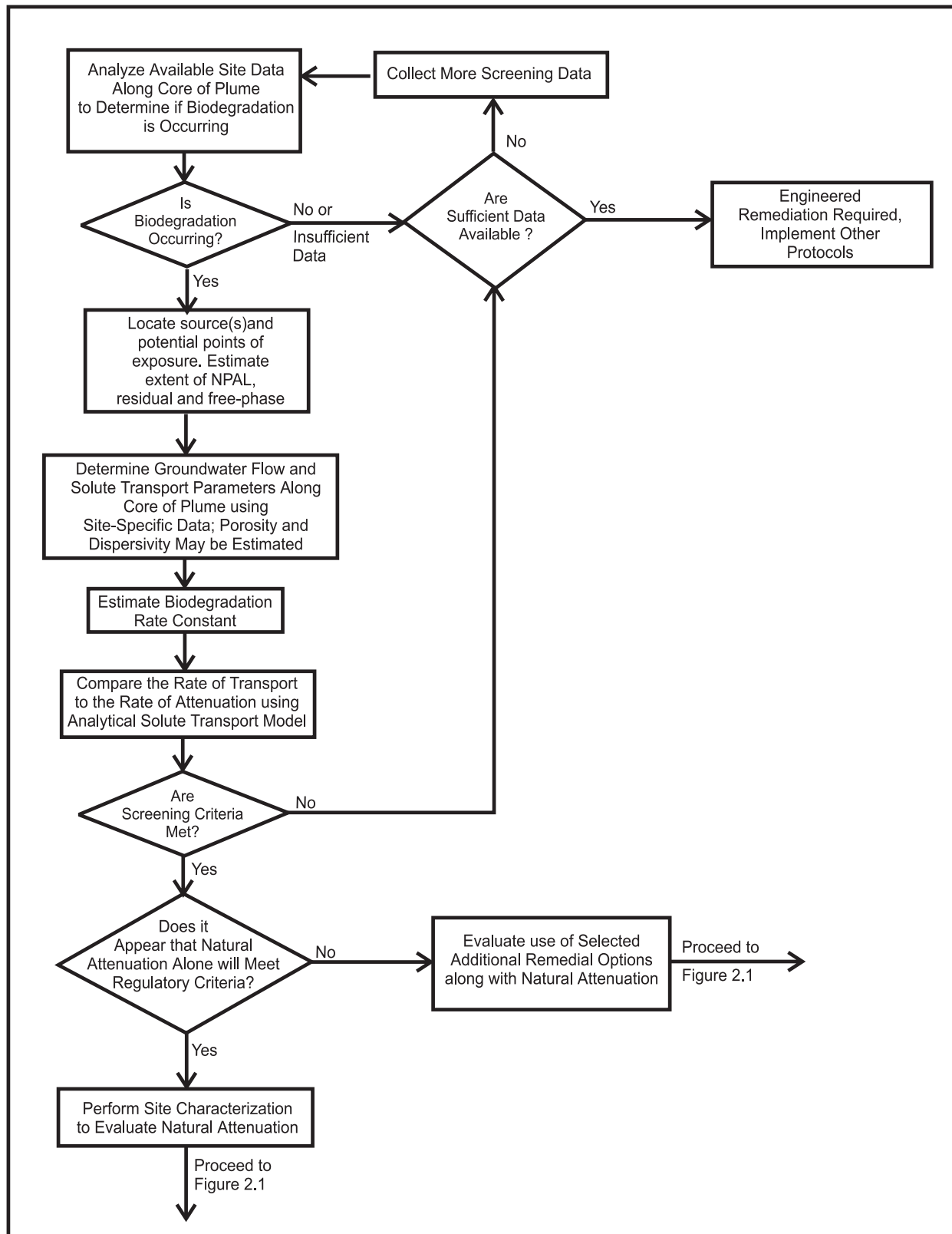

Figure 2.3 Initial screening process flow chart.

Table 2.3 Analytical Parameters and Weighting for Preliminary Screening for Anaerobic Biodegradation Processes^{a/}

Analysis	Concentration in Most Contaminated Zone	Interpretation	Value
Oxygen*	<0.5 mg/L	Tolerated, suppresses the reductive pathway at higher concentrations	3
Oxygen*	>5 mg/L	Not tolerated; however, VC may be oxidized aerobically	-3
Nitrate*	<1 mg/L	At higher concentrations may compete with reductive pathway	2
Iron II*	>1 mg/L	Reductive pathway possible; VC may be oxidized under Fe(III)-reducing conditions	3
Sulfate*	<20 mg/L	At higher concentrations may compete with reductive pathway	2
Sulfide*	>1 mg/L	Reductive pathway possible	3
Methane*	<0.5 mg/L	VC oxidizes	0
	>0.5 mg/L	Ultimate reductive daughter product, VC Accumulates	3
Oxidation Reduction Potential* (ORP) against Ag/AgCl electrode	<50 millivolts (mV)	Reductive pathway possible	1
	<-100mV	Reductive pathway likely	2
pH*	5 < pH < 9	Optimal range for reductive pathway	0
	5 > pH >9	Outside optimal range for reductive pathway	-2
TOC	> 20 mg/L	Carbon and energy source; drives dechlorination; can be natural or anthropogenic	2
Temperature*	> 20°C	At T >20°C biochemical process is accelerated	1
Carbon Dioxide	>2x background	Ultimate oxidative daughter product	1
Alkalinity	>2x background	Results from interaction between CO ₂ and aquifer minerals	1
Chloride*	>2x background	Daughter product of organic chlorine	2
Hydrogen	>1 nM	Reductive pathway possible, VC may accumulate	3
Hydrogen	<1 nM	VC oxidized	0
Volatile Fatty Acids	> 0.1 mg/L	Intermediates resulting from biodegradation of more complex compounds; carbon and energy source	2
BTEX*	> 0.1 mg/L	Carbon and energy source; drives dechlorination	2
Tetrachloroethene		Material released	0
Trichloroethene*		Material released	0
		Daughter product of PCE	2 ^{a/}
DCE*		Material released	0
		Daughter product of TCE	2 ^{a/}
		If cis is > 80% of total DCE it is likely a daughter product 1,1-DCE can be chemical reaction product of TCA	
VC*		Material released	0
		Daughter product of DCE	2 ^{a/}
1,1,1-Trichloroethane*		Material released	0
DCA		Daughter product of TCA under reducing conditions	2
Carbon Tetrachloride		Material released	0
Chloroethane*		Daughter product of DCA or VC under reducing conditions	2
Ethene/Ethane	>0.01mg/L	Daughter product of VC/ethene	2
	>0.1 mg/L		3
Chloroform		Material released	0
		Daughter product of Carbon Tetrachloride	2
Dichloromethane		Material released	0
		Daughter product of Chloroform	2

* Required analysis. a/ Points awarded only if it can be shown that the compound is a daughter product (i.e., not a constituent of the source NAPL).

Once these data have been collected, the screening process can be undertaken. The following steps summarize the screening processes:

- 1) Determine if biodegradation is occurring using geochemical data. If biodegradation is occurring, proceed to step 2. If it is not, assess the amount and types of data available. If data are insufficient to determine if biodegradation is occurring, collect supplemental data. If all the recommended screening parameters listed in section 2.2 have been collected and the screening processes suggest that natural attenuation is not appropriate, the screening processes are finished. Perform site characterization to evaluate other remediation alternatives.
- 2) Determine ground-water flow and solute transport parameters from representative field data. Dispersivity and porosity may be estimated from literature but the hydraulic conductivity and the ground-water gradient and flow direction must be determined from field data. The investigator should use the highest valid hydraulic conductivity measured at the site during the preliminary screening because solute plumes tend to follow the path of least resistance (i.e., highest hydraulic conductivity). This will give the “worst-case” estimate of the solute migration distance over a given period of time. Compare this “worst-case” estimate with the rate of plume migration determined from site characterization data. Determine what degree of plume migration is acceptable or unacceptable with respect to site-specific remediation objectives.
- 3) Locate source(s) and potential points of exposure. If subsurface NAPLs are sources, estimate extent of residual and free-phase NAPL.
- 4) Estimate the biodegradation rate constant. Biodegradation rate constants can be estimated using a conservative tracer found commingled with the contaminant plume, as described in Appendix C and by Wiedemeier *et al.* (1996b). When dealing with a plume that contains chlorinated solvents, this procedure can be modified to use chloride as a tracer. Rate constants derived from microcosm studies can also be used when site specific field data are inadequate or inconclusive. If it is not possible to estimate the biodegradation rate using these procedures, then use a range of accepted literature values for biodegradation of the contaminants of concern. Appendix C presents a range of biodegradation rate constants for various compounds. Although literature values may be used to estimate biodegradation rates in the bioattenuation screening process described in Section 2.2, literature values should not be used in the later more detailed analysis of natural attenuation, described in Section 2.3.
- 5) Compare the rate of transport to the rate of attenuation.
Use analytical solutions or a screening model such as BIOSCREEN.
- 6) Determine if screening criteria are met.

Step 1: Determine if Biodegradation is Occurring

The first step in the screening process is to sample or use existing data for the areas represented in Figure 2.4 and analyze them for the parameters listed in Table 2.3 (see also Section 2.3.2). These areas should include (1) the most contaminated portion of the aquifer (generally in the “source” area with NAPL or high concentrations of contaminants in ground water); (2) downgradient from the source area but still in the dissolved contaminant plume; (3) downgradient from the dissolved contaminant plume; and (4) upgradient and lateral locations that are not impacted by the plume. Although this figure is a simplified two-dimensional representation of the features of a contaminant plume, real plumes are three-dimensional objects. The sampling should be conducted in accordance with Appendix A.

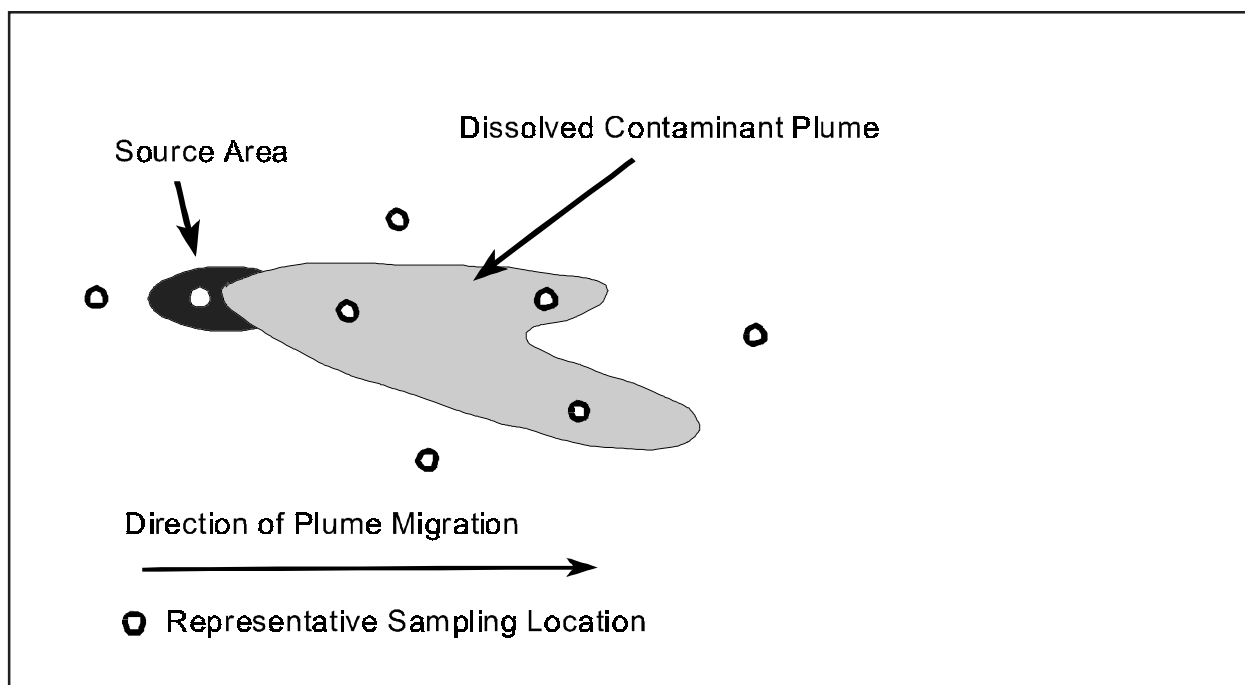

Figure 2.4 Target areas for collecting screening data. Note that the number and location of monitoring wells will vary with the three dimensional complexity of the plume(s).

The sample collected in the NAPL source area provides information as to the predominant terminal electron-accepting process at the source area. In conjunction with the sample collected in the NAPL source zone, samples collected in the dissolved plume downgradient from the NAPL source zone allow the investigator (1) to determine if the plume is degrading with distance along the flow path and (2) to determine the distribution of electron acceptors and donors and metabolic by-products along the flow path. The sample collected downgradient from the dissolved plume aids in plume delineation and allows the investigator to determine if metabolic byproducts are present in an area of ground water that has been remediated. The upgradient and lateral samples allow delineation of the plume and determination of background concentrations of the electron acceptors and donors.

After these samples have been analyzed for the parameters listed in Table 2.3, the investigator should analyze the data to determine if biodegradation is occurring. The right-hand column of Table 2.3 contains scoring values that can be used as a test to assess the likelihood that biodegradation is occurring. This method relies on the fact that biodegradation will cause predictable changes in ground water chemistry. For example, if the dissolved oxygen concentration in the area of the plume with the highest contaminant concentration is less than 0.5 milligrams per liter (mg/L), 3 points are awarded. Table 2.4 summarizes the range of possible scores and gives an interpretation for each score. If the score totals 15 or more points, it is likely that biodegradation is occurring, and the investigator should proceed to Step 2.

Table 2.4 Interpretation of Points Awarded During Screening Step 1

Score	Interpretation
0 to 5	Inadequate evidence for anaerobic biodegradation* of chlorinated organics
6 to 14	Limited evidence for anaerobic biodegradation* of chlorinated organics
15 to 20	Adequate evidence for anaerobic biodegradation* of chlorinated organics
> 20	Strong evidence for anaerobic biodegradation* of chlorinated organics

*reductive dechlorination

The following two examples illustrate how Step 1 of the screening process is implemented. The site used in the first example is a former fire training area contaminated with chlorinated solvents mixed with fuel hydrocarbons. The presence of the fuel hydrocarbons appears to reduce the ORP of the ground water to the extent that reductive dechlorination is favorable. The second example contains data from a dry cleaning site contaminated only with chlorinated solvents. This site was contaminated with spent cleaning solvents that were dumped into a shallow dry well situated just above a well-oxygenated, unconfined aquifer with low organic carbon concentrations of dissolved organic carbon.

Example 1: Strong Evidence for Anaerobic Biodegradation (Reductive Dechlorination) of Chlorinated Organics

Analyte	Concentration in Most Contaminated Zone	Points Awarded
Dissolved Oxygen	0.1 mg/L	3
Nitrate	0.3 mg/L	2
Iron (II)	10 mg/L	3
Sulfate	2 mg/L	2
Methane	5 mg/L	3
ORP	-190 mV	2
Chloride	3 times background	2
PCE (released)	1,000 µg/L	0
TCE (none released)	1,200 µg/L	2
cis-DCE (none released)	500 µg/L	2
VC (none released)	50 µg/L	2
Total Points Awarded		23 Points

In this example, the investigator can infer that biodegradation is likely occurring at the time of sampling and may proceed to Step 2.

Example 2: Anaerobic Biodegradation (Reductive Dechlorination) Unlikely

Analyte	Concentration in Most Contaminated Zone	Points Awarded
Dissolved Oxygen	3 mg/L	-3
Nitrate	0.3 mg/L	2
Iron (II)	Not Detected (ND)	0
Sulfate	10 mg/L	2
Methane	ND	0
ORP	+ 100 mV	0
Chloride	background	0
TCE (released)	1,200 µg/L	0
cis-DCE (none released)	ND	0
VC (none released)	ND	0
Total Points Awarded		1 Point

In this example, the investigator can infer that biodegradation is probably not occurring or is occurring too slowly to contribute to natural attenuation at the time of the sampling. In this case, the investigator should evaluate whether other natural attenuation processes can meet the cleanup objectives for the site (e.g., abiotic degradation or transformation, volatilization or sorption) or select a remedial option other than MNA.

Step 2: Determine Ground-water Flow and Solute Transport Parameters

After it has been shown that biodegradation is occurring, it is important to quantify ground-water flow and solute transport parameters. This will make it possible to use a solute transport model to quantitatively estimate the concentration of the plume and its direction and rate of travel. To use an analytical model, it is necessary to know the hydraulic gradient and hydraulic conductivity for the site and to have estimates of porosity and dispersivity. It also is helpful to know the coefficient of retardation. Quantification of these parameters is discussed in detail in Appendix B.

In order to make the modeling as accurate as possible, the investigator must have site-specific hydraulic gradient and hydraulic conductivity data. To determine the ground-water flow and solute transport direction, it is necessary to have at least three accurately surveyed wells in each hydrogeologic unit of interest at the site. The porosity and dispersivity are generally estimated using accepted literature values for the aquifer matrix materials containing the plume at the site. If the investigator has total organic carbon data for soil, it is possible to estimate the coefficient of retardation; otherwise, it is conservative to assume that the solute transport and ground-water velocities are the same. Techniques to collect these data are discussed in the appendices.

Step 3: Locate Sources and Receptor Exposure Points

To determine the length of flow for the predictive modeling to be conducted in Step 5, it is important to know the distance between the source of contamination, the leading edge along the core of the dissolved plume, and any potential downgradient or cross-gradient receptor exposure points.

Step 4: Estimate the Biodegradation Rate

Biodegradation is the most important process that degrades contaminants in the subsurface; therefore, the biodegradation rate is one of the most important model input parameters. Biodegradation of chlorinated aliphatic hydrocarbons can be represented as a first-order rate constant. Whenever possible, use site-specific biodegradation rates estimated from field data collected along the core of the plume. Calculation of site-specific biodegradation rates is discussed in Appendix C. If it is not possible to determine site-specific biodegradation rates, then literature values may be used in a sensitivity analysis (Table C.3.5). A useful approach is to start with average values, and then to vary the model input to predict “best-case” and “worst-case” scenarios. Estimated biodegradation rates can be used only after it has been shown that biodegradation is occurring (see Step 1). Although literature values may be used to estimate biodegradation rates in the bioattenuation screening process described in Section 2.2, additional site information should be collected to determine biodegradation rates for the site when refining the site conceptual model, as described in Section 2.3. Literature values should not be used during the more detailed analysis.

Step 5: Compare the Rate of Transport to the Rate of Attenuation

At this early stage in the natural attenuation demonstration, comparison of the rate of solute transport to the rate of attenuation is best accomplished using an analytical model. Several models are available. It is suggested that the decay option be first order for use in any of the models.

The primary purpose of comparing the rate of transport to the rate of natural attenuation is to determine if natural attenuation processes will be capable of attaining site-specific remediation objectives in a time period that is reasonable compared to other alternatives (i.e., to quantitatively

estimate if site contaminants are attenuating at a rate fast enough to prevent further plume migration and restore the plume to appropriate cleanup levels). The analytical model BIOSCREEN can be used to determine whether natural attenuation processes will be capable of meeting site-specific remediation objectives at some distance downgradient of a source. The numerical model BIOPLUME III can be used to estimate whether site contaminants are attenuating at a rate fast enough to restore the plume to appropriate cleanup levels. It is important to perform a sensitivity analysis to help evaluate the confidence in the preliminary screening modeling effort. For the purposes of the screening effort, if modeling shows that the screening criteria are met, the investigator can proceed with the natural attenuation evaluation.

Step 6: Determine if Screening Criteria are Met

Before proceeding with the full-scale natural attenuation evaluation, the investigator should ensure that the answers to both of the following questions are “yes”:

- Has the plume moved a shorter distance than would be expected based on the known (or estimated) time since the contaminant release and the contaminant velocity in ground water, as calculated from site-specific measurements of hydraulic conductivity and hydraulic gradient, and estimates of effective porosity and contaminant retardation?
- Is it likely that site contaminants are attenuating at rates sufficient to meet remediation objectives for the site in a time period that is reasonable compared to other alternatives?

If the answers to these questions are “yes,” then the investigator is encouraged to proceed with the full-scale natural attenuation demonstration.

2.3 COLLECT ADDITIONAL SITE CHARACTERIZATION DATA TO EVALUATE NATURAL ATTENUATION AS REQUIRED

It is the responsibility of the proponent to “make the case” for natural attenuation. Thus, a credible and thorough site assessment is necessary to document the potential for natural attenuation to meet cleanup objectives. As discussed in Section 2.1, review of existing site characterization data is particularly useful before initiating site characterization activities. Such review should allow identification of data gaps and guide the most effective placement of additional data collection points.

There are two goals during the site characterization phase of a natural attenuation investigation. The first is to collect the data needed to determine if natural mechanisms of contaminant attenuation are occurring at rates sufficient to attain site-specific remediation objectives in a time period that is reasonable compared to other alternatives. The second is to provide sufficient site-specific data to allow prediction of the future extent and concentrations of a contaminant plume through solute fate and transport modeling. Thus, detailed site characterization is required to achieve these goals and to support this remedial option. Adequate site characterization in support of natural attenuation requires that the following site-specific parameters be determined:

- Location, nature, and extent of contaminant source area(s) (i.e., areas containing mobile or residual NAPL or highly contaminated ground water).
- Chemical properties (e.g., composition, solubility, volatility, etc.) of contaminant source materials.
- The potential for a continuing source due to sewers, leaking tanks, or pipelines, or other site activity.
- Extent and types of soil and ground-water contamination.
- Aquifer geochemical parameters (Table 2.1).

- Regional hydrogeology, including:
 - Drinking water aquifers, and
 - Regional confining units.
- Local and site-specific hydrogeology, including:
 - Local drinking water aquifers;
 - Location of industrial, agricultural, and domestic water wells;
 - Patterns of aquifer use (current and future);
 - Lithology;
 - Site stratigraphy, including identification of transmissive and nontransmissive units;
 - Potential pathways for NAPL migration (e.g., surface topography and dip of confining layers);
 - Grain-size distribution (sand vs. silt vs. clay);
 - Aquifer hydraulic conductivity;
 - Ground water hydraulic information;
 - Preferential flow paths;
 - Locations and types of surface water bodies; and
 - Areas of local ground water recharge and discharge.
- Identification of current and future potential exposure pathways, receptors, and exposure points.

Many chlorinated solvent plumes have enough three-dimensional expression to make it impossible for a single well to adequately describe the plume at a particular location on a map of the site.

Figure 2.5 depicts a cross section of a hypothetical site with three-dimensional expression of the plume. A documented source exists in the capillary fringe just above the water table. Such sources are usually found by recovering, extracting, and analyzing core material. This material can be (1) a release of LNAPL containing chlorinated solvents; (2) a release of pure chlorinated solvents that has been entrapped by capillary interactions in the capillary fringe; or (3) material that has experienced high concentrations of solvents in solution in ground water, has sorbed the solvents, and now is slowly desorbing the chlorinated solvents. Recharge of precipitation through this source produces a plume that appears to dive into the aquifer as it moves away from the source. This effect can be caused by recharge of clean ground water above the plume as it moves downgradient of the source, by collection of the plume into more hydraulically conductive material at the bottom of the aquifer, or by density differences between the plume and the unimpacted ground water.

Below the first hydrologic unit there is a second unit that has fine-textured material at the top and coarse-textured material at the bottom of the unit. In the hypothetical site, the fine-textured material at the top of the second unit has inhibited downward migration of a DNAPL, causing it to spread laterally at the bottom of the first unit and form a second source of ground-water contamination in the first unit. Because DNAPL below the water table tends to exist as diffuse and widely extended ganglia rather than of pools filling all the pore space, it is statistically improbable that the material sampled by conventional core sampling will contain DNAPL. Because these sources are so difficult to sample, these sources are cryptic to conventional sampling techniques.

At the hypothetical site, DNAPL has found a pathway past the fine-textured material and has formed a second cryptic source area at the bottom of the second hydrologic unit. Compare Figure 2.6. The second hydrologic unit at the hypothetical site has a different hydraulic gradient than the first unit. As a result, the plume in the second unit is moving in a different direction than the plume in the first unit. Biological processes occurring in one hydrologic unit may not occur in another; a plume may show Type 2 behavior in one unit and Type 3 behavior in another.

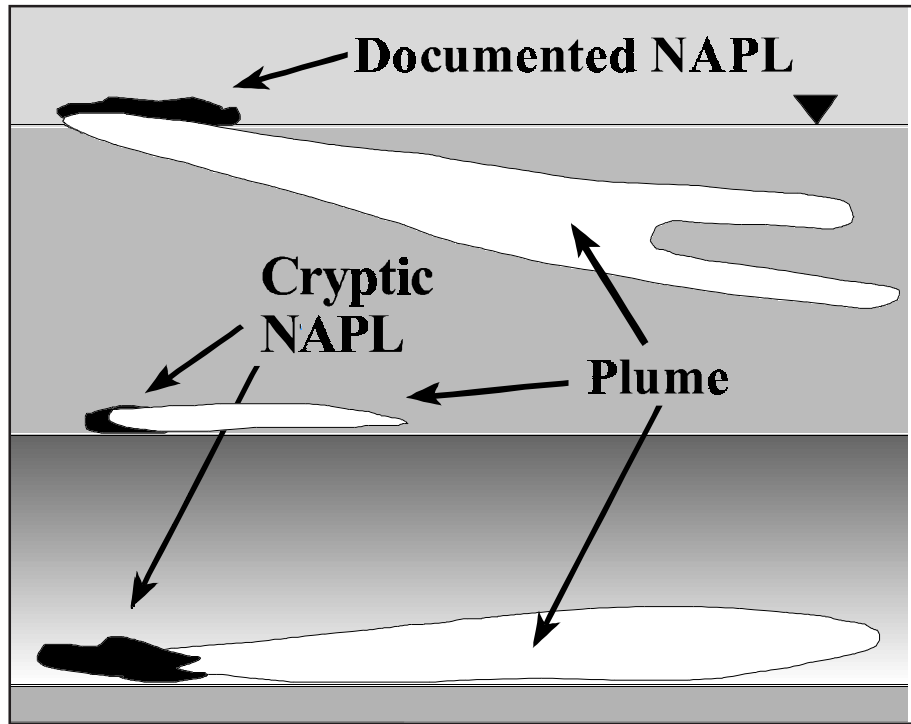

Figure 2.5 A cross section through a hypothetical release, illustrating the three-dimensional character of the plumes that may develop from a release of chlorinated solvents.

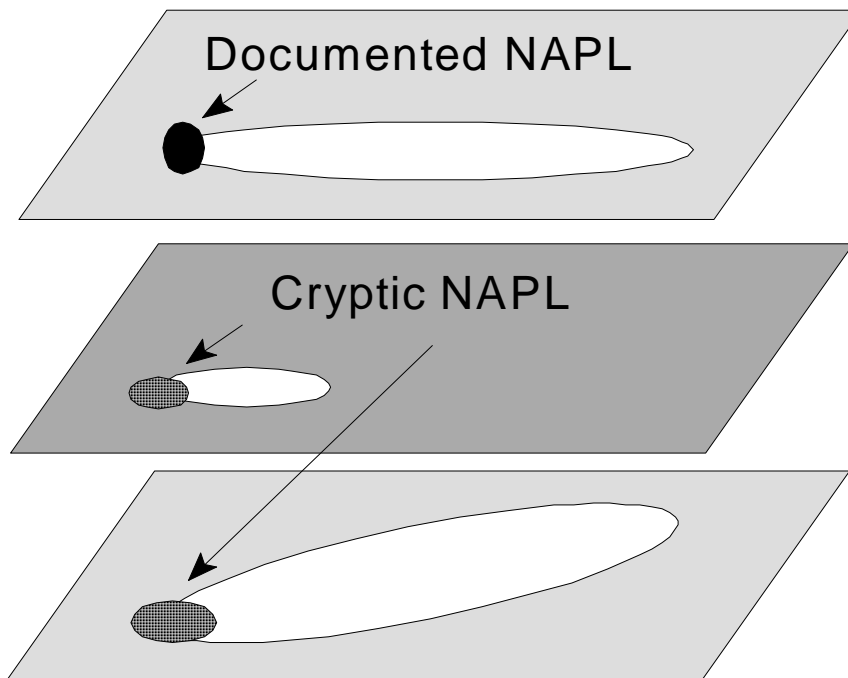

Figure 2.6 A stacked plan representation of the plumes that may develop from the hypothetical release depicted in Figure 2.5. Each plan representation depicts a separate plume that can originate from discrete source areas produced from the same release of chlorinated solvents.

As a consequence, it is critical to sample and evaluate the three-dimensional character of the site with respect to (1) interaction of contaminant releases with the aquifer matrix material, (2) local hydrological features that control development and migration of plumes, and (3) the geochemical interactions that favor bioattenuation of chlorinated solvents.

The following sections describe the methodologies that should be implemented to allow successful site characterization in support of natural attenuation.

2.3.1 Characterization of Soils and Aquifer Matrix Materials

In order to adequately define the subsurface hydrogeologic system and to determine the three-dimensional distribution of mobile and residual NAPL that can act as a continuing source of ground-water contamination, credible and thorough soil characterization must be completed. As appropriate, soil gas data may be collected and analyzed to better characterize soil contamination in the vadose zone. Depending on the status of the site, this work may have been completed during previous remedial investigation work. The results of soils characterization will be used as input into a solute fate and transport model to help define a contaminant source term and to support the natural attenuation investigation.

The purpose of sampling soil and aquifer matrix material is to determine the subsurface distribution of hydrostratigraphic units and the distribution of mobile and residual NAPL, as well as pore water that contains high concentrations of the contaminants in the dissolved phase. These objectives can be achieved through the use of conventional soil borings or direct-push methods (e.g., Geoprobe® or cone penetrometer testing), and through collection of soil gas samples. All samples should be collected, described, analyzed, and disposed of in accordance with local, State, and Federal guidance. Appendix A contains suggested procedures for sample collection. These procedures may require modification to comply with local, State, and Federal regulations or to accommodate site-specific conditions.

The analytical methods to be used for soil, aquifer matrix material, and soil gas sample analyses is presented in Table 2.1. This table includes all of the parameters necessary to document natural attenuation, including the effects of sorption, volatilization, and biodegradation. Each analyte is discussed separately below.

- **Volatile Organic Compounds:** Knowledge of the location, distribution, concentration, and total mass of contaminants sorbed to soils or present as mobile or immobile NAPL is required to calculate contaminant partitioning from NAPL into ground water. This information is useful to predict the long-term persistence of source areas. Knowledge of the diffusive flux of volatile organic compounds from NAPLs or ground water to the atmosphere or other identified receptor for vapors is required to estimate exposure of the human population or ecological receptors to contaminant vapors. If the flux of vapors can be compared to the discharge of the contaminants in ground water, the contribution of volatilization to natural attenuation of contamination in ground water can be documented.
- **Total Organic Carbon:** Knowledge of the TOC content of the aquifer matrix is important for sorption and solute-retardation calculations. TOC samples should be collected from a background location in the stratigraphic horizon(s) where most contaminant transport is expected to occur.
- **Oxygen and Carbon Dioxide:** Oxygen and carbon dioxide soil gas measurements can be used to identify areas in the unsaturated zone where biodegradation is occurring. This can be a useful and relatively inexpensive way to identify NAPL source areas, particularly when solvents are codisposed with fuels or greases (AFCEE, 1994).

- **Fuel and Chlorinated Volatile Organic Compounds:** Knowledge of the distribution of contaminants in soil gas can be used as a cost-effective way to estimate the extent of soil contamination.

2.3.2 Ground-water Characterization

To adequately determine the amount and three-dimensional distribution of dissolved contamination and to document the occurrence of natural attenuation, ground-water samples must be collected and analyzed. Biodegradation of organic compounds, whether natural or anthropogenic, brings about measurable changes in the chemistry of ground water in the affected area. By measuring these changes, it is possible to document and quantitatively evaluate the importance of natural attenuation at a site.

Ground-water sampling is conducted to determine the concentrations and distribution of contaminants, daughter products, and ground-water geochemical parameters. Ground-water samples may be obtained from monitoring wells or with point-source sampling devices such as a Geoprobe®, Hydropunch®, or cone penetrometer. All ground-water samples should be collected, handled, and disposed of in accordance with local, State, and Federal guidelines. Appendix A contains suggested procedures for ground-water sample collection. These procedures may need to be modified to comply with local, State, and Federal regulations or to accommodate site-specific conditions.

The analytical protocol for ground-water sample analysis is presented in Table 2.1. This analytical protocol includes all of the parameters necessary to delineate dissolved contamination and to document natural attenuation, including the effects of sorption and biodegradation. Data obtained from the analysis of ground water for these analytes is used to scientifically document natural attenuation and can be used as input into a solute fate and transport model. The following paragraphs describe each ground-water analytical parameter and the use of each analyte in the natural attenuation demonstration.

2.3.2.1 Volatile and Semivolatile Organic Compounds

These analytes are used to determine the type, concentration, and distribution of contaminants and daughter products in the aquifer. In many cases, chlorinated solvents are found commingled with fuels or other hydrocarbons. At a minimum, the volatile organic compound (VOC) analysis (Method SW8260A) should be used, with the addition of the trimethylbenzene isomers if fuel hydrocarbons are present or suspected. The combined dissolved concentrations of BTEX and trimethylbenzenes should not be greater than about 30 mg/L for a JP-4 spill (Smith *et al.*, 1981) or about 135 mg/L for a gasoline spill (Cline *et al.*, 1991; American Petroleum Institute, 1985). If these compounds are found in higher concentrations, sampling errors such as emulsification of LNAPL in the ground-water sample likely have occurred and should be investigated.

Maximum concentrations of chlorinated solvents dissolved in ground water from neat solvents should not exceed their solubilities in water. Appendix B contains solubilities for common contaminants. If contaminants are found in concentrations greater than their solubilities, then sampling errors such as emulsification of NAPL in the ground-water sample have likely occurred and should be investigated.

2.3.2.2 Dissolved Oxygen

Dissolved oxygen is the most thermodynamically favored electron acceptor used by microbes for the biodegradation of organic carbon, whether natural or anthropogenic. Anaerobic bacteria generally cannot function at dissolved oxygen concentrations greater than about 0.5 mg/L and, hence, reductive dechlorination will not occur. This is why it is important to have a source of carbon in the aquifer that can be used by aerobic microorganisms as a primary substrate. During

aerobic respiration, dissolved oxygen concentrations decrease. After depletion of dissolved oxygen, anaerobic microbes will use nitrate as an electron acceptor, followed by iron (III), then sulfate, and finally carbon dioxide (methanogenesis). Each sequential reaction drives the ORP of the ground water downward into the range within which reductive dechlorination can occur. Reductive dechlorination is most effective in the ORP range corresponding to sulfate reduction and methanogenesis, but dechlorination of PCE and TCE also may occur in the ORP range associated with denitrification or iron (III) reduction. Dehalogenation of DCE and VC generally are restricted to sulfate reducing and methanogenic conditions.

Dissolved oxygen measurements should be taken during well purging and immediately before and after sample acquisition using a direct-reading meter. Because most well purging techniques can allow aeration of collected ground-water samples, it is important to minimize the potential for aeration as described in Appendix A.

2.3.2.3 Nitrate

After dissolved oxygen has been depleted in the microbiological treatment zone, nitrate may be used as an electron acceptor for anaerobic biodegradation of organic carbon via denitrification. In order for reductive dechlorination to occur, nitrate concentrations in the contaminated portion of the aquifer must be less than 1.0 mg/L.

2.3.2.4 Iron (II)

In some cases, iron (III) is used as an electron acceptor during anaerobic biodegradation of organic carbon. During this process, iron (III) is reduced to iron (II), which may be soluble in water. Iron (II) concentrations can thus be used as an indicator of anaerobic degradation of fuel compounds, and vinyl chloride (see Section 2.2.1.1.2). Native organic matter may also support reduction of iron (II). Care must be taken when interpreting iron (II) concentrations because they may be biased low by reprecipitation as sulfides or carbonates.

2.3.2.5 Sulfate

After dissolved oxygen and nitrate have been depleted in the microbiological treatment zone, sulfate may be used as an electron acceptor for anaerobic biodegradation. This process is termed “sulfate reduction” and results in the production of sulfide. Concentrations of sulfate greater than 20 mg/L may cause competitive exclusion of dechlorination. However, in many plumes with high concentrations of sulfate, reductive dechlorination still occurs.

2.3.2.6 Methane

During methanogenesis acetate is split to form carbon dioxide and methane, or carbon dioxide is used as an electron acceptor, and is reduced to methane. Methanogenesis generally occurs after oxygen, nitrate, and sulfate have been depleted in the treatment zone. The presence of methane in ground water is indicative of strongly reducing conditions. Because methane is not present in fuel, the presence of methane above background concentrations in ground water in contact with fuels is indicative of microbial degradation of hydrocarbons. Methane also is associated with spills of pure chlorinated solvents (Weaver *et al.*, 1996). It is not known if the methane comes from chlorinated solvent carbon or from native dissolved organic carbon.

2.3.2.7 Alkalinity

There is a positive correlation between zones of microbial activity and increased alkalinity. Increases in alkalinity result from the dissolution of rock driven by the production of carbon dioxide produced by the metabolism of microorganisms. Alkalinity is important in the maintenance of ground-water pH because it buffers the ground water system against acids generated during both

aerobic and anaerobic biodegradation. In the experience of the authors, biodegradation of organic compounds rarely, if ever, generates enough acid to impact the pH of the ground water.

2.3.2.8 Oxidation-Reduction Potential

The ORP of ground water is a measure of electron activity and is an indicator of the relative tendency of a solution to accept or transfer electrons. Oxidation-reduction reactions in ground water containing organic compounds (natural or anthropogenic) are usually biologically mediated, and, therefore, the ORP of a ground water system depends upon and influences rates of biodegradation. Knowledge of the ORP of ground water also is important because some biological processes operate only within a prescribed range of ORP conditions.

ORP measurements can be used to provide real-time data on the location of the contaminant plume, especially in areas undergoing anaerobic biodegradation. Mapping the ORP of the ground water while in the field helps the field scientist to determine the approximate location of the contaminant plume. To map the ORP of the ground water while in the field, it is important to have at least one ORP measurement (preferably more) from a well located upgradient from the plume. ORP measurements should be taken during well purging and immediately before and after sample acquisition using a direct-reading meter. Because most well purging techniques can allow aeration of collected ground-water samples (which can affect ORP measurements), it is important to minimize potential aeration by using a flow-through cell as outlined in Appendix A.

Most discussion of oxidation reduction potential expresses the potential as if it were measured against the standard hydrogen electrode. Most electrodes and meters to measure oxidation-reduction potential use the silver/silver chloride electrode (Ag/AgCl) as the reference electrode. This protocol uses the potential against the Ag/AgCl electrode as the screening potential, not Eh as would be measured against the standard hydrogen electrode.

2.3.2.9 Dissolved Hydrogen

In some ground waters, PCE and TCE appear to attenuate, although significant concentrations of DCE and VC do not accumulate. In this situation, it is difficult to distinguish between Type 3 behavior where the daughter products are not produced, and Type 1 or Type 2 behavior where the daughter products are removed very rapidly. In cases like this, the concentration of hydrogen can be used to identify ground waters where reductive dechlorination is occurring. If hydrogen concentrations are very low, reductive dechlorination is not efficient and Type 3 behavior is indicated. If hydrogen concentrations are greater than approximately 1 nM, rates of reductive dechlorination should have environmental significance and Type 1 or Type 2 behavior would be expected.

Concentrations of dissolved hydrogen have been used to evaluate redox processes, and thus the efficiency of reductive dechlorination, in ground-water systems (Lovley and Goodwin, 1988; Lovley *et al.*, 1994; Chapelle *et al.*, 1995). Dissolved hydrogen is continuously produced in anoxic ground-water systems by fermentative microorganisms that decompose natural and anthropogenic organic matter. This H₂ is then consumed by respiratory microorganisms that use nitrate, Fe(III), sulfate, or CO₂ as terminal electron acceptors. This continuous cycling of H₂ is called *interspecies hydrogen transfer*. Significantly, nitrate-, Fe(III)-, sulfate- and CO₂-reducing (methanogenic) microorganisms exhibit different efficiencies in utilizing the H₂ that is being continually produced. Nitrate reducers are highly efficient H₂ utilizers and maintain very low steady-state H₂ concentrations. Fe(III) reducers are slightly less efficient and thus maintain somewhat higher H₂ concentrations. Sulfate reducers and methanogenic bacteria are progressively less efficient and maintain even higher H₂ concentrations. Because each terminal electron accepting process has a characteristic H₂ concentration associated with it, H₂ concentrations can be an indicator of predominant redox

processes. These characteristic ranges are given in Table 2.5. An analytical protocol for quantifying H₂ concentrations in ground water is given in Appendix A.

Table 2.5 Range of Hydrogen Concentrations for a Given Terminal Electron-Accepting Process

Terminal Electron Accepting Process	Hydrogen (H₂) Concentration (nanomoles per liter)
Denitrification	< 0.1
Iron (III) Reduction	0.2 to 0.8
Sulfate Reduction	1 to 4
Reductive Dechlorination	>1
Methanogenesis	5-20

Oxidation-reduction potential (ORP) measurements are based on the concept of thermodynamic equilibrium and, within the constraints of that assumption, can be used to evaluate redox processes in ground water systems. The H₂ method is based on the ecological concept of interspecies hydrogen transfer by microorganisms and, within the constraints of that assumption, can also be used to evaluate redox processes. These methods, therefore, are fundamentally different. A direct comparison of these methods (Chapelle et al., 1996) has shown that ORP measurements were effective in delineating oxic from anoxic ground water, but that ORP measurements could not distinguish between nitrate-reducing, Fe(III)-reducing, sulfate-reducing, or methanogenic zones in an aquifer. In contrast, the H₂ method could readily distinguish between different anaerobic zones. For those sites where distinguishing between different anaerobic processes is important, H₂ measurements are an available technology for making such distinctions. At sites where concentrations of redox sensitive parameters such as dissolved oxygen, iron (II), sulfide, and methane are sufficient to identify operative redox processes, H₂ concentrations are not always required to identify redox zonation and predict contaminant behavior.

In practice, it is preferable to interpret H₂ concentrations in the context of electron acceptor availability and the presence of the final products of microbial metabolism (Chapelle *et al.*, 1995). For example, if sulfate concentrations in ground water are less than 0.5 mg/L, methane concentrations are greater than 0.5 mg/L, and H₂ concentrations are in the 5 to 20 nM range, it can be concluded with a high degree of certainty that methanogenesis is the predominant redox process in the aquifer. Similar logic can be applied to identifying denitrification (presence of nitrate, H₂<0.1 nM), Fe(III) reduction (production of Fe(II), H₂ concentrations ranging from 0.2 to 0.8 nM), and sulfate reduction (presence of sulfate, production of sulfide, H₂ concentrations ranging from 1 to 4 nM). Reductive dechlorination in the field has been documented at hydrogen concentrations that support sulfate reduction or methanogenesis. If hydrogen concentrations are high enough to support sulfate reduction or methanogenesis, then reductive dechlorination is probably occurring, even if other geochemical indicators as scored in Table 2.3 do not indicate that reductive dechlorination is possible.

2.3.2.10 pH, Temperature, and Conductivity

Because the pH, temperature, and conductivity of a ground-water sample can change significantly within a short time following sample acquisition, these parameters must be measured in the field in unfiltered, unpreserved, “fresh” water collected by the same technique as the samples taken for dissolved oxygen and ORP analyses. The measurements should be made in a clean

container separate from those intended for laboratory analysis, and the measured values should be recorded in the ground-water sampling record.

The pH of ground water has an effect on the presence and activity of microbial populations in ground water. This is especially true for methanogens. Microbes capable of degrading chlorinated aliphatic hydrocarbons and petroleum hydrocarbon compounds generally prefer pH values varying from 6 to 8 standard units.

Ground-water temperature directly affects the solubility of dissolved gasses and other geochemical species. Ground-water temperature also affects the metabolic activity of bacteria.

Conductivity is a measure of the ability of a solution to conduct electricity. The conductivity of ground water is directly related to the concentration of ions in solution; conductivity increases as ion concentration increases.

2.3.2.11 Chloride

Chlorine is the most abundant of the halogens. Although chlorine can occur in oxidation states ranging from Cl^- to Cl^{+7} , the chloride form (Cl^-) is the only form of major significance in natural waters (Hem, 1985). Chloride forms ion pairs or complex ions with some of the cations present in natural waters, but these complexes are not strong enough to be of significance in the chemistry of fresh water (Hem, 1985). Chloride ions generally do not enter into oxidation-reduction reactions, form no important solute complexes with other ions unless the chloride concentration is extremely high, do not form salts of low solubility, are not significantly adsorbed on mineral surfaces, and play few vital biochemical roles (Hem, 1985). Thus, physical processes control the migration of chloride ions in the subsurface. Kaufman and Orlob (1956) conducted tracer experiments in ground water, and found that chloride moved through most of the soils tested more conservatively (i.e., with less retardation and loss) than any of the other tracers tested.

During biodegradation of chlorinated hydrocarbons dissolved in ground water, chloride is released into the ground water. This results in chloride concentrations in ground water in the contaminant plume that are elevated relative to background concentrations. Because of the neutral chemical behavior of chloride, it can be used as a conservative tracer to estimate biodegradation rates, as discussed in Appendix C.

2.3.3 Aquifer Parameter Estimation

Estimates of aquifer parameters are necessary to accurately evaluate contaminant fate and transport.

2.3.3.1 Hydraulic Conductivity

Hydraulic conductivity is a measure of an aquifer's ability to transmit water, and is perhaps the most important aquifer parameter governing fluid flow in the subsurface. The velocity of ground water and dissolved contamination is directly related to the hydraulic conductivity of the saturated zone. In addition, subsurface variations in hydraulic conductivity directly influence contaminant fate and transport by providing preferential paths for contaminant migration. Estimates of hydraulic conductivity are used to determine residence times for contaminants and tracers, and to determine the seepage velocity of ground water.

The most common methods used to quantify hydraulic conductivity are aquifer pumping tests and slug tests (Appendix A). Another method that may be used to determine hydraulic conductivity is the borehole dilution test. One drawback to these methods is that they average hydraulic properties over the screened interval. To help alleviate this potential problem, the screened interval of the test wells should be selected after consideration is given to subsurface stratigraphy.

Information about subsurface stratigraphy should come from geologic logs of continuous cores or from cone penetrometer tests. The rate of filling of a Hydropunch® can be used to obtain a rough estimate of the local hydraulic conductivity at the same time the water sample is collected. The results of pressure dissipation data from cone penetrometer tests can be used to supplement the results obtained from pumping tests and slug tests. It is important that the location of the aquifer tests be designed to collect information to delineate the range of hydraulic conductivity both vertically and horizontally at the site.

2.3.3.1.1 Pumping Tests in Wells

Pumping tests done in wells provide information on the average hydraulic conductivity of the screened interval, but not the most transmissive horizon included in the screened interval. In contaminated areas, the extracted ground water generally must be collected and treated, increasing the difficulty of such testing. In addition, a minimum 4-inch-diameter well is typically required to complete pumping tests in highly transmissive aquifers because the 2-inch submersible pumps available today are not capable of producing a flow rate high enough for meaningful pumping tests. In areas with fairly uniform aquifer materials, pumping tests can be completed in uncontaminated areas, and the results can be used to estimate hydraulic conductivity in the contaminated area. Pumping tests should be conducted in wells that are screened in the most transmissive zones in the aquifer. If pumping tests are conducted in wells with more than fifteen feet of screen, a down-hole flowmeter test can be used to determine the interval actually contributing to flow.

2.3.3.1.2 Slug Tests in Wells

Slug tests are a commonly used alternative to pumping tests. One commonly cited drawback to slug testing is that this method generally gives hydraulic conductivity information only for the area immediately surrounding the monitoring well. Slug tests do, however, have two distinct advantages over pumping tests: they can be conducted in 2-inch monitoring wells, and they produce no water. If slug tests are going to be relied upon to provide information on the three-dimensional distribution of hydraulic conductivity in an aquifer, multiple slug tests must be performed. It is not advisable to rely on data from one slug test in one monitoring well. Because of this, slug tests should be conducted at several zones across the site, including a test in at least two wells which are narrowly screened in the most transmissive zone. There should also be tests in the less transmissive zones to provide an estimate of the range of values present on the site.

2.3.3.1.3 Downhole Flowmeter

Borehole flowmeter tests are conducted to investigate the relative vertical distribution of horizontal hydraulic conductivity in the screened interval of a well or the uncased portion of a borehole. These tests can be done to identify any preferential flow pathways within the portion of an aquifer intersecting the test well screen or the open borehole. The work of Molz and Young (1993), Molz *et al.* (1994), Young and Pearson (1995), and Young (1995) describes the means by which these tests may be conducted and interpreted.

In general, measurements of ambient ground-water flow rates are collected at several regularly spaced locations along the screened interval of a well. Next, the well is pumped at a steady rate, and the measurements are repeated. The test data may be analyzed using the methods described by Molz and Young (1993) and Molz *et al.* (1994) to define the relative distribution of horizontal hydraulic conductivity within the screened interval of the test well. Estimates of bulk hydraulic conductivity from previous aquifer tests can be used to estimate the absolute hydraulic conductivity distribution at the test well.

Using flowmeter test data, one may be able to more thoroughly quantify the three-dimensional hydraulic conductivity distribution at a site. This is important for defining contaminant migration pathways and understanding solute transport at sites with heterogeneous aquifers. Even at sites where the hydrogeology appears relatively homogeneous, such data may point out previously undetected zones or layers of higher hydraulic conductivity that control contaminant migration. In addition, ground-water velocities calculated from hydraulic head, porosity, and hydraulic conductivity data may be used to evaluate site data or for simple transport calculations. In these cases, it is also important to have the best estimate possible of hydraulic conductivity for those units in which the contaminants are migrating.

2.3.3.2 Hydraulic Gradient

The horizontal hydraulic gradient is the change in hydraulic head (feet of water) divided by the distance of ground-water flow between head measurement points. To accurately determine the hydraulic gradient, it is necessary to measure ground-water levels in all monitoring wells and piezometers at a site. Because hydraulic gradients can change over a short distance within an aquifer, it is essential to have as much site-specific ground-water elevation information as possible so that accurate hydraulic gradient calculations can be made. In addition, seasonal variations in ground-water flow direction can have a profound influence on contaminant transport. Sites in upland areas are less likely to be affected by seasonal variations in ground-water flow direction than low-elevation sites situated near surface water bodies such as rivers and lakes.

To determine the effect of seasonal variations in ground-water flow direction on contaminant transport, quarterly ground-water level measurements should be taken over a period of at least one year. For many sites, these data may already exist. If hydraulic gradient data over a one-year period are not available, natural attenuation can still be implemented, pending an analysis of seasonal variation in ground-water flow direction.

2.3.3.3 Processes Causing an Apparent Reduction in Total Contaminant Mass

Several processes cause reductions in contaminant concentrations and apparent reductions in the total mass of contaminant in a system. Processes causing apparent reductions in contaminant mass include dilution, sorption, and hydrodynamic dispersion. In order to determine the mass of contaminant removed from the system, it is necessary to correct observed concentrations for the effects of these processes. This is done by incorporating independent assessments of these processes into the comprehensive solute transport model. The following sections give a brief overview of the processes that result in apparent contaminant reduction. Appendix B describes these processes in detail.

Dilution results in a reduction in contaminant concentrations and an apparent reduction in the total mass of contaminant in a system due to the introduction of additional water to the system. The two most common causes of dilution (real or apparent) are infiltration and sampling from monitoring wells screened over large vertical intervals. Infiltration can cause an apparent reduction in contaminant mass by mixing unaffected waters with the contaminant plume, thereby causing dilution. Monitoring wells screened over large vertical distances may dilute ground-water samples by mixing water from clean aquifer zones with contaminated water during sampling. To avoid potential dilution during sampling, monitoring wells should be screened over relatively small vertical intervals (e.g. 5 feet). Nested wells should be used to define the vertical extent of contamination in the saturated zone. Appendix C contains example calculations showing how to correct for the effects of dilution.

The retardation of organic solutes caused by sorption is an important consideration when simulating the effects of natural attenuation over time. Sorption of a contaminant to the aquifer matrix results in an apparent decrease in contaminant mass because dissolved contamination is removed from the aqueous phase. The processes of contaminant sorption and retardation are discussed in Appendix B.

The dispersion of organic solutes in an aquifer is another important consideration when simulating natural attenuation. The dispersion of a contaminant into relatively pristine portions of the aquifer allows the solute plume to mix with uncontaminated ground water containing higher concentrations of electron acceptors. Dispersion occurs vertically as well as parallel and perpendicular to the direction of ground-water flow.

To accurately determine the mass of contaminant transformed to innocuous by-products, it is important to correct measured contaminant concentrations for those processes that cause an apparent reduction in contaminant mass. This is accomplished by normalizing the measured concentration of each of the contaminants to the concentration of a tracer that is biologically recalcitrant. Because chloride is produced during the biodegradation of chlorinated solvents, this analyte can be used as a tracer. For chlorinated solvents undergoing reductive dechlorination, it is also possible to use the organic carbon in the original chlorinated solvent and daughter products as a tracer. Trimethylbenzene and tetramethylbenzene are two chemicals found in fuel hydrocarbon plumes that also may be useful as tracers. These compounds are difficult to biologically degrade under anaerobic conditions, and frequently persist in ground water longer than BTEX. Depending on the composition of the fuel that was released, other tracers may be used.

2.3.4 Optional Confirmation of Biological Activity

Extensive evidence can be found in the literature showing that biodegradation of chlorinated solvents and fuel hydrocarbons frequently occurs under natural conditions. Many references from the large body of literature in support of natural attenuation are listed in Section 3 and discussed in Appendix B. The most common technique used to show explicitly that microorganisms capable of degrading contaminants are present at a site is the microcosm study.

If additional evidence (beyond contaminant and geochemical data and supporting calculations) supporting natural attenuation is required, a microcosm study using site-specific aquifer materials and contaminants can be undertaken.

If properly designed, implemented, and interpreted, microcosm studies can provide very convincing documentation of the occurrence of biodegradation. Results of such studies are strongly influenced by the nature of the geological material submitted for study, the physical properties of the microcosm, the sampling strategy, and the duration of the study. Because microcosm studies are time-consuming and expensive, they should be undertaken only at sites where there is considerable uncertainty concerning the biodegradation of contaminants.

Biodegradation rate constants determined by microcosm studies often are higher than rates achieved in the field. The collection of material for the microcosm study, the procedures used to set up and analyze the microcosm, and the interpretation of the results of the microcosm study are presented in Appendix C.

2.4 REFINE CONCEPTUAL MODEL, COMPLETE PRE-MODELING CALCULATIONS, AND DOCUMENT INDICATORS OF NATURAL ATTENUATION

Site investigation data should first be used to refine the conceptual model and quantify ground-water flow, sorption, dilution, and biodegradation. The results of these calculations are used to scientifically document the occurrence and rates of natural attenuation and to help simulate natural

attenuation over time. It is the responsibility of the proponent to “make the case” for natural attenuation. This being the case, all available data must be integrated in such a way that the evidence is sufficient to support the conclusion that natural attenuation is occurring.

2.4.1 Conceptual Model Refinement

Conceptual model refinement involves integrating newly gathered site characterization data to refine the preliminary conceptual model that was developed on the basis of previously collected site-specific data. During conceptual model refinement, all available site-specific data should be integrated to develop an accurate three-dimensional representation of the hydrogeologic and contaminant transport system. This refined conceptual model can then be used for contaminant fate and transport modeling. Conceptual model refinement consists of several steps, including preparation of geologic logs, hydrogeologic sections, potentiometric surface/water table maps, contaminant and daughter product contour (isopleth) maps, and electron acceptor and metabolic by-product contour (isopleth) maps.

2.4.1.1 Geologic Logs

Geologic logs of all subsurface materials encountered during the soil boring phase of the field work should be constructed. Descriptions of the aquifer matrix should include relative density, color, major and minor minerals, porosity, relative moisture content, plasticity of fines, cohesiveness, grain size, structure or stratification, relative permeability, and any other significant observations such as visible contaminants or contaminant odor. It is also important to correlate the results of VOC screening using soil sample headspace vapor analysis with depth intervals of geologic materials. The depth of lithologic contacts and/or significant textural changes should be recorded to the nearest 0.1 foot. This resolution is necessary because preferential flow and contaminant transport paths may be limited to thin stratigraphic units.

2.4.1.2 Cone Penetrometer Logs

Cone Penetrometer Logs provide a valuable tool for the rapid collection of large amounts of stratigraphic information. When combined with the necessary corroborative physical soil samples from each stratigraphic unit occurring on the site, they can provide a three-dimensional model of subsurface stratigraphy.

Cone penetrometer logs express stratigraphic information as the ratio of sleeve friction to tip pressure. Cone penetrometer logs also may contain fluid resistivity data and estimates of aquifer hydraulic conductivity. To provide meaningful data, the cone penetrometer must be capable of providing stratigraphic resolution on the order of 3 inches. To provide accurate stratigraphic information, cone penetrometer logs must be correlated with continuous subsurface cores. At a minimum, there must be one correlation for every hydrostratigraphic unit found at the site. Cone penetrometer logs, along with geologic boring logs, can be used to complete the hydrogeologic sections discussed in Section 2.4.1.3.

2.4.1.3 Hydrogeologic Sections

Hydrogeologic sections should be prepared from boring logs and/or CPT data. A minimum of two hydrogeologic sections are required; one parallel to the direction of ground-water flow and one perpendicular to the direction of ground water flow. More complex sites may require more hydrogeologic sections. Hydraulic head data including potentiometric surface and/or water table elevation data should be plotted on the hydrogeologic section. These sections are useful in identifying potential pathways of contaminant migration, including preferential pathways of NAPL migration (e.g., surface topography and dip of confining layers) and of aqueous contaminants (e.g., highly

transmissive layers). The potential distribution NAPL sources as well as preferential pathways for solute transport should be considered when simulating contaminant transport using fate and transport models.

2.4.1.4 Potentiometric Surface or Water Table Map(s)

A potentiometric surface or water table map is a two-dimensional graphic representation of equipotential lines shown in plan view. These maps should be prepared from water level measurements and surveyor's data. Because ground water flows from areas of higher hydraulic head to areas of lower hydraulic head, such maps are used to estimate the probable direction of plume migration and to calculate hydraulic gradients. These maps should be prepared using water levels measured in wells screened in the same relative position within the same hydrogeologic unit. To determine vertical hydraulic gradients, separate potentiometric maps should be developed for different horizons in the aquifer to document vertical variations in ground-water flow. Flow nets should also be constructed to document vertical variations in ground-water flow. To document seasonal variations in ground-water flow, separate potentiometric surface or water table maps should be prepared for quarterly water level measurements taken over a period of at least one year. In areas with mobile LNAPL, a correction must be made for the water table deflection caused by accumulation of the LNAPL in the well. This correction and potentiometric surface map preparation are discussed in Appendix C.

2.4.1.5 Contaminant and Daughter Product Contour Maps

Contaminant and daughter product contour maps should be prepared for all contaminants present at the site for each discrete sampling event. Such maps allow interpretation of data on the distribution and the relative transport and degradation rates of contaminants in the subsurface. In addition, contaminant contour maps are necessary so that contaminant concentrations can be gridded and used for input into a numerical model. Detection of daughter products not present in the released NAPL (e.g., *cis*-1,2-DCE, VC, or ethene) provides evidence of reductive dechlorination. Preparation of contaminant isopleth maps is discussed in Appendix C.

If mobile and residual NAPLs are present at the site, a contour map showing the thickness and vertical and horizontal distribution of each should be prepared. These maps will allow interpretation of the distribution and the relative transport rate of NAPLs in the subsurface. In addition, these maps will aid in partitioning calculations and solute fate and transport model development. It is important to note that, because of the differences between the magnitude of capillary suction in the aquifer matrix and the different surface tension properties of NAPL and water, NAPL thickness observations made at monitoring points may not provide an accurate estimate of the actual volume of mobile and residual NAPL in the aquifer. To accurately determine the distribution of NAPLs, it is necessary to take continuous soil cores or, if confident that chlorinated solvents present as NAPL are commingled with fuels, to use cone penetrometer testing coupled with laser-induced fluorescence. Appendix C discusses the relationship between actual and apparent NAPL thickness.

2.4.1.6 Electron Acceptor, Metabolic By-product, and Alkalinity Contour Maps

Contour maps should be prepared for electron acceptors consumed (dissolved oxygen, nitrate, and sulfate) and metabolic by-products produced [iron (II), chloride, and methane] during biodegradation. In addition, a contour map should be prepared for alkalinity and ORP. The electron acceptor, metabolic by-product, alkalinity, and ORP contour maps provide evidence of the occurrence of biodegradation at a site. If hydrogen data are available, they also should be contoured.

During aerobic biodegradation, dissolved oxygen concentrations will decrease to levels below background concentrations. Similarly, during anaerobic degradation, the concentrations of nitrate and sulfate will be seen to decrease to levels below background. The electron acceptor contour maps allow interpretation of data on the distribution of the electron acceptors and the relative transport and degradation rates of contaminants in the subsurface. Thus, electron acceptor contour maps provide visual evidence of biodegradation and a visual indication of the relationship between the contaminant plume and the various electron acceptors.

Contour maps should be prepared for iron (II), chloride, and methane. During anaerobic degradation, the concentrations of these parameters will be seen to increase to levels above background. These maps allow interpretation of data on the distribution of metabolic by-products resulting from the microbial degradation of fuel hydrocarbons and the relative transport and degradation rates of contaminants in the subsurface. Thus, metabolic by-product contour maps provide visual evidence of biodegradation and a visual indication of the relationship between the contaminant plume and the various metabolic by-products.

A contour map should be prepared for total alkalinity (as CaCO_3). Respiration of dissolved oxygen, nitrate, iron (III), and sulfate tends to increase the total alkalinity of ground water. Thus, the total alkalinity inside the contaminant plume generally increases to levels above background. This map will allow visual interpretation of alkalinity data by showing the relationship between the contaminant plume and elevated alkalinity.

2.4.2 Pre-Modeling Calculations

Several calculations must be made prior to implementation of the solute fate and transport model. These calculations include sorption and retardation calculations, NAPL/water partitioning calculations, ground-water flow velocity calculations, and biodegradation rate-constant calculations. Each of these calculations is discussed in the following sections. The specifics of each calculation are presented in the appendices referenced below.

2.4.2.1 Analysis of Contaminant, Daughter Product, Electron Acceptor, Metabolic By-product, and Total Alkalinity Data

The extent and distribution (vertical and horizontal) of contamination, daughter product, and electron acceptor and metabolic by-product concentrations are of paramount importance in documenting the occurrence of biodegradation and in solute fate and transport model implementation.

Comparison of contaminant, electron acceptor, electron donor, and metabolic by-product distributions can help identify significant trends in site biodegradation. Dissolved oxygen concentrations below background in an area with organic contamination are indicative of aerobic biodegradation of organic carbon. Similarly, nitrate and sulfate concentrations below background in an area with contamination are indicative of anaerobic biodegradation of organic carbon. Likewise, elevated concentrations of the metabolic by-products iron (II), chloride, and methane in areas with contamination are indicative of biodegradation of organic carbon. In addition, elevated concentrations of total alkalinity (as CaCO_3) in areas with contamination are indicative of biodegradation of organic compounds via aerobic respiration, denitrification, iron (III) reduction, and sulfate reduction. If these trends can be documented, it is possible to quantify the relative importance of each biodegradation mechanism, as described in Appendices B and C. The contour maps described in Section 2.4.1 can be used to provide graphical evidence of these relationships.

Detection of daughter products not present in the released NAPL (e.g., *cis*-1,2-DCE, VC, or ethene) provides evidence of reductive dechlorination. The contour maps described in Section 2.4.1 in conjunction with NAPL analyses can be used to show that reductive dechlorination is occurring.

2.4.2.2 Sorption and Retardation Calculations

Contaminant sorption and retardation calculations should be made based on the TOC content of the aquifer matrix and the organic carbon partitioning coefficient (K_{oc}) for each contaminant. The average TOC concentration from the most transmissive zone in the aquifer should be used for retardation calculations. A sensitivity analysis should also be performed during modeling using a range of TOC concentrations, including the lowest TOC concentration measured at the site. Sorption and retardation calculations should be completed for all contaminants and any tracers. Sorption and retardation calculations are described in Appendix C.

2.4.2.3 NAPL/Water Partitioning Calculations

If NAPL remains at the site, partitioning calculations should be made to account for the partitioning from this phase into ground water. Several models for NAPL/water partitioning have been proposed in recent years, including those by Hunt *et al.* (1988), Bruce *et al.* (1991), Cline *et al.* (1991), and Johnson and Pankow (1992). Because the models presented by Cline *et al.* (1991) and Bruce *et al.* (1991) represent equilibrium partitioning, they are the most conservative models. Equilibrium partitioning is conservative because it predicts the maximum dissolved concentration when NAPL in contact with water is allowed to reach equilibrium. The results of these equilibrium partitioning calculations can be used in a solute fate and transport model to simulate a continuing source of contamination. The theory behind fuel/water partitioning calculations is presented in Appendix B, and example calculations are presented in Appendix C.

2.4.2.4 Ground-water Flow Velocity Calculations

The average linear ground-water flow velocity of the most transmissive aquifer zone containing contamination should be calculated to check the accuracy of the solute fate and transport model and to allow calculation of first-order biodegradation rate constants. An example of a ground-water flow velocity calculation is given in Appendix C.

2.4.2.5 Apparent Biodegradation Rate-Constant Calculations

Biodegradation rate constants are necessary to accurately simulate the fate and transport of contaminants dissolved in ground water. In many cases, biodegradation of contaminants can be approximated using first-order kinetics. In order to calculate first-order biodegradation rate constants, the apparent degradation rate must be normalized for the effects of dilution, sorption, and volatilization. Two methods for determining first-order rate constants are described in Appendix C. One method involves the use of a biologically recalcitrant compound found in the dissolved contaminant plume that can be used as a conservative tracer. The other method, proposed by Buscheck and Alcantar (1995) is based on the one-dimensional steady-state analytical solution to the advection-dispersion equation presented by Bear (1979). It is appropriate for plumes where contaminant concentrations are in dynamic equilibrium between plume formation at the source and plume attenuation downgradient. Because of the complexity of estimating biodegradation rates with these methods, the results are more accurately referred to as “apparent” biodegradation rate constants. Apparent degradation rates reflect the difference between contaminant degradation and production which is important for some daughter products (e.g., TCE, DCE, and VC).

2.5 SIMULATE NATURAL ATTENUATION USING SOLUTE FATE AND TRANSPORT MODELS

Simulating natural attenuation allows prediction of the migration and attenuation of the contaminant plume through time. Natural attenuation modeling is a tool that allows site-specific data to be used to predict the fate and transport of solutes under governing physical, chemical, and

biological processes. Hence, the results of the modeling effort are not in themselves sufficient proof that natural attenuation is occurring at a given site. The results of the modeling effort are only as good as the original data input into the model; therefore, an investment in thorough site characterization will improve the validity of the modeling results. In some cases, straightforward analytical models of solute transport are adequate to simulate natural attenuation.

Several well-documented and widely accepted solute fate and transport models are available for simulating the fate and transport of contaminants under the influence of advection, dispersion, sorption, and biodegradation.

2.6 CONDUCT A RECEPTOR EXPOSURE PATHWAYS ANALYSIS

After the rates of natural attenuation have been documented, and predictions from appropriate fate and transport models indicate that MNA is a viable remedy, the proponent of natural attenuation should combine all available data and information to provide support for this remedial option. Supporting the natural attenuation option generally will involve performing a receptor exposure pathways analysis. This analysis includes identifying potential human and ecological receptors and points of exposure under current and future land and ground-water use scenarios. The results of solute fate and transport modeling are central to the exposure pathways analysis. If conservative model input parameters are used, the solute fate and transport model should give conservative estimates of contaminant plume migration. From this information, the potential for impacts on human health and the environment from contamination present at the site can be assessed.

2.7 EVALUATE SUPPLEMENTAL SOURCE REMOVAL OPTIONS

Additional source removal, treatment, or containment measures, beyond those previously implemented, may be necessary for MNA to be a viable remedial option or to decrease the time needed for natural processes to attain site-specific remedial objectives. Several technologies suitable for source reduction or removal are listed on Figure 2.1. Other technologies may be used as dictated by site conditions and regulatory requirements. If a solute fate and transport model has been prepared for a site, the impact of source removal can readily be evaluated by modifying the contaminant source term; this will allow for a reevaluation of the exposure pathways analysis.

In some cases (particularly if the site is regulated under CERCLA), the removal, treatment, or containment of the source may be required to restore the aquifer as a source of drinking water, or to prevent discharge of contaminants to ecologically sensitive areas. If a solute fate and transport model has been prepared, it can also be used to forecast the benefits of source control by predicting the time required to restore the aquifer to drinking water quality, and the reduction in contaminant loadings to sensitive ecosystems.

2.8 PREPARE LONG-TERM MONITORING PLAN

This plan is used to monitor the plume over time and to verify that natural attenuation is occurring at rates sufficient to attain site-specific remediation objectives and within the time frame predicted at the time of remedy selection. In addition, the long-term monitoring plan should be designed to evaluate long-term behavior of the plume, verify that exposure to contaminants does not occur, verify that natural attenuation breakdown products do not pose additional risks, determine actual (rather than predicted) attenuation rates for refining predictions of remediation time frame, and to document when site-specific remediation objectives have been attained.

The long-term monitoring plan should be developed based on site characterization data, analysis of potential exposure pathways, and the results of solute fate and transport modeling. EPA is developing additional guidance on long-term monitoring of MNA remedies, which should be consulted when available.

The long-term monitoring plan includes two types of monitoring wells. Long-term monitoring wells are intended to determine if the behavior of the plume is changing. Performance evaluation wells are intended to confirm that contaminant concentrations meet regulatory acceptance levels, and to trigger an action to manage potential expansion of the plume. Figure 2.7 depicts a schematic that describes the various categories of wells in a comprehensive monitoring plan. Figure 2.7 is intended to depict categories of wells, and does not depict monitoring well placement at a real site. Included in the schematic representation are: 1) wells in the source area; 2) wells in unimpacted ground water; 3) wells downgradient of the source area in a zone of natural attenuation; 4) wells located downgradient from the plume where contaminant concentrations are below regulatory acceptance levels but geochemical indicators are altered and soluble electron acceptors are depleted with respect to unimpacted ground water; and 5) performance evaluation wells.

The final number and placement of long-term monitoring wells and performance evaluation wells will vary from site to site, based on the behavior of the plume as revealed during the site characterization and on the site-specific remediation objectives. In order to provide a valid monitoring system, all monitoring wells must be screened in the same hydrogeologic unit as the contaminant plume being monitored. This generally requires detailed stratigraphic correlation. To facilitate accurate stratigraphic correlation, detailed visual descriptions of all subsurface materials encountered during borehole drilling or cone penetrometer testing should be prepared prior to monitoring well installation.

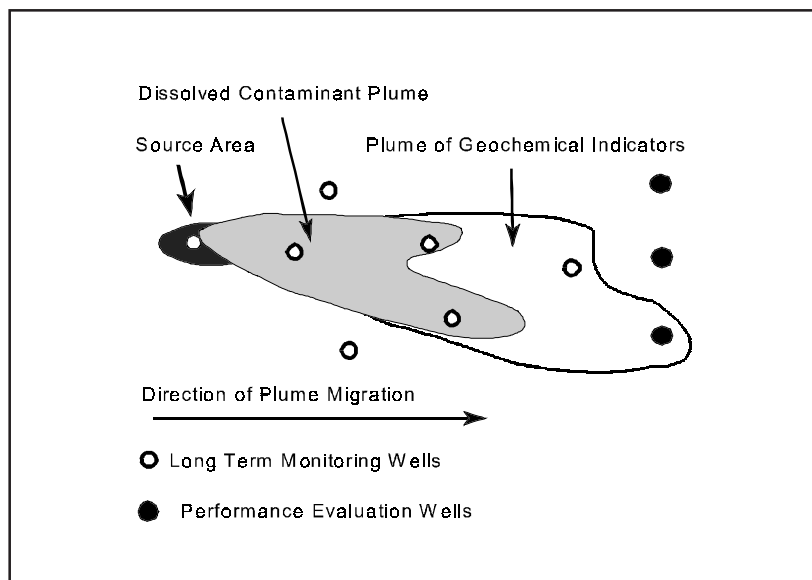

Figure 2.7 Hypothetical long-term monitoring strategy. Note that number and location of monitoring wells will vary with the three-dimensional complexity of the plume(s) and site-specific remediation objectives.

Although the final number and placement of long-term monitoring wells and performance evaluation wells should be determined through regulatory negotiation, the locations of long-term monitoring wells should be based on the behavior of the plume as revealed during the site characterization and on regulatory considerations. The final number and location of performance evaluation wells will also depend on regulatory considerations.

A ground-water sampling and analysis plan should be prepared in conjunction with a plan for placement of performance evaluation wells and long-term monitoring wells. For purposes of monitoring natural attenuation of chlorinated solvents, ground water from the long-term monitoring wells should be analyzed for the contaminants of concern, dissolved oxygen, nitrate, iron (II), sulfate, and methane. For performance evaluation wells, ground-water analyses should be limited to contaminants of concern. Any additional specific analytical requirements, such as sampling for contaminants that are metals, should be addressed in the sampling and analysis plan to ensure that all data required for regulatory decision making are collected. Water level and NAPL thickness measurements should be made during each sampling event.

Except at sites with very low hydraulic conductivity and gradients, quarterly sampling of both long-term monitoring wells and performance evaluation wells is recommended during the first year to help determine whether the plume is stable or migrating, the direction of plume migration and to establish a baseline for behavior of the plume. After the first year, an appropriate sampling frequency should be established which considers seasonal variations in water table elevations, ground-water flow direction and flow velocity at the site. If the hydraulic conductivity or hydraulic gradient are low, the time required for ground water to move from upgradient monitoring wells to downgradient monitoring wells should also be considered in determining the appropriate monitoring frequency. Monitoring of long-term performance of an MNA remedy should continue as long as contamination remains above required cleanup levels.

2.9 PRESENT FINDINGS

Results of natural attenuation studies should be presented in the remedy selection document appropriate for the site, such as CERCLA Feasibility Study or RCRA Corrective Measures Study. This will provide scientific documentation that allows an objective evaluation of whether MNA is the most appropriate remedial option for a given site.

All available site-specific data and information developed during the site characterization, conceptual model development, pre-modeling calculations, biodegradation rate calculation, ground-water modeling, model documentation, and long-term monitoring plan preparation phases of the natural attenuation investigation should be presented in a consistent and complementary manner in the feasibility study or similar document. Of particular interest to the site decision makers will be evidence that natural attenuation is occurring at rates sufficient to attain site-specific remediation objectives in a time period that is reasonable compared to other alternatives, and that human health and the environment will be protected over time. Since a weight-of-evidence argument will be presented to support an MNA remedy, all model assumptions should be conservative and all available evidence in support of MNA should be presented.

SECTION 3

REFERENCES

- Abdul, A.S., Kia, S.F., and Gibson, T.L., 1989, Limitations of monitoring wells for the detection and quantification of petroleum products in soils and aquifers: *Ground Water Monit. Rev.*, Spring, 1989, p. 90-99.
- Abriola, L.M., and Pinder, G.F., 1985a, A multiphase approach to the modeling of porous media contamination by organic compounds: 1. Equation development: *Water Resour. Res.*, 21:11-18.
- Abriola, L.M., and Pinder, G.F., 1985b, A multiphase approach to the modeling of porous media contamination by organic compounds: 2. Numerical Simulation: *Water Resour. Res.*, 21:19-28.
- Abriola, L.M., 1996, Organic liquid contaminant entrapment and persistence in the subsurface: Interphase mass transfer limitation and implications for remediation: 1996 Darcy Lecture, National Ground Water Association, presented at Colorado School of Mines, October 25, 1996.
- Acton, D.W., 1990, Enhanced *in situ* biodegradation of aromatic and chlorinated aliphatic hydrocarbons in anaerobic, leachate-impacted groundwaters: M.Sc. Thesis, University of Waterloo, Waterloo, Ontario.
- Adriaens, P., and Vogel, T.M., 1995, Biological treatment of chlorinated organics, *In Microbial Transformation and Degradation of Toxic Organic Chemicals*: (Young, L.Y., and Cerniglia, C.E., Eds.,) Wiley-Liss, New York, 654 p.
- AFCEE, 1995, Free Product Recovery Protocol, Rev. 2: U.S. Air Force Center for Environmental Excellence, Brooks Air Force Base, TX.
- Air Force Center for Environmental Excellence, 1994, Addendum 1 to the Test Plan and Technical Protocol for a Field Treatability Test for Bioventing.
- Alvarez-Cohen, L.M. and McCarty, P.L., 1991a, Effects of toxicity, aeration, and reductant supply on trichloroethylene transformation by a mixed methanotrophic culture: *Appl. Environ. Microbiol.*, 57(1):228-235.
- Alvarez-Cohen, L.M., and McCarty, P.L., 1991b, Product toxicity and cometabolic competitive inhibition modeling of chloroform and trichloroethylene transformation by methanotrophic resting cells: *Appl. Environ. Microbiol.*, 57(4):1031-1037.
- Alvarez, P.J.J., and Vogel, T.M., 1991, Substrate interactions of benzene, toluene, and paraxylene during microbial degradation by pure cultures and mixed culture aquifer slurries: *Appl. Environ. Microbiol.*, 57:2981-2985.
- American Petroleum Institute, 1985, Laboratory Study on Solubilities of Petroleum Hydrocarbons in Groundwater: American Petroleum Institute, Publication Number 4395.
- Anderson, M.P., 1979, Using models to simulate the movement of contaminants through groundwater flow systems: *CRC Crit. Rev. Environ. Control*, 9:97-156.
- Anderson, M.P., and Woessner, W.W., 1992, *Applied Groundwater Modeling - Simulation of Flow and Advective Transport*: Academic Press, New York, 381 p.
- Arciero, D., Vannelli, T., Logan, M., and Hooper, A.B., 1989, Degradation of trichloroethylene by the ammonia-oxidizing bacterium *Nitrosomonas europaea*: *Biochem. Biophys. Res. Commun.*, 159:640-643.

- Aronson, D. and Howard, P., 1997, Anaerobic Biodegradation of Organic Chemicals in Groundwater: A Summary of Field and Laboratory Studies (SRC TR-97-0223F), Environmental Science Center, Syracuse Research Corporation, 6225 Running Ridge Road, North Syracuse, NY 13212-2509.
- Arthur D. Little, Inc., 1985, The Installation Restoration Program Toxicology Guide. Volume 1. Prepared for Air Force Systems Command, Wright-Patterson Air Force Base, OH, October 1985.
- Arthur D. Little, Inc., 1987, The Installation Restoration Program Toxicology Guide. Volume 3. Prepared for Air Force Systems Command, Wright-Patterson Air Force Base, OH, June 1987.
- ASTM, 1995, Emergency Standard Guide for Risk-Based Corrective Action Applied at Petroleum Release Sites: ASTM E-1739, Philadelphia, PA.
- Atlas, R.M., 1984, *Petroleum Microbiology*: Macmillan, New York.
- Atlas, R.M., 1981, Microbial degradation of petroleum hydrocarbons - an Environmental Perspective: *Microbiol. Rev.*, 45(1):180-209.
- Atlas, R.M., 1988, *Microbiology - Fundamentals and Applications*: Macmillan, New York.
- ATSDR, 1990, Toxicological Profile for Hexachlorobenzene: Agency for Toxic Substances and Disease Registry, USPHS/USEPA, December 1990.
- Avon, L., and Bredehoeft, J.D., 1989, An analysis of trichloroethylene movement in groundwater at Castle Air Force Base, California: *J. Hydrol.*, 110:23-50.
- Baedecker, M.J., and Back, W., 1979, Hydrogeological processes and chemical reactions at a landfill: *Ground Water*, 17(5): 429-437.
- Baedecker, M.J., Siegel, D.I., Bennett, P.C., and Cozzarelli, I.M., 1988, The fate and effects of crude oil in a shallow aquifer: I. The distribution of chemical species and geochemical facies, *In U.S. Geological Survey Toxic Substances Hydrology Program, Proceedings of the Technical Meeting, Phoenix, AZ*: (Mallard, G.E. and Ragone, S.E., Eds.), September 26-30, 1988: U.S. Geological Survey Water-Resources Investigations Report 88-42320, p.13-20.
- Baehr, A.L., and Corapcioglu, M.Y., 1987, A compositional multiphase model for groundwater contamination by petroleum products: 2. Numerical simulation: *Water Resour. Res.*, 23:201-203.
- Baek, N.H., and Jaffe, P.R., 1989, The degradation of trichloroethylene in mixed methanogenic cultures: *J. Environ. Qual.*, 18:515-518.
- Bailey, G.W., and White, J.L., 1970, Factors influencing the adsorption, desorption, and movement of pesticides in soil, *In Residue Reviews*: (Gunther, F.A. and Gunther, J.D., Eds.), Springer Verlag, p. 29-92.
- Ballesterro, T.P., Fiedler, F.R., and Kinner, N.E., 1994, An investigation of the relationship between actual and apparent gasoline thickness in a uniform sand aquifer: *Ground Water*, 32(5):708-718.
- Banerjee, P., Piwoni, M.D., and Ebeid, K., 1985, Sorption of organic contaminants to a low carbon subsurface core: *Chemosphere*, 14(8):1057-1067.
- Barbee, G.C., 1994, Fate of chlorinated aliphatic hydrocarbons in the vadose zone and groundwater: *Ground Water Monit. Remed.*, 14(1):129-140.
- Barker, J.F., Patrick, G.C., and Major, D., 1987, Natural attenuation of aromatic hydrocarbons in a shallow sand aquifer: *Ground Water Monit. Rev.*, Winter 1987, p. 64-71.

- Barr, K.D., 1993, Enhanced groundwater remediation by bioventing and its simulation by biomodeling: *In Proceedings of the Environmental Restoration Technology Transfer Symposium*: (R.N. Miller, Ed.), January 26-27, 1993.
- Barrio-Lage, G.A., Parsons, F.Z., Narbaitz, R.M., and Lorenzo, P.A., 1990, Enhanced anaerobic biodegradation of vinyl chloride in ground water: *Environ. Toxicol. Chem.*, 9:403-415.
- Barrio-Lage, G.A., Parsons, F.Z., Nassar, R.S., and Lorenzo, P.A., 1987, Biotransformation of trichloroethene in a variety of subsurface materials: *Environ. Toxicol. Chem.* 6:571-578.
- Bartha, R., 1986, Biotechnology of petroleum pollutant biodegradation: *Microb. Ecol.*, 12:155-172.
- Bear, J., 1972, *Dynamics of Fluids in Porous Media*: Dover Publications, New York, 764 p.
- Bear, J., 1979, *Hydraulics of Groundwater*: McGraw-Hill, New York, 569 p.
- Bedient, P.B., Rifai, H.S., and Newell, C.J., 1994, *Groundwater Contamination - Transport and Remediation*: PTR Prentice Hall, New Jersey, 541 p.
- Beller, H.R., Grbić-Galić, D., and Reinhard, M., 1992b, Microbial degradation of toluene under sulfate-reducing conditions and the influence of iron on the process: *Appl. Environ. Microbiol.*, 58:786-793.
- Beller, H.R., Reinhard, M., and Grbić-Galić, D., 1992, Metabolic byproducts of anaerobic toluene degradation by sulfate-reducing enrichment cultures: *Appl. Environ. Microbiol.*, 58:3192-3195.
- Benker, E., Davis, G.B., Appleyard, S., Berry, D.A., and Power, T.R., 1994, Groundwater contamination by trichloroethene (TCE) in a residential area of Perth: Distribution, mobility, and implications for management, *In Proceedings - Water Down Under '94*, 25th Congress of IAH, Adelaide, South Australia, November 1994.
- Blake, S.B., and Hall, R.A., 1984, Monitoring petroleum spills with wells - some problems and solutions: *In Proceedings of the Fourth National Symposium on Aquifer Restoration and Groundwater Monitoring*: May 23-25, 1984, p. 305-310.
- Borden, R.C. and Bedient, P.B., 1986, Transport of dissolved hydrocarbons influenced by oxygen limited biodegradation - theoretical development: *Water Resour. Res.*, 22(13):1973-1982.
- Borden, R.C., Gomez, C.A., and Becker, M.T., 1994, Natural bioremediation of a gasoline spill. *In Hydrocarbon Bioremediation*: (Hinchee, R.E., Alleman, B.C., Hoepfel, R.E., and Miller, R.N., Eds.) p. 290-295. Lewis Publishers, Chelsea, MI.
- Borden, R.C., Gomez, C.A., and Becker, M.T., 1995, Geochemical indicators of intrinsic bioremediation: *Ground Water*, 33(2):180-189.
- Bosma, T.N.P., van der Meer, J.R., Schraa, G., Tros, M.E., and Zehnder, A.J.B., 1988, reductive dechlorination of all trichloro- and dichlorobenzene isomers: *FEMS Microbiol. Ecol.*, 53:223-229.
- Bouwer, E.J., and McCarty, P.L., 1983, Transformations of 1- and 2-carbon halogenated aliphatic organic compounds under methanogenic conditions. *Appl. Environ. Microbiol.*, 45:1286-1294.
- Bouwer, E.J., and McCarty, P.L., 1984, Modeling of trace organics biotransformation in the subsurface: *Ground Water*, 22(4):433-440.
- Bouwer, E.J., Rittman, B.E., and McCarty, P.L., 1981, Anaerobic degradation of halogenated 1- and 2-carbon organic compounds: *Environ. Sci. Technol.*, 15(5):596-599.

- Bouwer, E.J. and Wright, J.P., 1988, Transformations of trace halogenated aliphatics in anoxic biofilm columns: *J. Contam. Hydrol.*, 2:155-169.
- Bouwer, E.J., 1992, Bioremediation of subsurface contaminants, *In Environmental Microbiology*: (R. Mitchell, Ed.), Wiley-Liss, New York, p. 287-318.
- Bouwer, E.J., 1994, Bioremediation of chlorinated solvents using alternate electron acceptors, *In Handbook of Bioremediation*: (Norris, R.D., Hincee, R.E., Brown, R., McCarty, P.L, Semprini, L., Wilson, J.T., Kampbell, D.H., Reinhard, M., Bouwer, E.J., Borden, R.C., Vogel, T.M., Thomas, J.M., and Ward, C.H., Eds.), Lewis Publishers, Boca Raton, FL, p.149-175.
- Bouwer, H., and Rice, R.C., 1976, A slug test for determining hydraulic conductivity of unconfined aquifers with completely or partially penetrating wells: *Water Resour. Res.*, 12(3):423-428.
- Bouwer, H., 1989, The Bouwer and Rice slug test - an update: *Ground Water*, 27(3): 304-309.
- Bradley, P.M., and Chapelle, F.H., 1996, Anaerobic mineralization of vinyl chloride in Fe(III)-reducing aquifer sediments: *Environ. Sci. Technol.*, 40:2084-2086.
- Bradley, P.M., and Chapelle, F.H., 1997, Kinetics of DCE and VC mineralization under methanogenic and Fe(III)-reducing conditions: *Environ. Sci. Technol.*, 31:2692-2696.
- Bradley, P.M., Chapelle, F.H., and Wilson, J.T., 1998, Field and laboratory evidence for intrinsic biodegradation of vinyl chloride contamination in a Fe(III)-reducing aquifer: *J. Cont. Hydrol.*, in press.
- Bredehoeft, J.D., and Konikow, L.F., 1993, Ground-water models - validate or invalidate: *Ground Water*, 31(2):178-179.
- Briggs, G.G., 1981, Theoretical and experimental relationships between soil adsorption, octanol-water partition coefficients, water solubilities, bioconcentration factors, and the parachor: *J. Agricul. Food Chem.*, 29:1050-1059.
- Broholm, K., and Feenstra, S., 1995, Laboratory measurements of the aqueous solubility of mixtures of chlorinated solvents: *Environ. Toxicol. Chem.*, 14:9-15.
- Brown, D.S. and Flagg, E.W., 1981, Empirical prediction of organic pollutant sorption in natural sediments: *J. Environ. Qual.*, 10(3):382-386.
- Bruce, L., Miller, T., and Hockman, B., 1991, Solubility versus equilibrium saturation of gasoline compounds - a method to estimate fuel/water partition coefficient using solubility or Koc, *In NWWA/API Conference on Petroleum Hydrocarbons in Ground Water*: (A. Stanley, Ed.), NWWA/API, p. 571-582.
- Brunner W., and Leisinger, T., 1978, Bacterial degradation of dichloromethane: *Experientia*, 34:1671.
- Brunner, W., Staub, D., and Leisinger, T., 1980, Bacterial degradation of dichloromethane: *Appl. Environ. Microbiol.*, 40(5):950-958.
- Brusseau, M.L., 1992, Rate-limited mass transfer and transport of organic solutes in porous media that contain immobile immiscible organic liquid: *Water Resour. Res.*, 28:33-45.
- Buscheck, T.E. and Alcantar, C.M., 1995, Regression techniques and analytical solutions to demonstrate intrinsic bioremediation, *In Proceedings of the 1995 Battelle International Conference on In-Situ and On Site Bioreclamation*, April 1995.
- Butler, B.J., and Barker, J.F., 1996, Chemical and microbiological transformation and degradation of chlorinated solvent compounds, *In Dense Chlorinated Solvents and Other DNAPLs in Groundwater: History, Behavior, and Remediation*: (Pankow, J.F., and Cherry, J.A., Eds.), Waterloo Press, Waterloo, Ontario, p. 267-312.

- Cerniglia, C. E., 1984, Microbial transformation of aromatic hydrocarbons, *In Petroleum Microbiology*: (Atlas, R.M., Ed.) Macmillan, New York., p. 99-128.
- Chappelle, F.H., Haack, S.K., Adriaens, P., Henry, M.A., and Bradley, P.M., 1996, Comparison of Eh and H₂ measurements for delineating redox processes in a contaminated aquifer: *Environ. Sci. Technol.*, 30(12):3565-3569.
- Chappelle, F.H., McMahon, P.B., Dubrovsky, N.M., Fujii, R.F., Oaksford, E.T., and Vroblesky, D.A., 1995, Deducing the distribution of terminal electron-accepting processes in hydrologically diverse groundwater systems: *Water Resour. Res.*, 31:359-371.
- Chappelle, F.H., Vroblesky, D.A., Woodward, J.C., and Lovley, D.R., 1997, Practical considerations for measuring hydrogen concentrations in groundwater: *Environ. Sci. Technol.*, 31(10):2873-2877.
- Chappelle, F.H., 1993, *Ground-Water Microbiology and Geochemistry*: John Wiley & Sons, New York, 424 p.
- Chappelle, F.H., 1996, Identifying redox conditions that favor the natural attenuation of chlorinated ethenes in contaminated ground-water systems, *In Proceedings of the Symposium on Natural Attenuation of Chlorinated Organics in Ground Water, Dallas, TX, September 11-13, 1996*: EPA/540/R-96/509.
- Chiang, C.Y., Salanitro, J.P., Chai, E.Y., Colthart, J.D., and Klein, C.L., 1989, Aerobic biodegradation of benzene, toluene, and xylene in a sandy aquifer - data analysis and computer modeling: *Ground Water*, 27(6):823-834.
- Chiou, C.T., Porter, P.E., and Schmedding, D.W., 1983, Partition equilibria of nonionic organic compounds between soil organic matter and water: *Environ. Sci. Technol.*, 17(4):227-231.
- Ciccioli, P., Cooper, W.T., Hammer, P.M., and Hayes, J.M., 1980, Organic solute-mineral surface interactions; a new method for the determination of groundwater velocities: *Water Resour. Res.*, 16(1):217-223.
- Clement, T.P., 1996, Personal communication regarding proposed development of a reactive solute transport model (tentatively called RT3D). Battelle Pacific Northwest Laboratories, April 1996.
- Cline, P.V., and Delfino, J.J., 1989, Transformation kinetics of 1,1,1-trichloroethane to the stable product 1,1-dichloroethene, *In Biohazards of Drinking Water Treatment*: Lewis Publishers, Chelsea, MI, p. 47-56.
- Cline, P.V., Delfino, J.J., and Rao, P.S.C., 1991, Partitioning of aromatic constituents into water from gasoline and other complex solvent mixtures: *Environ. Sci. Technol.*, 25:914-920.
- Cooper, W.J., Mehran, M., Riusech, D.J., and Joens, J.A., 1987, Abiotic transformation of halogenated organics: 1. Elimination reaction of 1,1,2,2-tetrachloroethane and formation of 1,1,2-trichloroethane: *Environ. Sci. Technol.*, 21:1112-1114.
- Cox, E., Edwards, E., Lehmicke, L., and Major, D., 1995, Intrinsic biodegradation of trichloroethylene and trichloroethane in a sequential anaerobic-aerobic aquifer, *In Intrinsic Bioremediation*: (Hinchee, R.E., Wilson, J.T., and Downey, D.C., Eds.), Battelle Press, Columbus, OH, p. 223-231.
- Cozzarelli, I.M., Baedecker, M.J., Eganhouse, R.P., and Goerlitz, D.F., 1994, The geochemical evolution of low-molecular-weight organic acids derived from the degradation of petroleum contaminants in groundwater: *Geochimica et Cosmochimica Acta*, 58(2):863-877.

- Cozzarelli, I.M., Eganhouse, R.P., and Baedecker, M.J., 1990, Transformation of monoaromatic hydrocarbons to organic acids in anoxic groundwater environment: *Environ. Geol. Water Sci.*, 16(2):135-142.
- Cozzarelli, I.M., Herman, J.S., and Baedecker, M.J., 1995, Fate of microbial metabolites of hydrocarbons in a coastal plain aquifer: the role of electron acceptors: *Environ. Sci. Technol.*, 29(2):458-469.
- CRC, 1996, *CRC Handbook of Chemistry and Physics*: CRC Press.
- CRC, 1956, *Handbook of Chemistry and Physics*: CRC Press.
- Criddle, C.S., McCarty, P.L., Elliot, M.C., and Barker, J.F., 1986, Reduction of hexachloroethane to tetrachloroethylene in groundwater: *J. Contam. Hydrol.*, 1:133-142.
- Cripps, R.E., and Watkinson, R.J., 1978, Polycyclic aromatic hydrocarbon metabolism and environmental aspects, *In Developments in Biodegradation of Hydrocarbons - 1*: (Watkinson, J. R., Ed.), Applied Science Publishers, Ltd., London, p. 133-134.
- Curtis, C.D., 1985, Clay mineral precipitation and transformation during burial diagenesis: *Philosophical Transactions of the Royal Society, London*, v. 315, p. 91-105.
- Dalton, H., and Stirling, D.E., Co-metabolism: *Philosophical Transactions of the Royal Society, London*, v. 297, p. 481-496.
- Davies, J.S. and Westlake, D.W.S., 1979, Crude oil utilization by fungi: *Can. J. Microbiol.*, 25:146-156.
- Davis, J.W., Klier, N.J., and Carpenter, C.L., 1994a, Natural biological attenuation of benzene in groundwater beneath a manufacturing facility: *Ground Water*, 32(2):215-226.
- Davis, J.W., and Carpenter, C.L., 1990, Aerobic biodegradation of vinyl chloride in groundwater samples: *Appl. Environ. Microbiol.*, 56:3878.
- Davis, R.K., Pederson, D.T., Blum, D.A., and Carr, J.D., 1993, Atrazine in a stream-aquifer system - estimation of aquifer properties from atrazine concentration profiles: *Ground Water Monit. Rev.*, Spring, 1993, p.134-141
- Davis, A., Campbell, J., Gilbert, C., Ruby, M.V., Bennett, M., and Tobin, S., 1994b, Attenuation and biodegradation of chlorophenols in groundwater at a former wood treating facility: *Ground Water*, 32(2):248-257.
- Dawson K.J. and Istok, J.D., 1991, *Aquifer Testing - Design and analysis of pumping and slug tests*: Lewis Publishers, Chelsea, MI, 344 p.
- de Bont, J.A.M., Vorage, M.J.W., Hartmans, S., and van den Tweel, W.J.J., 1986, Microbial degradation of 1,3-dichlorobenzene: *Appl. and Environ. Microbiol.*, 52:677-680.
- de Pastrovich, T.L., Baradat, Y., Barthel, R., Chiarelli, A., and Fussell, D.R., 1979, *Protection of Groundwater from Oil Pollution*: CONCAWE, The Hague, 61 p.
- De Bruin, W.P., Kotterman, M.J.J., Posthumus, M.A., Schraa, G., and Zehnder, A.J.B., 1992, Complete biological reductive transformation of tetrachloroethene to ethane: *Appl. Environ. Microbiol.*, 58(6):1966-2000.
- Dean, J.A., 1972, *Lange's Handbook of Chemistry*, 13th ed.: McGraw-Hill, New York.
- DeStefano, T.D., Gossett, J.M., and Zinder, S.H., 1991, Reductive dehalogenation of high concentrations of tetrachloroethene to ethene by an anaerobic enrichment culture in the absence of methanogenesis: *Appl. Environ. Microbiol.*, 57(8):2287-2292.
- Deviny, J.S., Everett, L.G., Lu, J.C.S., and Stollar, R.L., 1990, *Subsurface Migration of Hazardous Wastes*: Van Nostrand Reinhold, 387 p.

- Dilling, W.L., Tfertiller, N.B., and Kallos, G.J., 1975, Evaporation rates and reactivities of methylene chloride, chloroform, 1,1,1-trichloroethane, trichloroethylene, tetrachloroethylene, and other chlorinated compounds in dilute aqueous solutions: *Environ. Sci. Technol.*, 9:833-838.
- Dolfing, J., and Harrison, B.K., 1992, The Gibbs free energy of formation of halogenated aromatic compounds and their potential role as electron acceptors in anaerobic environments: *Environ. Sci. Technol.*, 26:2213-2218.
- Domenico, P.A., and Schwartz, F.W., 1990, *Physical and Chemical Hydrogeology*: John Wiley and Sons, New York, 824 p.
- Domenico, P.A., 1987, An analytical model for multidimensional transport of a decaying contaminant species: *J. Hydrol.*, 91:49-58.
- Donaghue, N.A., Griffin, M., Norris, D.G., and Trudgill, P.W., 1976, The microbial metabolism of cyclohexane and related compounds, *In Proceedings of the Third International Biodegradation Symposium*: (Sharpley, J.M. and Kaplan, A.M., Eds.), Applied Science Publishers, Ltd., London, p. 43-56.
- Downey, D.C. and Gier, M.J., 1991, Supporting the no action alternative at a hydrocarbon spill site: *In Proceedings USAF Environmental Restoration Technology Symposium: 7-8 May, San Antonio, Texas, Section U*, p.1-11.
- Dragun, J., 1988, *The Soil Chemistry of Hazardous Materials*: Hazardous Materials Control Research Institute, Silver Spring, MD, 458 p.
- Driscoll, F.G., 1986, *Groundwater and Wells, Second Edition*: Johnson Division, St. Paul, MN, 1089 p.
- Dunlap, W.J., McNabb, J.F., Scalf, M.R., and Cosby, R.L., 1977, *Sampling for Organic Chemicals and Microorganisms in the Subsurface*, EPA-600/2-77/176, U.S. Environmental Protection Agency, Ada, OK.
- Dupont, R.R., Gorder, K., Sorenson, D.L., Kemblowski, M.W., and Haas, P., 1996, Case study: Eielson Air Force Base, Alaska, *In Proceedings of the Symposium on Natural Attenuation of Chlorinated Organics in Ground Water, Dallas, TX, September 11-13 1996*: EPA/540/R-96/509.
- Edwards, E.A., and Grbić-Galić, D., 1992, Complete mineralization of benzene by aquifer microorganisms under strictly anaerobic conditions: *Appl. Environ. Microbiol.*, 58:2663-2666.
- Edwards, E.A., and Grbić-Galić, D., 1994, Anaerobic degradation of toluene and *o*-xylene by a methanogenic consortium: *Appl. Environ. Microbiol.*, 60:313-322.
- Edwards, E.A., Wells, L.E., Reinhard, M., and Grbić-Galić, D., 1992, Anaerobic degradation of toluene and xylene by aquifer microorganisms under sulfate-reducing conditions: *Appl. Environ. Microbiol.*, 58:794-800.
- Egli, C., Scholtz, R., Cook, A.M., and Leisinger, T., 1987, Anaerobic dechlorination of tetrachloromethane and 1,2-dichloroethane to degradable products by pure cultures of *Desulfobacterium* sp. and *Methanobacterium* sp.: *FEMS Microbiol. Lett.*, 43:257-261.
- Ehlke, T.A., Wilson, B.H., Wilson, J.T., and Imbrigiotta, T.E., 1994, In-situ biotransformation of trichloroethylene and cis-1,2-dichloroethylene at Picatinny Arsenal, New Jersey, *In Proceedings of the U.S. Geological Survey Toxic Substances Program, Colorado Springs, CO*: (Morganwalp, D.W. and Aranson, D.A., Eds.), Water Resources Investigation Report 94-4014.

- Ellis, D.E., Lutz, E.J., Klecka, G.M., Pardieck, D.L., Salvo, J.J., Heitkamp, M.A., Gannon, D.J., Mikula, C.C., Vogel, C.M., Sayles, G.D., Kampbell, D.H., Wilson, J.T., and Maiers, D.T., 1996, Remediation Technology Development Forum Intrinsic Remediation Project at Dover Air Force Base, Delaware, *In Proceedings of the Symposium on Natural Attenuation of Chlorinated Organics in Ground Water, Dallas, TX, September 11-13, 1996*: EPA/540/R-96/509.
- Evans, P.J., Mang, D.T., and Young, L.Y., 1991a, Degradation of toluene and *m*-xylene and transformation of *o*-xylene by denitrifying enrichment cultures: *Appl. Environ. Microbiol.*, 57:450-454.
- Evans, P.J., Mang, D.T., Kim, K.S., and Young, L.Y., 1991b, Anaerobic degradation of toluene by a denitrifying bacterium: *Appl. Environ. Microbiol.*, 57: 1139-1145.
- Ewers, J.W., Clemens, W., and Knackmuss, H.J., 1991, Biodegradation of chloroethenes using isoprene as a substrate, *In Proceedings of International Symposium: Environmental Biotechnology*: European Federation of Biotechnology, Oostende, Belgium, April 1991, p. 77-83.
- Farr, A.M., Houghtalen, R.J., and McWhorter, D.B., 1990, Volume estimation of light non-aqueous phase liquids in porous media: *Ground Water*, 28(1):48-56.
- Fathepure, B.Z., and Boyd, S.A., 1988, Dependence of tetrachloroethylene dechlorination on methanogenic substrate consumption by *Methanosarcina* sp. strain DCM: *Appl. Environ. Microbiol.*, 54(12):2976-2980.
- Fathepure, B.Z., Nengu, J.P., and Boyd, S.A., 1987, Anaerobic bacteria that dechlorinate perchloroethene: *Appl. Environ. Microbiol.*, 53:2671-2674.
- Fathepure, B.Z., Tiedje, J.M., and Boyd, S.A., 1988, Reductive dechlorination of hexachlorobenzene to tri- and dichlorobenzenes in an anaerobic sewage sludge: *Appl. Environ. Microbiol.*, 54:327-330.
- Fathepure, B.Z., and Vogel, T.M., 1991, Complete biodegradation of polychlorinated hydrocarbons by a two-stage biofilm reactor: *Appl. Environ. Microbiol.*, 57:3418-3422.
- Faust, C.R., Sims, P.N., Spalding, C.P., Andersen, P.F., and Stephenson, D.E., 1990, FTWORK: A three-dimensional groundwater flow and solute transport code: Westinghouse Savannah River Company Report WSRC-RP-89-1085, Aiken, SC.
- Feenstra, S., and Guiguer, N., 1996, Dissolution of dense non-aqueous phase liquids in the subsurface, *In Dense Chlorinated Solvents and Other DNAPLs in Groundwater*: (Pankow, J.F., and Cherry, J.A., Eds.) Waterloo Press, Portland, OR, 522 p.
- Fetter C.W., 1988, *Applied Hydrogeology*: Merrill Publishing, Columbus, OH, 592 p.
- Fetter, C.W., 1993, *Contaminant Hydrogeology*: Macmillan, New York, 458 p.
- Fogel, M.M., Taddeo, A.R., and Fogel, S., 1986, Biodegradation of chlorinated ethenes by a methane-utilizing mixed culture: *Appl. Environ. Microbiol.*, 51(4):720-724.
- Folsom, B.R., Chapman, P.J., and Pritchard, P.H., 1990, Phenol and trichloroethylene degradation by *Pseudomonas cepacia* G4: Kinetics and interactions between substrates: *Appl. Environ. Microbiol.*, 56(5):1279-1285.
- Franke, O.L., Reilly T.E., and Bennett, G.D., 1987, Definition of boundary and initial conditions in the analysis of saturated ground-water flow systems - an introduction: United States Geological Survey Techniques of Water-Resources Investigations Book 3, Chapter B5, 15 p.

- Freedman, D.L., and Gossett, J.M., 1989, Biological reductive dehalogenation of tetrachloroethylene and trichloroethylene to ethylene under methanogenic conditions: *Appl. Environ. Microbiol.*, 55(4):1009-1014.
- Freeze, R.A., and Cherry, J.A., 1979, *Groundwater*: Prentice-Hall, Englewood Cliffs, NJ, 604 p.
- Freeze, R.A., and McWhorter, D.B., 1997, A framework for assessing risk-reduction due to DNAPL mass removal from low-permeability soils: *Ground Water*, 35(1):111-123.
- Gantzer, C.J., and Wackett, L.P., 1991, Reductive dechlorination catalyzed by bacterial transition-metal coenzymes: *Environ. Sci. Technol.*, 25:715-722.
- Gelhar, L.W., Welty, L., and Rehfeldt, K.R., 1992, A critical review of data on field-scale dispersion in aquifers: *Water Resour. Res.*, 28(7):1955-1974.
- Gelhar, L.W., Montoglou, A., Welty, C., and Rehfeldt, K.R., 1985, A review of field scale physical solute transport processes in saturated and unsaturated porous media, Final Project Report, EPRI EA-4190: Electric Power Research Institute, Palo Alto, CA.
- Gerritse, J., Renard, V., Pedro-Gomes, T.M., Lawson, P.A., Collins, M.D., and Gottschal, J.C., 1996, *Desulfitobacterium* sp. strain PCE1, an anaerobic bacterium that can grow by reductive dechlorination of tetrachloroethene or *ortho*-chlorinated phenols: *Arch. Microbiol.*, 165:132-140.
- Gibbs, C. R., 1976, Characterization and application of ferrozine iron reagent as a ferrous iron indicator: *Anal. Chem.*, 48:1197-1200
- Gibson, S.A., and Sewel, G.W., 1990, Stimulation of the Reductive Dechlorination of Tetrachloroethene in Aquifer Slurries by Addition of Short-Chain Fatty Acids. Abstracts of the Annual Meeting of the American Society for Microbiology, Anaheim, CA, 14-18 May, 1990.
- Gibson, D.T., and Subramanian, V., 1984, Microbial degradation of aromatic hydrocarbons, *In Microbial Degradation of Organic Compounds*: (D.T. Gibson, Ed.), Marcel-Dekker, New York, p. 181-252.
- Gibson, D.J., 1971, The microbial oxidation of aromatic hydrocarbons: *Crit. Rev. Microbiol.*, 1:199-223.
- Gillham, R.W., and O'Hannesin, S.F., 1994, Enhanced degradation of halogenated aliphatics by zero-valent iron: *Ground Water*, 32(6):958-967.
- Glantz, S.A., 1992, *Primer of Biostatistics*: McGraw-Hill, New York.
- Godsy, E.M., Goerlitz, D.F., and Grbić-Galić, D., 1992a, Methanogenic biodegradation of creosote contaminants in natural and simulated ground-water ecosystems: *Ground Water*, 30(2):232-242.
- Godsy, E.M., Goerlitz, D.F., and Grbić-Galić, D., 1992b, Methanogenic degradation kinetics of phenolic compounds in aquifer-derived microcosms: *Biodegradation*, 2:211-221.
- Goldstein, R.M., Mallory, L.M., and Alexander, M., 1985, Reasons for possible failure of inoculation to enhance biodegradation: *Appl. Environ. Microbiol.*, 50(4):977-983.
- Gorder, K.A., Dupont, R.R., Sorenson, D.L., Kembrowski, M.W., and McLean, J.E., 1996, Analysis of intrinsic bioremediation of trichloroethene-contaminated ground water at Eielson Air Force Base, Alaska, *In Proceedings of the Symposium on Natural Attenuation of Chlorinated Organics in Ground Water*, Dallas, TX: EPA/540/R-96/509, September

- 1996.
- Gossett, J.M., and Zinder, S.H., 1996, Microbiological aspects relevant to natural attenuation of chlorinated ethenes, *In Proceedings of the Symposium on Natural Attenuation of Chlorinated Organics in Ground Water, Dallas, TX: EPA /540/R-96/509*, September 1996.
- Grbić-Galić, D., and Vogel, T.M., 1987, Transformation of toluene and benzene by mixed methanogenic cultures: *Appl. Environ. Microbiol.*, 53:254-260.
- Grbić-Galić, D., 1990, Anaerobic microbial transformation of nonoxygenated aromatic and alicyclic compounds in soil, subsurface, and freshwater sediments: *In Soil Biochemistry: (Bollag, J.M., and Stotzky, G., Eds.)*, Marcel Dekker, New York, p. 117-189.
- Guiguer, N., and Frind, E.O., 1994, Dissolution and mass transfer processes for residual organics in the saturated groundwater zone, *In Proceedings of the International Symposium on Transport and Reactive Processes in Aquifers: International Association for Hydraulic Research, Zurich, April 11-15, 1994*.
- Guiguer, N., 1993, Dissolution and mass transfer processes for residual organics in the saturated groundwater zone: Numerical modeling: Ph.D. Thesis, Dept. of Earth Sciences, University of Waterloo, Waterloo, Ontario.
- Haigler, B.E., Nishino, S.F., and Spain, J.C., 1988, Degradation of 1,2-dichlorobenzene by a *Pseudomonas sp.*: *Appl. Environ. Microbiol.*, 54:294-301.
- Hall, R.A., Blake, S.B., and Champlin, S.C. Jr., 1984, Determination of hydrocarbon thicknesses in sediments using borehole data: *In Proceedings of the Fourth National Symposium on Aquifer Restoration and Groundwater Monitoring: May 23-25, 1984*. p. 300-304.
- Harker, A.R., and Kim, Y., 1990, Trichloroethylene degradation by two independent aromatic-degrading pathways in *Alcaligenes eutrophus* JMP134: *Appl. Environ. Microbiol.*, 56(4):1179-1181.
- Harlan R.L., Kolm, K.E., and Gutentag, E.D., 1989, Water-Well Design and Construction, *Developments in Geotechnical Engineering, Number 60: Elsevier*, 205 p.
- Hartmans, S., de Bont, J.A.M., Tramper, J., and Luyben, K.Ch.A.M., 1985, Bacterial degradation of vinyl chloride: *Biotechnol. Lett.*, 7(6):383-388.
- Hartmans, S., and de Bont, J.A.M., 1992, Aerobic vinyl chloride metabolism in *Mycobacterium aurum* Li: *Appl. Environ. Microbiol.*, 58(4):1220-1226.
- Hassett, J.J., Banwart, W.L., and Griffin, R.A., 1983, Correlation of compound properties with sorption characteristics of nonpolar compounds by soils and sediments; concepts and limitations, *In Environment and Solid Wastes: (Francis, C.W., and Auerbach, S.I., Eds.)*, Butterworths, Boston, p. 161-178.
- Hassett, J.J., Means, J.C., Banwart, W.L., and Wood, S.G., 1980, Sorption Properties of Sediments and Energy-Related Pollutants: EPA/600/3-80/041, U.S. Environmental Protection Agency, Washington, D.C.
- Haston, Z.C., Sharma, P.K., Black, J.N.P., and McCarty, P.L., 1994, Enhanced reductive dechlorination of chlorinated ethenes, *In Proceedings of the EPA Symposium on Bioremediation of Hazardous Wastes: Research, Development, and Field Evaluations: EPA/600/R-94/075*.
- Hem, J.D., 1985, Study and Interpretation of the Chemical Characteristics of Natural Water: United States Geological Survey Water Supply Paper 2254, 264 p.
- Henry, S.M., 1991, Transformation of Trichloroethylene by Methanotrophs from a Groundwater Aquifer. Ph.D. Thesis. Stanford University, Palo Alto, CA.

- Henry, S.M., and Grbić-Galić, D., 1990, Effect of mineral media on trichloroethylene oxidation by aquifer methanotrophs: *Microb. Ecol.*, 20:151-169.
- Henry, S.M., and Grbić-Galić, D., 1991a, Influence of endogenous and exogenous electron donors and trichloroethylene oxidation toxicity on trichloroethylene oxidation by methanotrophic cultures from a groundwater aquifer: *Appl. Environ. Microbiol.*, 57(1):236-244.
- Henry, S.M., and Grbić-Galić, D., 1991b, Inhibition of trichloroethylene oxidation by the transformation intermediate carbon monoxide: *Appl. Environ. Microbiol.*, 57(6):1770-1776.
- Henson, J.M., Yates, M.V., and Cochran, J.W., 1989, Metabolism of chlorinated methanes, ethanes, and ethylenes by a mixed bacterial culture growing off methane: *J. Ind. Microbiol.*, 4:29-35.
- Heron, G., Crouzet, C., Bourg, A.C.M., and Christensen, T.H., 1994, Speciation of Fe (II) and Fe(III) in contaminated aquifer sediment using chemical extraction techniques: *Environ. Sci. and Technol.*, 28:1698-1705
- Higgins, I.J., and Gilbert, P.D., 1978, The biodegradation of hydrocarbons, *In The Oil Industry and Microbial Ecosystems*: (Chator, K.W.A., and Somerville, H.J., Eds.), Heyden and Sons, London, p. 80-114.
- Hinchee, R.E., Ong, S.K., Miller, R.N., Downey, D.C., and Frandt, R., 1992, Test Plan and Technical Protocol for a Field Treatability Test for Bioventing, Rev. 2: U.S. Air Force Center for Environmental Excellence, Brooks Air Force Base, TX.
- Holliger, C., Schraa, G., Stams, A.J.M., and Zehnder, A.J.B., 1992, Enrichment and properties of an anaerobic mixed culture reductively dechlorinating 1,2,3-trichlorobenzene to 1,3-dichlorobenzene: *Appl. Environ. Microbiol.*, 58:1636-1644.
- Holliger, C., Schraa, G., Stams, A.J.M., and Zehnder, A.J.B., 1993, A highly purified enrichment culture couples the reductive dechlorination of tetrachloroethene to growth: *Appl. Environ. Microbiol.*, 59:2991-2997.
- Holliger, C., and Schumacher, W., 1994, Reductive dehalogenation as a respiratory process: *Antonie van Leeuwenhoek*, 66:239-246.
- Hopper, D.J., 1978, Incorporation of [¹⁸O] water in the formation of p-hydroxybenzyl alcohol by the p-cresol methylhydroxylase from *Pseudomonas putida*: *Biochem. J.*, 175:345-347.
- Howard, P.H., Boethling, R.S., Jarvis, W.F., Meylan, W.M., and Michalenko, E.M., 1991, *Handbook of Environmental Degradation Rates*: Lewis Publishers, Chelsea, MI.
- Howard, P.H., 1989, *Handbook of Environmental Fate and Exposure Data for Organic Chemicals, Volume I: Large Production and Priority Pollutants*: Lewis Publishers, Chelsea, MI, 574 p.
- Howard, P.H., 1990, *Handbook of Environmental Fate and Exposure Data for Organic Chemicals, Vol. II: Solvents*: Lewis Publishers, Chelsea, MI, 546 p.
- Hubbert, M.K., 1940, The theory of groundwater motion: *J. Geol.*, 48:785-944.
- Hughes, J.P., Sullivan, C.R., and Zinner, R.E., 1988, Two techniques for determining the true hydrocarbon thickness in an unconfined sandy aquifer: *In Proceedings of the Petroleum Hydrocarbons and Organic Chemicals in Ground Water: Prevention, Detection, and Restoration Conference*: NWWA/API, p. 291 -314.
- Hunt, J.R., Sitar, N., and Udell, K.S., 1988, Nonaqueous phase liquid transport and cleanup, 1. Analysis of mechanisms: *Water Resour. Res.*, 24(8):1247-1258.

- Hunt, M.J., Beckman, M.A., Borlaz, M.A., and Borden, R.C., 1995, Anaerobic BTEX Biodegradation in Laboratory Microcosms and In-Situ Columns: Proceedings of the Third International Symposium on In Situ and On-Site Bioreclamation, April 24-27, 1995, San Diego, CA.
- Huntley, D., Hawk, R.N., and Corley, H.P., 1994a, Nonaqueous phase hydrocarbon in a fine-grained sandstone - 1. Comparison between measured and predicted saturations and mobility: *Ground Water*, 32(4):626-634.
- Huntley, D., Wallace, J.W., and Hawk, R.N., 1994b, Nonaqueous phase hydrocarbon in a fine-grained sandstone - 2. Effect of local sediment variability on the estimation of hydrocarbon volumes: *Ground Water*, 32(5):778-783.
- Hutchins, S.R., Sewell, G.W., Kovacs, D.A., and Smith, G.A., 1991, Biodegradation of aromatic hydrocarbons by aquifer microorganisms under denitrifying conditions: *Environ. Sci. Technol.*, 25:68-76.
- Hutchins, S.R., 1991, Biodegradation of monoaromatic hydrocarbons by aquifer microorganisms using oxygen, nitrate, or nitrous oxide as the terminal electron acceptor: *Appl. Environ. Microbiol.*, 57:2403-2407.
- Hvorslev, M.J., 1951, Time lag and soil permeability in ground-water observations: United States Corps of Engineers Waterways Experiment Station Bulletin 36, Vicksburg, MS, 50 p.
- Jafvert, C.T., and Wolfe, N.L., 1987, Degradation of selected halogenated ethanes in anoxic sediment-water systems: *Environ. Toxicol. Chem.*, 6:827-837.
- Jamison, V.W., Raymond, R.L., and Hudson, J.O. Jr., 1975, Biodegradation of high-octane gasoline in groundwater: *Dev. Ind. Microbiol.*, v.16.
- Janssen, D.B., Scheper, A., Dijkhuizen, L., and Witholt, B., 1985, Degradation of halogenated aliphatic compounds by *Xanthobacter autotrophicus* GJ10: *Appl. Environ. Microbiol.*, 49(3):673-677.
- Javandel, I., Doughty, C., and Tsang, C., 1984, Groundwater transport: Handbook of mathematical models: American Geophysical Union Water Resources Monograph Series 10, Washington, D.C., 288 p.
- Jeffers, P.M., Ward, L.M., Woytowitch, L.M., and Wolfe, N.L., 1989, Homogeneous hydrolysis rate constants for selected chlorinated methanes, ethanes, ethenes, and propanes: *Environ. Sci. Technol.*, 23:965-969.
- Jeng, C.Y., Chen, D.H., and Yaws, C.L., 1992, Data compilation for soil sorption coefficient: *Pollut. Eng.*, 24(12):54-60.
- Johnson, R.L., Palmer, C.D., and Fish, W., 1989, Subsurface chemical processes, *In Fate and Transport of Contaminants in the Subsurface*: EPA/625/4-89/019: Environmental Protection Agency, Cincinnati, OH and Ada, OK, p. 41-56.
- Johnson, R.L., and Pankow, J.F., 1992, Dissolution of dense chlorinated solvents in groundwater, 2. Source functions for pools of solvents: *Environ. Sci. Technol.*, 26(5):896-901.
- Jones, J.G. and Eddington, M.A., 1968, An ecological survey of hydrocarbon-oxidizing microorganisms: *J. Gen. Microbiol.*, 52:381-390.
- Jury, W.A., Gardner, W.R., and Gardner, W.H., 1991, *Soil Physics*: John Wiley & Sons, New York, 328 p.
- Kaluarachchi, J.J., and Parker, J.C., 1990, Modeling multicomponent organic chemical transport in three-fluid phase porous media: *J. Contam. Hydrol.*, 5:349-374.

- Kampbell, D.H., and Vandegrift, S.A., 1998, Analysis of dissolved methane, ethane, and ethylene in ground water by a standard gas chromatographic technique: *J. Chromatogr. Sci.*, in press.
- Kampbell, D.H., Wilson, J.T., and Vandegrift, S.A., 1989, Dissolved oxygen and methane in water by a GC headspace equilibrium technique: *Int. J. Environ. Anal. Chem.*, 36:249-257.
- Karickhoff, S.W., Brown, D.S., and Scott, T.A., 1979, Sorption of hydrophobic pollutants on natural sediments: *Water Resour. Res.*, 13:241-248.
- Karickhoff, S.W., 1981, Semi-empirical estimation of sorption of hydrophobic pollutants on natural sediments and soils: *Chemosphere*, 10:833-846.
- Kaufman, W.J., and Orlob, G.T., 1956, Measuring ground water movement with radioactive and chemical tracers: *Am. Water Works Assoc. J.*, 48:559-572.
- Kemblowski, M.W., and Chiang, C.Y., 1990, Hydrocarbon thickness fluctuations in monitoring wells: *Ground Water*, 28(2):244-252.
- Kenaga, E.E., and Goring, C.A.I., 1980, ASTM Special Technical Publication 707: American Society for Testing Materials, Washington, D.C.
- Kennedy, L.G., and Hutchins, S.R., 1992, Applied geologic, microbiologic, and engineering constraints of in-situ BTEX bioremediation: *Remediation*, p. 83-107.
- Klecka, G.M., Gonsior, S.J., and Markham, D.A., 1990, Biological transformations of 1,1,1-trichloroethane in subsurface soils and ground water: *Environ. Toxicol. Chem.*, 9:1437-1451.
- Klecka, G.M., Wilson, J.T., Lutz, E., Klier, N., West, R., Davis, J., Weaver, J., Kampbell, D. and Wilson, B., 1996, Natural attenuation of chlorinated solvents in ground water, *In Proceedings of the IBC/CELTIC Conference on Intrinsic Bioremediation*, London, UK: March 18-19, 1996.
- Klein, C., and Hurlbut Jr., S. C., 1985, *Manual of Mineralogy*: John Wiley & Sons, New York, 596 p.
- Kleopfer, R.D., Easley, D.M., Hass Jr., B.B., and Deihl, T.G., 1985, Anaerobic degradation of trichloroethylene in soil: *Environ. Sci. Technol.*, 19:277-280
- Klier, N.J., West, R.J., and Donberg, P.A, 1998, Aerobic biodegradation of dichloroethylenes in surface and subsurface soils: *Chemosphere*, in press.
- Knox, R.C., Sabatini, D.A., and Canter, L.W., 1993, *Subsurface Transport and Fate Processes*: Lewis Publishers, Boca Raton, FL, 430 p.
- Konikow, L.F., and Bredehoeft, J.D., 1978, Computer model of two-dimensional solute transport and dispersion in groundwater: United States Geological Survey, Techniques of Water Resources Investigations of the United States Geological Survey, Book 7, Chapter C2, 90 p.
- Konikow, L.F., 1978, Calibration of ground-water models, *In Verification of Mathematical and Physical Models in Hydraulic Engineering: American Society of Civil Engineers*: New York, p. 87-93.
- Krumholz, L.R., 1995, A new anaerobe that grows with tetrachloroethylene as an electron acceptor: Abstract presented at the 95th General Meeting of the American Society for Microbiology.
- Kruseman, G.P. and de Ridder, N.A., 1991, Analysis and Evaluation of Pumping Test Data: International Institute for Land Reclamation and Improvement, The Netherlands, 377 p.

- Kuhn, E.P., Colberg, P.J., Schnoor, J.L., Wanner, O., Zehnder, A.J.B., and Schwarzenbach, R.P., 1985, Microbial transformations of substituted benzenes during infiltration of river water to groundwater: laboratory column studies: *Environ. Sci. Technol.*, 19:961-968.
- Kuhn, E.P., Zeyer, J., Eicher, P., and Schwarzenbach, R.P., 1988, Anaerobic degradation of alkylated benzenes in denitrifying laboratory aquifer columns: *Appl. Environ. Microbiol.*, 54:490-496.
- Kukor, J.J., and Olsen, R.H., 1989, Diversity of toluene degradation following long-term exposure to BTEX in situ: *Biotechnology and Biodegradation*: Portfolio Publishing, The Woodlands, TX, p. 405-421.
- Lallemand-Barres, P., and Peaudecerf, P., 1978, Recherche des relations entre la valeur de la dispersivite macroscopique d'un milieu aquifere, ses autres caracteristiques et les conditions de mesure, etude bibliographique Bulletin, Bureau de Recherches Geologiques et Minieres. Sec. 3/4:277-287.
- Langmuir, D. and Whittemore, D.O., 1971, Variations in the stability of precipitated ferric oxyhydroxides, *In Nonequilibrium Systems in Natural Water Chemistry*, Advances in Chemistry Series 106: (J. D. Hem, Ed.), Am. Chem. Soc., Washington, D.C.
- Lanzarone, N.A., and McCarty, P.L., 1990, Column studies on methanotrophic degradation of trichloroethene and 1,2-dichloroethane: *Ground Water*, 28(6):910-919.
- Larson, R.A., and Weber, E.J., 1994, *Reaction Mechanisms in Environmental Organic Chemistry*: Lewis Publishers, Boca Raton, FL, 433 p.
- Leahy, J.G., and Colewell, R.R., 1990, Microbial degradation of hydrocarbons in the environment: *Microbiol. Rev.*, 53(3):305-315.
- Lee, M.D., Mazierski, P.F., Buchanan, R.J. Jr., Ellis, D.E., and Sehayek, L.S., 1995, Intrinsic and in situ anaerobic biodegradation of chlorinated solvents at an industrial landfill, *In Intrinsic Bioremediation*: (Hinchee, R.E., Wilson, J.T., and Downey, D.C., Eds.), Battelle Press, Columbus, OH, p. 205-222.
- Lee, M.D., 1988, Biorestitution of aquifers contaminated with organic compounds: *CRC Crit. Rev. Environ. Control*, 18:29-89.
- Lenhard, R.J., and Parker, J.C., 1990, Estimation of free hydrocarbon volume from fluid levels in monitoring wells: *Ground Water*, 28(1):57-67.
- Little, C.D., Palumbo, A.V., Herbes, S.E., Lidstrom, M.E., Tyndall, R.L., and Gilmer, P.J., 1988, Trichloroethylene biodegradation by a methane-oxidizing bacterium: *Appl. Environ. Microbiol.*, 54(4):951-956.
- Lovley, D.R., 1987, Organic matter mineralization with the reduction of ferric iron: A review. *Geomicrobiology J.*, 5:375-399.
- Lovley, D.R., 1991, Dissimilatory Fe(III) and Mn(IV) reduction: *Microbiol. Rev.*, June 1991, p. 259-287.
- Lovley, D.R., Baedeker, M.J., Lonergan, D.J., Cozzarelli, I.M., Phillips, E.J.P., and Siegel, D.I., 1989, Oxidation of aromatic contaminants coupled to microbial iron reduction: *Nature*, 339:297-299.
- Lovley, D.R., Chapelle, F.H., and Woodward, J.C., 1994, Use of dissolved H² concentrations to determine distribution of microbially catalyzed redox reactions in anoxic groundwater. *Environ. Sci. Technol.*, 28(7):1205-1210.
- Lovley, D.R., Coates, J.D., Woodward, J.C., and Phillips, E.J.P., 1995, Benzene oxidation coupled to sulfate reduction: *Appl. Environ. Microbiol.*, 61(3):953-958.

- Lovley, D.R., and Goodwin, S., 1988, Hydrogen concentrations as an indicator of the predominant terminal electron-accepting reaction in aquatic sediments: *Geochimica et Cosmochimica Acta*, v. 52, p. 2993-3003.
- Lovley, D.R., and Phillips, E.J.P., 1986, Availability of ferric iron for microbial reduction in bottom sediments of the freshwater tidal Potomac River: *Appl. Environ. Microbiol.*, 52:751-757.
- Lovley, D.R., and Phillips, E.J.P., 1987, Competitive mechanisms for inhibition of sulfate reduction and methane production in the zone of ferric iron reduction in sediments: *Appl. Environ. Microbiol.*, 53: 2636-2641.
- Lyman, W.J., Reidy, P.J., and Levy, B., 1992, *Mobility and Degradation of Organic Contaminants in Subsurface Environments*: C.K. Smoley, Chelsea, MI, 395 p.
- Lyman, W.J., 1982, Adsorption coefficient for soils and sediment, *In Handbook of Chemical Property Estimation Methods*: (W.J. Lyman *et al.*, Eds.), McGraw-Hill, New York, 4.1-4.33.
- Lyon, W.G., West, C.C., Osborn, M.L., and Sewell, G.W., 1995, Microbial utilization of vadose zone organic carbon for reductive dechlorination: *J. Environ. Sci. Health*, A30(7):1627-1639.
- Mabey, W., and Mill, T., 1978, Critical review of hydrolysis of organic compounds in water under environmental conditions: *J. Phys. Chem. Ref. Data*, 7:383-415.
- MacIntyre, W.G., Boggs, M., Antworth, C.P., and Stauffer, T.B., 1993, Degradation kinetics of aromatic organic solutes introduced into a heterogeneous aquifer: *Water Resour. Res.*, 29(12):4045-4051.
- Mackay, D.M., Shiu, W.Y., Maijanen, A., and Feenstra, S., 1991, Dissolution of non-aqueous phase liquids in groundwater: *J. Contam. Hydrol.*, 8:23-42.
- Mackenzie, F.T., Garrels, R.M., Bricker, O.P., and Bickley, F., 1967, Silica in sea-water: control by silica minerals: *Science*, 155:1404-1405.
- Major, D.W., Mayfield, C.I., and Barker, J.F., 1988, Biotransformation of benzene by denitrification in aquifer sand: *Ground Water*, 26:8-14.
- Malone, D.R., Kao, C.M., and Borden, R.C., 1993, Dissolution and bioremediation of nonaqueous phase hydrocarbons - model development and laboratory evaluation: *Water Resour. Res.*, 29(7):2203-2213.
- March, J., 1985, *Advanced Organic Chemistry, 3rd edition*: Wiley, New York.
- Martel, 1987, *Military Jet Fuels 1944-1987*: AF Wright Aeronautical Laboratories, Wright-Patterson Air Force Base, OH.
- Martin, M., and Imbrigiotta, T.E., 1994, Contamination of ground water with trichloroethylene at the Building 24 site at Picatinny Arsenal, New Jersey. *In Symposium on Natural Attenuation of Ground Water, Denver, CO, August 30-September 1, 1994*: EPA/600/R-94/162, p. 109-115.
- Mayer, K.P., Grbić-Galić, D., Semprini, L., and McCarty, P.L., 1988, Degradation of trichloroethylene by methanotrophic bacteria in a laboratory column of saturated aquifer material: *Water Sci. Technol. (Great Britain)*, 20(11/12):75-178.
- Maymo-Gatell, X., Tandoi, V., Gossett, J.M., and Zinder, S.H., 1995, Characterization of an H₂-utilizing enrichment culture that reductively dechlorinates tetrachlorethene to vinyl chloride in the absence of methanogenesis acetogenesis: *Appl. Environ. Microbiol.*, 61: 3928-3933.

- McCall, P.J., Swann, R.L., and Laskowski, 1983, Partition models for equilibrium distribution of chemicals in environmental compartments, *In Fate of Chemicals in the Environment: American Chemical Society*: (Swann, R.L., and Eschenroder, A., Eds.), p. 105-123.
- McCarthy, K.A., and Johnson, R.L., 1992, Transport of volatile organic compounds across the capillary fringe: *Water Resour. Res.*, 29(6):1675-1683.
- McCarty, P.L., Reinhard, M., and Rittmann, B.E., 1981, Trace organics in groundwater: *Environ. Sci. Technol.*, 15(1):40-51
- McCarty, P.L., Roberts, P.V., Reinhard, M., and Hopkins, G., 1992, Movement and transformations of halogenated aliphatic compounds in natural systems, *In Fate of Pesticides and Chemicals in the Environment*: (Schnoor, J.L., Ed.), John Wiley & Sons, New York, p. 191-209.
- McCarty, P.L., and Semprini, L., 1994, Ground-water treatment for chlorinated solvents, *In Handbook of Bioremediation*: (Norris, R.D., Hinchee, R.E., Brown, R., McCarty, P.L., Semprini, L., Wilson, J.T., Kampbell, D.H., Reinhard, M., Bouwer, E.J., Borden, R.C., Vogel, T.M., Thomas, J.M., and Ward, C.H., Eds.), Lewis Publishers, Boca Raton, FL p. 87-116.
- McCarty, P.L., 1972, Energetics of organic matter degradation, *In Water Pollution Microbiology*: (R. Mitchell, Ed.), Wiley-Interscience, p. 91-118.
- McCarty, P.L., 1994, An Overview of Anaerobic Transformation of Chlorinated Solvents: *In Symposium on Intrinsic Bioremediation in Ground Water, Denver, CO, August 30 - September 1, 1994*, p.135-142.
- McDonald, G., and Harbaugh, A.W., 1988, A modular three-dimensional finite-difference groundwater flow model: U.S. Geological Survey Techniques of Water Resources Investigations, book 6, chapter A1.
- Mckenna, E. J., and Kallio, R.E., 1964, Hydrocarbon structure - its effect on bacterial utilization of alkanes, *In Principles and Applications in Aquatic Microbiology*: (Heukelian, H. and Dondero, W.C., Eds.), John Wiley & Sons, New York, p. 1-14.
- Means, J.C., Wood, S.G., Hassett, J.J., and Banwart, W.L., 1980, Sorption of polynuclear aromatic hydrocarbons by sediments and soils: *Environ. Sci. Technol.*, 14(12): 524-1528.
- Mercer, J.W., and Cohen, R.M., 1990, A review of immiscible fluids in the subsurface - properties, models, characterization and remediation: *J. Contam. Hydrol.*, 6:107-163.
- Mercer, J.W., and Faust, C.R., 1981, *Ground-water Modeling*: National Water Well Association, 60 p.
- Miller, C.T., Poirer-McNeill, M.M., and Mayer, A.S., 1990, Dissolution of trapped nonaqueous phase liquids: Mass transfer characteristics: *Water Resour. Res.*, 26:2783-2796.
- Miller, R.E., and Guengerich, F.P., 1982, Oxidation of trichloroethylene by liver microsomal cytochrome P-450: Evidence for chlorine migration in a transition state not involving trichloroethylene oxide: *Biochemistry*, 21:1090-1097.
- Miller, R.N., 1990, A field-scale investigation of enhanced petroleum hydrocarbon biodegradation in the vadose zone at Tyndall Air Force Base, Florida, *In Proceedings of the Petroleum Hydrocarbons and Organic Chemicals in Ground Water: Prevention, Detection, and Restoration Conference*: NWWA/API, p. 339 -351.
- Molz., F.J., Boman, G.K., Young, S.C., and Waldrop, W.R., 1994, Borehole flowmeters: Field application and data analysis: *J. Hydrol.*, 163:347-371.
- Molz., F.J. and Young, S.C., 1993, Development and application of borehole flowmeters for environmental assessment: *The Log Analyst*, v. 3, p. 13 - 23.

- Monod, J., 1942, *Recherches sur la Croissance des Cultures Bacteriennes*: Herman & Cie, Paris.
- Morel, F.M.M. and Hering, J.G., 1993, *Principles and Applications of Aquatic Chemistry*: John Wiley & Sons, New York.
- Murray, W.D. and Richardson, M., 1993, Progress toward the biological treatment of C₁ and C₂ halogenated hydrocarbons: *Crit. Rev. Environ. Sci. Technol.*, 23(3):195-217.
- National Research Council, 1993, *In Situ Bioremediation, When Does it Work?*: National Academy Press, Washington, D.C., 207 p.
- Naumov, G.B., Ryzhenko, B.N. and Khodakovskiy, I.L., 1974, *Handbook of Thermodynamic Data*: (translated from the Russian): U.S. Geol. Survey, USGS-WRD-74-001.
- Neely, W.B., 1985, Hydrolysis, *In Environmental Exposure from Chemicals, Vol. 1*: (Neely, W.B. and Blau, G.E., Eds.), CRC Press, Boca Raton, FL, p. 157-173.
- Nelson, M.J.K., Montgomery, S.O., Mahaffey, W.R., and Pritchard, P.H., 1987, Biodegradation of trichloroethylene and involvement of an aromatic biodegradative pathway: *Appl. Environ. Microbiol.*, 53(5):949-954.
- Nelson, M.J.K., Montgomery, S.O., O'Neill, E.J., and Pritchard, P.H., 1986, Aerobic metabolism of trichloroethylene by a bacterial isolate: *Appl. Environ. Microbiol.*, 52(2):383-384.
- Nelson, M.J.K., Montgomery, S.O., and Pritchard, P.H., 1988, Trichloroethylene metabolism by microorganisms that degrade aromatic compounds: *Appl. Environ. Microbiol.*, 54(2):604-606.
- Neumann, A., Scholz-Muramatsu, H., and Diekert, G., 1994, Tetrachloroethene metabolism of *Dehalorespirillum multivorans*: *Arch. Microbiol.*, 162:295-301.
- Newell, C.J., McLeod, R.K., and Gonzales, J.R., 1996, *Bioscreen: Natural Attenuation Decision Support System User's Manual, Version 1.3*, EPA/600/R-96/087.
- Newman, W.A., and Kimball, G., 1991, Dissolved oxygen mapping; A powerful tool for site assessments and groundwater monitoring: *In Proceedings of the Fifth National Outdoor Action Conference on Aquifer Restoration, Groundwater Monitoring, and Geophysical Methods*, Number 5, p. 103-117.
- Nishino, S.F., Spain, J.C., and Pettigrew, C.A., 1994, Biodegradation of chlorobenzene by indigenous bacteria: *Environ. Toxicol. Chem.*, 13:871-877.
- Norris, R.D., Hinchee, R.E., Brown, R., McCarty, P.L., Semprini, L., Wilson, J.T., Kampbell, D.H., Reinhard, M., Bouwer, E.J., Borden, R.C., Vogel, T.M., Thomas, J.M., and Ward, C.H., 1994, *Handbook of Bioremediation*: Lewis Publishers, Boca Raton, FL, 257 p.
- Oldenhuis, R., Oedzes, J.Y., van der Waarde, J.J., and Janssen, D.B., 1991, Kinetics of chlorinated hydrocarbon degradation by *Methylosinus trichosporum* OB3b and toxicity of trichloroethylene: *Appl. Environ. Microbiol.*, 57(7):7-14.
- Oldenhuis, R., Vink, R.L.J.M., Janssen, D.B., and Witholt, B., 1989, Degradation of chlorinated aliphatic hydrocarbons by *Methylosinus trichosporum* OB3b expressing soluble methane monooxygenase: *Appl. Environ. Microbiol.*, 55(11):2819-2826.
- Olsen, R.L., and Davis, A., 1990, Predicting the fate and transport of organic compounds in groundwater (Part I): *Hazardous Materials Control*, 3(3):39-64.
- Pankow, J.F., 1986, Magnitude of artifacts caused by bubbles and headspace in the determination of volatile compounds in water: *Anal. Chem.*, 58:1822-1826.
- Parker, J.C., and van Genuchten, 1984, Determining transport parameters from laboratory and field tracer experiments: *Virginia Agricultural Experiment Station, Bulletin*, 84-3.

- Parsons, F., Barrio-Lage, G., and Rice, R., 1985, Biotransformation of chlorinated organic solvents in static microcosms: *Environ. Toxicol. Chem.*, 4:739-742.
- Parsons, F., Wood., P.R., and DeMarco, J., 1984, Transformations of tetrachloroethene and trichloroethene in microcosms and groundwater: *J. Am. Water Works Assoc.*, 76:56-59.
- Payne, W.J., 1981, The status of nitric oxide and nitrous oxide as intermediates in denitrification: *In Denitrification, Nitrification, and Atmospheric Nitrous Oxide*: (Delwiche, C.C., Ed.), Wiley-Interscience, New York, p. 85-103.
- Perry, J.J, 1984, Microbial metabolism of cyclic alkanes, *In Petroleum Microbiology*: (Atlas, R.M., Ed.), Macmillan, New York, p. 61-67.
- Pickens, J.F., and Grisak, G.E., 1981, Scale-dependent dispersion in a stratified granular aquifer: *Water Resour. Res.*, 17(4):1191-1211.
- Postgate, J.R. 1984. *The Sulfate-reducing Bacteria*: Cambridge University Press, New York.
- Powers, S.E., Abriola, L.M., and Weber, W.J., Jr., 1992, Development of phenomenological models for NAPL dissolution processes, *In Proceedings of the Subsurface Restoration Conference: Dallas, Texas, June 21-24, 1992*: Rice U., Houston, p. 250-252.
- Prickett, T.A., and Lonquist, G., 1971, Selected digital computer techniques for groundwater resource evaluation: *Illinois State Water Survey Bulletin* 55, 62 p.
- Prickett, T.A., Naymik, T.G., and Lonquist, C.G., 1981, A “random walk” solute transport model for selected groundwater quality evaluations: *Illinois State Water Survey Bulletin* 65, 103 p.
- Puls, R.W., and Barcelona, M.J., 1996, *Low-flow (minimal drawdown) Ground-water Sampling Procedures*: EPA/540/S-95/504.
- Ramanand, K., Balba, M.T., and Duffy, J., 1993, Reductive dehalogenation of chlorinated benzenes and toluenes under methanogenic conditions: *Appl. Environ. Microbiol.*, 59:3266-3272.
- Rao, P.S.C., and Davidson, J.M., 1980, Estimation of pesticide retention and transformation parameters required in nonpoint source pollution models, *In Environmental Impact of Nonpoint Source Pollution*: (Overcash, M.R., and Davidson, J.M., Eds.), Ann Arbor Science Publishers, Ann Arbor, MI, p. 23-67.
- Reeves, M., and Cranwell, R.M., 1981, User’s manual for the Sandia waste-isolation flow and transport model: Report SAND81-2516 and NUREG/CR-2324, Sandia National Laboratories, Albuquerque, NM.
- Reineke, W., and Knackmuss, H.J., 1984, Microbial metabolism of haloaromatics: Isolation and properties of a chlorobenzene-degrading bacterium: *European J. Appl. Microbiol. Biotechnol.*, 47:395-402.
- Reinhard, M., Curtis, G.P., and Kriegman, M.R., 1990, *Abiotic Reductive Dechlorination of Carbon Tetrachloride and Hexachloroethane by Environmental Reductants*: Project Summary, EPA/600/S2-90/040, September 1990.
- Reinhard, M., Goodman, N.L., and Barker, J.F., 1984, Occurrence and distribution of organic chemicals in two landfill leachate plumes: *Environ. Sci. Technol.*, 18:953-961.
- Rice, D.W., Grose, R.D., Michaelsen, J.C., Dooher, B.P., MacQueen, D.H., Cullen, S.J., Kastenber, W.E., Everett, L.G., and Marino, M.A., 1995, California Leaking Underground Fuel Tank (LUFT) Historical Case Analyses: California State Water Resources Control Board.

- Rifai, H.S., Bedient, P.B., Borden, R.C., and Haasbeek, J.F., 1989, *Bioplume II - Computer Model of Two-dimensional Transport Under the Influence of Oxygen-limited Biodegradation in Groundwater (User's Manual Version 1.0, Preprocessor Service Code Version 1.0, Source Code Version 1.0)*: EPA/600/8-88/093, NTIS PB 89-151120.
- Rifai, H.S., Bedient, P.B., Wilson, J.T., Miller, K.M., and Armstrong, J.M., 1988, Biodegradation modeling at aviation fuel spill site: *J. Environ. Eng.*, 114(5):1007-1029.
- Riser-Roberts, E., 1992, *Bioremediation of Petroleum Contaminated Sites*: CRC Press, Boca Raton, FL, 461 p.
- Rittman, B.E. and McCarty, P.L., 1980, Utilization of dichloromethane by suspended and fixed-film bacteria: *Appl. Environ. Microbiol.*, 39(6):1225-1226.
- Rivett, M.O., 1995, Soil-gas signatures from volatile chlorinated solvents: Borden Field Experiments: *Ground Water*, 33(1):84-98.
- Roberts, P.V., Reinhard, M., and Valocchi, A.J., 1982, Movement of organic contaminants in groundwater: *J. Am. Water Works Assoc.*, 74(8):408-413.
- Roberts, P.V., Schreiner, J., and Hopkins, G.D., 1982. Field study of organic water quality changes during groundwater recharge in the Palo Alto Baylands: *Water Res.*, 16:1025-1035.
- Roy, W.R., Krapac, I.G., Chou, S.F.J., and Griffin, R.A., 1992, Batch-type procedures for estimating soil adsorption of chemicals: United States Environmental Protection Agency Technical Resource Document EPA/530-SW-87-006-F, 100 p.
- Sander, P., Wittaich, R.M., Fortnagel, P., Wilkes, H., and Francke, W., 1991, Degradation of 1,2,4-trichloro- and 1,2,4,5-tetrachlorobenzene by *Pseudomonas* strains: *Appl. Environ. Microbiol.*, 57:1430-1440.
- Saunders, F.Y., and Maltby, V., 1996, Degradation of chloroform under anaerobic soil conditions, *In Proceedings of the Symposium on Natural Attenuation of Chlorinated Organics in Ground Water, Dallas, TX, September 11-16, 1996*: EPA/540/R-96/509.
- Schaumburg, F.D., 1990. Banning trichloroethylene: Responsible reaction or overkill?: *Environ. Sci. Technol.*, 24:17-22.
- Scholz-Muramatsu, H., Szewzyk, R., Szewzyk, U. and Gaiser, S., 1990, Tetrachloroethylene as electron acceptor for the anaerobic degradation of benzoate: *FEMS Microbiol. Lett.*, 66:81-86.
- Schraa, G., Boone, M.L., Jetten, M.S.M., van Neerven, A.R.W., Colberg, P.J., and Zehnder, A.J.B., 1986, Degradation of 1,2-dichlorobenzene by *Alcaligenes sp.* strain A175: *Appl. Environ. Microbiol.*, 52:1374-1381.
- Schwarzenbach, R.P., Giger, W., Hoehn, E., and Schneider, J.K., 1983, Behavior of organic compounds during infiltration of river water to groundwater. Field studies: *Environ. Sci. Technol.*, 17(9):472-479.
- Schwarzenbach, R.P., and Westall, J., 1981, Transport of nonpolar organic compounds from surface water to groundwater. Laboratory sorption studies: *Environ. Sci. Technol.*, 15(11):1360-1367.
- Schwarzenbach, R.P., and Westall, J., 1985, Sorption of hydrophobic trace organic compounds in groundwater systems: *Water Sci. Technol.*, 17(8):39-55.
- Sellers, K.L., and Schreiber, R.P., 1992, Air sparging model for predicting groundwater clean up rate: *In Proceedings of the 1992 NGWA Petroleum Hydrocarbons and Organic Chemicals in Ground Water, Prevention, Detection, and Restoration Conference*, November, 1992.

- Sewell, G.W., and Gibson, S.A., 1990, Reductive Dechlorination of Tetrachloroethene and Trichloroethene Linked to Anaerobic Degradation of Toluene in Fuel and Solvent Contaminated Aquifer Material. Abstracts of the Annual Meeting of the American Society for Microbiology, Anaheim, CA, 14-18 May, 1990.
- Sewell, G.W., Wilson, B.H., Wilson, J.T., Kampbell, D.H. and Gibson, S.A., 1991, Reductive dechlorination of tetrachloroethene and trichloroethene in fuel spill plumes. *In Chemical and Biochemical Detoxification of Hazardous Waste II: (Glaser, J.A., Ed.)*, Lewis Publishers, Chelsea, MI, in press.
- Sewell, G.W., and Gibson, S.A., 1991, Stimulation of the reductive dechlorination of tetrachloroethene in anaerobic aquifer microcosms by the addition of toluene: *Environ. Sci. Technol.*, 25(5):982-984.
- Sharma, P.K., and McCarty, P.L., 1996, Isolation and characterization of a facultatively aerobic bacterium that reductively dehalogenates tetrachloroethene to cis-1,2-dichloroethene: *Appl. Environ. Microbiol.*, 62:761-765.
- Shiu, W.Y., Maijanen, A., Ng, L.Y., and Mackay, D., 1988, Preparation of aqueous solutions of sparingly soluble organic substances: II. Multicomponent systems - Hydrocarbon mixtures and petroleum products: *Environ. Toxicol. Chem.*, 7:125-137.
- Singer, M.E., and Finnerty, W.R., 1984, Microbial metabolism of straight-chain and branched alkanes, *In Petroleum Microbiology: (Atlas, R.M., Ed.)*, Macmillan, New York, p. 1-59.
- Smatlak, C.R., Gossett, J.M., and Zinder, S.H., 1996, Comparative kinetics of hydrogen utilization for reductive dechlorination of tetrachloroethene and methanogenesis in an anaerobic enrichment culture: *Environ. Sci. Technol.*, 30:2850-2858.
- Smith, J.H., Harper, J.C., and Jaber, H., 1981, Analysis and environmental fate of Air Force distillate and high density fuels: Report No. ESL-TR-81-54, Tyndall Air Force Base, FL, Engineering and Services Laboratory.
- Smith, M.R., 1990, The biodegradation of aromatic hydrocarbons by bacteria: *Biodegradation*, 1:191-206.
- Snoeyink, V.L. and Jenkins, D., 1980, *Water Chemistry*: John Wiley & Sons, New York.
- Spain, J.C., and Nishino, S.F., 1987, Degradation of 1,4-dichlorobenzene by a *Pseudomonas sp.*: *Appl. Environ. Microbiol.*, 53:1010-1019.
- Spain, J.C., 1996, Future vision: Compounds with potential for natural attenuation, *In Proceedings of the Symposium on Natural Attenuation of Chlorinated Organics in Ground Water, Dallas TX, September 11-13, 1996: EPA /540/R-96/509.*
- Spitz, K., and Moreno, J., 1996, *A Practical Guide to Groundwater and Solute Transport Modeling*: John Wiley & Sons, New York, 461 p.
- Srinivasan, P., and Mercer, J.W., 1988, Simulation of biodegradation and sorption processes in groundwater: *Ground Water*, 26(4):475-487.
- Starr, R.C. and Gillham, R.W., 1993, Denitrification and organic carbon availability in two aquifers: *Ground Water*, 31(6):934-947.
- Stauffer, T.B., Antworth, T.B., Boggs, J.M., and MacIntyre, W.G., 1994, A Natural Gradient Tracer Experiment in a Heterogeneous Aquifer with Measured In Situ Biodegradation Rates: A Case for Natural Attenuation: *Symposium on Natural Attenuation of Ground Water: EPA/600/R-94/162, September 1994.* p. 68-74.
- Stookey, L.L., 1970, Ferrozine-A new spectrophotometric reagent for iron: *Analy. Chem.*, 42:779-781.

- Stotzky, G., 1974, Activity, ecology, and population dynamics of microorganisms in soil, *In Microbial Ecology*: (Laskin, A., and Lechevalier, H., Eds.), CRC Press, Cleveland, p. 57-135.
- Strack, O.D.L., 1989, *Groundwater Mechanics*: Prentice-Hall, Englewood Cliffs, NJ, 732 p.
- Stucki, J.W., Komadel, P., and Wilkinson, H.T., 1987, Microbial reduction of structural iron (III) in smectites: *Soil Sci. Soc. Am. J.*, 51:1663-1665.
- Stucki, G., Krebsler, U., and Leisinger, T., 1983, Bacterial growth on 1,2-dichloroethane: *Experientia*, 39:1271-1273.
- Stucki, J.W., Low, P.F., Roth, C.B., and Golden, D.C., 1984, Effects of oxidation state of octahedral iron on clay swelling: *Clays and Clay Minerals*, 32:357-362.
- Stumm, W., and Morgan, J.J., 1981, *Aquatic Chemistry*: John Wiley & Sons, New York.
- Suflita, J.M., Gibson, S.A., and Beeman, R.E., 1988, Anaerobic biotransformations of pollutant chemicals in aquifers: *J. Ind. Microbiol.*, 3:179-194.
- Suflita, J.M., and Townsend, G.T., 1995, The microbial ecology and physiology of aryl dehalogenation reactions and implications for bioremediation, *In Microbial Transformation and Degradation of Toxic Organic Chemicals*: (Young, L.Y., and Cerniglia, C.E., Eds.), Wiley-Liss, New York, 654 p.
- Sun, Y., Petersen, J.N., Clement, T.P., and Hooker, B.S., 1996, A modular computer model for simulating natural attenuation of chlorinated organics in saturated ground-water aquifers, *In Proceedings of the Symposium on Natural Attenuation of Chlorinated Organics in Ground Water, Dallas, TX, September 11-13, 1996*: EPA/540/R-96/509.
- Sutton, C., and Calder, J.A., 1975, Solubility of higher-molecular weight n-paraffins in distilled water and seawater: *J. Chem. Eng. Data*, 20:320-322.
- Swanson, M., Wiedemeier, T.H., Moutoux, D.E., Kampbell, D.H., and Hansen, J.E., 1996, Patterns of natural attenuation of chlorinated aliphatic hydrocarbons at Cape Canaveral Air Station, Florida, *In Proceedings of the Symposium on Natural Attenuation of Chlorinated Organics in Ground Water, Dallas, TX, September 11-13, 1996*: EPA/540/R-96/509.
- Swindoll, M.C., Aelion, C.M., and Pfaender, F.K., 1988, Influence of inorganic and organic nutrients on aerobic biodegradation and on the adaptation response of subsurface microbial communities: *Appl. Environ. Microbiol.*, 54(1):221-217.
- Tabak, H.H., Quave, S.A., Mashni, C.I., and Barth, E.F., 1981, Biodegradability studies with organic priority pollutant compounds: *J. Water Pollut. Contr. Fed.*, 53:1503-1518.
- Testa, S.M., and Paczkowski, M.T., 1989, Volume determination and recoverability of free hydrocarbon: *Ground Water Monit. Rev.*, Winter 1989, p. 120-128.
- Thierrin, J., Davis, G.B., Barber, C., Patterson, B.M., Pribac, F., Power, T.R., and Lambert, M., 1992, Natural degradation rates of BTEX compounds and naphthalene in a sulfate reducing groundwater environment, *In In-Situ Bioremediation Symposium "92", Niagara-on-the-Lake, Ontario, Canada, September 20-24, 1992*: in press.
- Tiedje, J.M. and Stevens, T.O., 1988, The Ecology of an Anaerobic Dechlorination Consortium. *In Environmental Biotechnology: Reducing Risks from Environmental Chemicals Through Biotechnology*: (Omen, G.S., Ed.), Plenum Press, New York. p. 3-14.
- Trudgill, P.W., 1984, Microbial degradation of the alicyclic ring: structural relationships and metabolic pathways, *In Microbial Degradation of Organic Compounds*: (Gibson, D.T., Ed.), Marcel Dekker, New York, p. 131-180.

- Tsien, H.C., Brusseau, G.A., Hanson, R.S., and Wackett, L.P., 1989, Biodegradation of trichloroethylene by *Methylosinus trichosporum*: *Appl. Environ. Microbiol.*, 55(12):3155-3161.
- U.S. Council on Environmental Quality, 1981, *Contamination of Groundwater by Toxic Organic Chemicals*: U.S. Government Printing Office, Washington, D.C
- U.S. Environmental Protection Agency, 1986, Background Document for the Ground-Water Screening Procedure to Support 40 CFR Part 269 - Land Disposal: EPA/530-SW-86-047, January 1986.
- U.S. Environmental Protection Agency, 1987, A Compendium of Superfund Field Methods. EPA/540/P-87/001A. OSWER Directive 9355.0-14.
- U.S. Environmental Protection Agency, 1990, Groundwater - Volume 1: Groundwater and Contamination: EPA/625/6-90/016A.
- U.S. Environmental Protection Agency, 1991a, *Handbook of Suggested Practices for the Design and Installation of Ground-Water Monitoring Wells*: EPA/600/4-89/034, 221 pp.
- U.S. Environmental Protection Agency, 1992b, Contract Laboratory Program Statement of Work for Inorganics Analyses, Multi-Media, Multi-Concentration. Document Number ILM03.0.
- U.S. Environmental Protection Agency, 1997, Use of Monitoring Natural Attenuation at Superfund, RCRA Corrective Action, and Underground Storage Tank Sites. Office of Solid Waste and Emergency Response Directive 9200.4-17.
- van der Meer, J.R., Roelofsen, W., Schraa, G., and Zehnder, A.J.B., 1987, Degradation of low concentrations of dichlorobenzenes and 1,2,4-trichlorobenzene by *Pseudomonas* sp. strain P51 in nonsterile soil columns: *FEMS Microbiol. Lett.*, 45:333-341.
- van Genuchten, M. Th. and Alves, W.J., 1982, *Analytical Solutions of the One-Dimensional Convective-Dispersive Solute Transport Equation*: U.S. Department of Agriculture, Technical Bulletin Number 1661, 151 p.
- Vanelli, T., Logan, M., Arciero, D.M., and Hooper, A.B., 1990, Degradation of halogenated aliphatic compounds by the ammonia-oxidizing bacterium *Nitrosomonas europaea*: *Appl. Environ. Microbiol.*, 56(4):1169-1171.
- Vogel, T.M., Criddle, C.S., and McCarty, P.L., 1987, Transformations of halogenated aliphatic compounds: *Environ. Sci. Technol.*, 21(8):722-736.
- Vogel, T. M., and Grbić-Galić, D., 1986, Incorporation of oxygen from water into toluene and benzene during anaerobic fermentative transformation: *Appl. Environ. Microbiol.*, 52:200-202.
- Vogel, T.M., and McCarty, P.L., 1987, Abiotic and biotic transformations of 1,1,1-trichloroethane under methanogenic conditions: *Environ. Sci. Technol.*, 21(12):1208-1213.
- Vogel, T.M., and McCarty, P.L., 1985, Biotransformation of tetrachloroethylene to trichloroethylene, dichloroethylene, vinyl chloride, and carbon dioxide under methanogenic conditions: *Appl. Environ. Microbiol.*, 49(5):1080-1083.
- Vogel, T.M., and Reinhard, M., 1986, Reaction products and rates of disappearance of simple bromoalkanes, 1,2-dibromopropane and 1,2-dibromoethane in water: *Environ. Sci. Technol.*, 20(10):992-997.
- Vogel, T.M., 1994, Natural bioremediation of chlorinated solvents, *In Handbook of Bioremediation*: (Norris, R.D., Hinchee, R.E., Brown, R., McCarty, P.L., Semprini, L., Wilson, J.T., Kampbell, D.H., Reinhard, M., Bouwer, E.J., Borden, R.C., Vogel, T.M., Thomas, J.M., and Ward, C.H., Eds.), Lewis Publishers, Boca Raton, FL, p. 201-225.

- von Gunten, U., and Zobrist, J., 1993, Biogeochemical changes in groundwater-infiltration systems - Column Studies: *Geochimica et Cosmochimica Acta*, 57:3895-3906.
- Vroblesky, D.A., and Chapelle, F.H., 1994, Temporal and spatial changes of terminal electron-accepting processes in a petroleum hydrocarbon-contaminated aquifer and the significance for contaminant biodegradation: *Water Resour. Res.*, 30(5):1561-1570.
- Wackett, L.P., Brusseau, G.A., Householder, S.R., and Hanson, R.S., 1989, Survey of microbial oxygenases: Trichloroethylene degradation by propane-oxidizing bacteria: *Appl. Environ. Microbiol.*, 55(11):2960-2964.
- Wackett, L.P. and Gibson, D.T., 1988, Degradation of trichloroethylene by toluene dioxygenase in whole-cell studies with *Pseudomonas putida* F1: *Appl. Environ. Microbiol.*, 54(7):1703-1708.
- Wackett, L.P., 1995, Bacterial co-metabolism of halogenated organic compounds, *In Microbial Transformation and Degradation of Toxic Organic Chemicals*: (Young, L.Y., and Cerniglia, C.E., Eds.), Wiley-Liss, New York, 654 p.
- Walton, W.C., 1988, *Practical Aspects of Groundwater Modeling*: National Water Well Association, Worthington, OH, 587 p.
- Walton, W.C., 1991, *Principles of Groundwater Engineering*: Lewis Publishers, Chelsea, MI, 546 p.
- Wang, T.C., and Tan, C.K., 1990, Reduction of halogenated hydrocarbons with magnesium hydrolysis process: *Bull. Environ. Contam. Toxicol.*, 45:149-156.
- Weaver, J.W., Wilson, J.T., and Kampbell, D.H., 1995, *Natural Attenuation of Trichloroethene at the St. Joseph, Michigan Superfund Site*, EPA Project Summary: EPA/600/SV-95/001, U.S. EPA, Washington, D.C.
- Weaver, J.W., Wilson, J.T., and Kampbell, D.H., 1996, Case study of natural attenuation of trichloroethene at St. Joseph, Michigan, *In Proceedings of the Symposium on Natural Attenuation of Chlorinated Organics in Ground Water, Dallas, TX, September 11-13, 1996*: EPA/540/R-96/509.
- Weaver, J.W., Wilson, J.T., and Kampbell, D.H., 1996, Extraction of degradation rate constants from the St. Joseph, Michigan, trichloroethene site, *In Proceedings of the Symposium on Natural Attenuation of Chlorinated Organics in Ground Water, Dallas, TX, September 11-13, 1996*: EPA/540/R-96/509.
- Westerick, J.J., Mello, J.W., and Thomas, R.F., 1984, The groundwater supply survey: *J. Am. Water Works Asso.*, 76:52-59.
- Wexler, E.J., 1992, Analytical solutions for one-, two-, and three-dimensional solute transport in ground-water systems with uniform flow: United States Geological Survey, *Techniques of Water-Resources Investigations of the United States Geological Survey*, Book 3, Chapter B7, 190 p.
- Wiedemeier, T.H., Benson, L.A., Wilson, J.T., Kampbell, D.H., Hansen, J.E., and Miknis, R., 1996a, Patterns of natural attenuation of chlorinated aliphatic hydrocarbons at Plattsburgh Air Force Base, New York: Platform Abstract of the Conference on Intrinsic Remediation of Chlorinated Solvents, Salt Lake City, UT, April 2, 1996.
- Wiedemeier, T.H., Blicker, B., and Guest, P.R., 1994b, Risk-based approach to bioremediation of fuel hydrocarbons at a major airport: Federal Environmental Restoration III & Waste Minimization Conference & Exhibition.

- Wiedemeier, T.H., Guest, P.R., Henry, R.L., and Keith, C.B., 1993, The use of Bioplume to support regulatory negotiations at a fuel spill site near Denver, Colorado, *In Proceedings of the Petroleum Hydrocarbons and Organic Chemicals in Ground Water: Prevention, Detection, and Restoration Conference: NWWA/API*, p. 445 -459.
- Wiedemeier, T.H., Miller, R.N., Wilson, J.T., and Kampbell, D.H., 1994a, Proposed Air Force guidelines for successfully supporting the natural attenuation (natural attenuation) option at fuel hydrocarbon contaminated sites: Presented at the 1994 NWWA/API Outdoor Action Conference.
- Wiedemeier, T.H., Swanson, M.A., Wilson, J.T., Kampbell, D.H., Miller, R.N., and Hansen, J.E., 1995b, Patterns of intrinsic bioremediation at two United States Air Force Bases, *In Intrinsic Bioremediation: (Hinchee, R.E., Wilson, J.T. and Downey, D.C., Eds.)*, Battelle Press, Columbus, OH.
- Wiedemeier, T.H., Swanson, M.A., Wilson, J.T., Kampbell, D.H., Miller, R.N., and Hansen, J.E., 1996b, Approximation of biodegradation rate constants for monoaromatic hydrocarbons (BTEX) in ground water: *Ground Water Monit. Remed.*, 16(3):186-194.
- Wiedemeier, T.H., Wilson, J.T., and Miller, R.N., 1995c, Significance of Anaerobic Processes for the Intrinsic Bioremediation of Fuel Hydrocarbons: *In Proceedings of the Petroleum Hydrocarbons and Organic Chemicals in Ground Water: Prevention, Detection, and Restoration Conference: NWWA/API*.
- Wiedemeier, T.H., Wilson, J.T., and Kampbell, D.H., 1996c, Natural attenuation of chlorinated aliphatic hydrocarbons at Plattsburgh Air Force Base, New York, *In Proceedings of the Symposium on Natural Attenuation of Chlorinated Organics in Ground Water, Dallas, TX, September 11-13, 1996: EPA/540/R-96/509*.
- Wiedemeier, T.H., Wilson, J.T., Kampbell, D.H., Miller, R.N., and Hansen, J.E., 1995d, Technical protocol for implementing intrinsic remediation with long-term monitoring for natural attenuation of fuel contamination dissolved in groundwater: U.S. Air Force Center for Environmental Excellence, San Antonio, TX.
- Willey, L.M., Kharaka, Y.K., Presser, T.S., Rapp, J.B., and Barnes, Ivan, 1975, Short chain aliphatic acid anions in oil field waters and their contribution to the measured alkalinity: *Geochimica et Cosmochimica Acta*, 39:1707-1711.
- Wilson, B.H., Ehlke, T.A., Imbrigiotta, T.E., and Wilson, J.T., 1991, Reductive dechlorination of trichloroethylene in anoxic aquifer material from Picatinny Arsenal, New Jersey, *In Proceedings of the U.S. Geological Survey Toxic Substances Hydrology Program, Monterey, CA: (Mallard, G.E., and Aronson, D.A., Eds.)*, Water Resources Investigation Report 91-4034, p. 704-707.
- Wilson, B.H., Wilson, J.T., Kampbell, D.H., Bledsoe, B.E., and Armstrong, J.M., 1990, Biotransformation of monoaromatic and chlorinated hydrocarbons at an aviation gasoline spill site: *Geomicrobiology J.*, 8:225-240.
- Wilson, B.H., Bledsoe, B., and Kampbell, D., 1987, Biological processes occurring at an aviation gasoline spill site, *In Chemical Quality of Water and the Hydrologic Cycle: (Averett, R.C. and Mcknight, D.M., Eds.)*, Lewis Publishers, Chelsea, MI, p. 125-137.
- Wilson, B. H., Smith, G.B., and Rees, J.F., 1986, Biotransformations of selected alkylbenzenes and halogenated aliphatic hydrocarbons in methanogenic aquifer material - A microcosm study: *Environ. Sci. Technol.*, 20:997-1002.

- Wilson, B.H., Wilson, J.T., and Luce, D., 1996, Design and interpretation of microcosm studies for chlorinated compounds, *In Proceedings of the Symposium on Natural Attenuation of Chlorinated Organics in Ground Water, Dallas, TX, September 11-13, 1996*: EPA/540/R-96/509.
- Wilson, B.H., 1988, Biotransformation of Chlorinated Hydrocarbons and Alkylbenzenes in Aquifer Material from the Picatinny Arsenal, New Jersey. Proceedings of the Technical Meeting, Phoenix, Arizona, September 26-30, 1988. U.S. GSWRIR 88-4220.389-394.
- Wilson, J.L., and Miller, P.J., 1978, Two-dimensional plume in uniform ground-water flow: American Society of Civil Engineers, J. Hydr. Div., 104(HY4):503-514.
- Wilson, J.T., Leach, L.E., Henson, M., and Jones, J.N., 1986, In Situ bioremediation as a groundwater remediation technique: *Ground Water Monit. Rev.*, Fall 1986, p. 56-64.
- Wilson, J.T., Kampbell, D.H., and Armstrong, J., 1993, Natural bioreclamation of alkylbenzenes (BTEX) from a gasoline spill in methanogenic groundwater: *In Proceedings of the Environmental Restoration Technology Transfer Symposium*, San Antonio, TX.
- Wilson, J.T., Kampbell, D., Weaver, J., Wilson, B., Imbrigiotta, T., and Ehlke, T., 1995, A review of intrinsic bioremediation of trichloroethylene in ground water at Picatinny arsenal, New Jersey, and St. Joseph, Michigan; *Symposium on Bioremediation of Hazardous Wastes: Research, Development, and Field Evaluations*: U.S. EPA, Rye Brook, NY August 1995: EPA/600/R-95/076.
- Wilson, J.T., Kampbell, D.H., and Weaver, J.W., 1996, Environmental chemistry and kinetics of biotransformation of chlorinated organic compounds in ground water: *In Proceedings of the Symposium on Natural Attenuation of Chlorinated Organics in Ground Water, Dallas, TX, September 11-13, 1996*: EPA/540/R-96/509.
- Wilson, J.T., McNabb, J.F., Wilson, B.H., and Noonan, M.J., 1982, Biotransformation of selected organic pollutants in groundwater: *Develop. Ind. Microbiol.*, 24:225-233.
- Wilson, J.T., McNabb, J.F., Balkwill, D.L., and Ghiorse, W.C., 1983, Enumeration and characteristics of bacteria indigenous to a shallow water-table aquifer: *Ground Water*, 21:134-142.
- Wilson, J.T., McNabb, J.F., Cochran, J.W., Wang, T.H., Tomson, M.B., and Bedient, P.B., 1985, Influence of microbial adaptation on the fate of organic pollutants in groundwater: *Environ. Toxicol. Chem.*, 4:721-726.
- Wilson, J.T., Pfeffer, F.M., Weaver, J.W., Kampbell, D.H., Wiedemeier, T.H., Hansen, J.E., and Miller, R.N., 1994, Intrinsic bioremediation of JP-4 jet fuel: United States Environmental Protection Agency, *Symposium on Natural Attenuation of Ground Water*, EPA/600/R-94/162, p. 60-67.
- Wilson, J.T., and Wilson, B.H., 1985, Biotransformation of trichloroethylene in soil: *Appl. Environ. Microbiol.*, 49(1):242-243.
- Wilson, J.T., 1988, Degradation of halogenated hydrocarbons: *Biotec.*, 2:75-77.
- Wood, P.R., Lang, R.F., and Payan, I.L., 1985, Anaerobic transformation, transport, and removal of volatile chlorinated organics in ground water, *In Ground Water Quality*: (Ward, C.H., Giger, W., and McCarty, P.L., Eds.), John Wiley & Sons, New York, p. 493-511.
- Wu, J., Roth, C.B., and Low, P.F., 1988, Biological reduction of structural iron in sodium-nontronite: *Soil Sci. Soc. Am. J.*, 52:295-296.
- Xu, M., and Eckstein, Y., 1995, Use of weighted least-squares method in evaluation of the relationship between dispersivity and scale: *Ground Water*, 33(6):905-908.

- Young, L.Y., 1984, Anaerobic degradation of aromatic compounds, *In Microbial Degradation of Aromatic Compounds*: (Gibson, D.R., Ed.), Marcel-Dekker, New York.
- Young, S.C., 1995, Characterization of high-K pathways by borehole flowmeter and tracer tests: *Ground Water*, 33(2):311-318.
- Young, S.C. and Pearson, H.S., 1995, The electromagnetic borehole flowmeter: Description and application: *Groundwater Monit. Remed.*, Fall 1995, p.138-147.
- Zehnder, A.J.B., 1978, Ecology of methane formation, *In Water Pollution Microbiology*: (Mitchell, R., Ed.), Wiley, New York, p. 349-376.
- Zeyer, J., Kuhn, E.P., and Schwarzenbach, R.P., 1986, Rapid microbial mineralization of toluene and 1,3 dimethylbenzene in the absence of molecular oxygen: *Appl. Environ. Microbiol.*, 52:944-947.

APPENDIX A

FIELD INVESTIGATION METHODOLOGIES

TABLE OF CONTENTS - APPENDIX A

A-1	INTRODUCTION	A1-4
A-2	SUBSURFACE INVESTIGATION METHODOLOGIES	A2-5
A.2.1	TRADITIONAL DRILLING TECHNIQUES	A2-5
A.2.2	CONE PENETROMETER TESTING	A2-6
A.2.3	HYDRAULIC PERCUSSION SYSTEMS	A2-7
A-3	SOIL CHARACTERIZATION METHODOLOGIES	A3-8
A.3.1	SAMPLE ACQUISITION	A3-8
A.3.2	PHYSICAL DESCRIPTION	A3-8
A.3.3	FIXED-BASE LABORATORY ANALYSES	A3-9
A-4	GROUND-WATER CHARACTERIZATION METHODOLOGIES	A4-10
A.4.1	GROUND-WATER MONITORING LOCATIONS, DEPTHS, AND SCREENED INTERVALS	A4-10
A.4.2	TYPES OF GROUND-WATER SAMPLING LOCATIONS	A4-10
A.4.2.1	Monitoring Wells	A4-11
A.4.2.2	Monitoring Points	A4-11
A.4.2.3	Grab Sampling	A4-12
A.4.3	MEASUREMENT OF STATIC FLUID LEVELS	A4-12
A.4.3.1	Water Level and Total Depth Measurements	A4-12
A.4.3.2	Mobile LNAPL Thickness Measurements	A4-13
A.4.3.4	Mobile DNAPL Thickness Measurements	A4-13
A.4.3	GROUND-WATER EXTRACTION	A4-13
A.4.3.1	Methods	A4-13
A.4.3.2	Development	A4-14
A.4.3.3	Purging	A4-15
A.4.3.4	Sampling	A4-16
A.4.4	GROUND-WATER ANALYTICAL PROCEDURES	A4-17
A.4.4.1	Standard Well Head Analyses	A4-18
A.4.4.2	Dissolved Hydrogen Analysis	A4-18
A.4.4.2.1	Sampling Method	A4-18
A.4.4.2.2	Analytical Method	A4-19
A.4.4.3	Field Analytical Laboratory Analyses	A4-20
A.4.4.4	Fixed-Base Laboratory Analyses	A4-22
A-5	SURFACE WATER AND SEDIMENT CHARACTERIZATION METHODOLOGIES	A5-23
A.5.1	Surface Water Sample Collection	A5-23
A.5.2	Sediment Sample Collection	A5-23
A-6	SAMPLE HANDLING	A6-24
A.6.1	SAMPLE PRESERVATION, CONTAINERS, AND LABELS	A6-24
A.6.2	SAMPLE SHIPMENT	A6-24
A.6.3	CHAIN-OF-CUSTODY CONTROL	A6-24
A.6.4	SAMPLING RECORDS	A6-25

A-7	AQUIFER CHARACTERIZATION METHODOLOGIES	A7-26
A.7.1	HYDRAULIC CONDUCTIVITY	A7-26
A.7.1.1	Pump Tests	A7-26
A.7.1.1.1	Pumping Test Design	A7-26
A.7.1.1.2	Preparation for Testing	A7-27
A.7.1.1.3	Conducting the Pumping Test	A7-28
A.7.1.2	Slug Tests	A7-29
A.7.1.3	Downhole Flow Meter Measurements	A7-30
A.7.2	HYDRAULIC GRADIENT	A7-31
A.7.3	DIRECT MEASUREMENT OF GROUND-WATER VELOCITY	A7-31

FIGURES

No.	Title	Page
A.4.1	Overflow Cell to Prevent Alteration of Geochemical Properties of Ground Water by Exposure to the Atmosphere	A4-17
A.4.2	Flowthrough Cell to Prevent Alteration of Geochemical Properties of Ground Water by Exposure to the Atmosphere	A4-17
A.4.3	Schematic Showing the “Bubble Strip” Method for Measuring Dissolved Hydrogen Concentrations in Ground water	A4-19

SECTION A-1

INTRODUCTION

Detailed site characterization is an important aspect of the remediation by monitored natural attenuation. Typically, it is necessary to collect additional site-specific data in order to successfully complete the demonstration. This appendix presents an overview of field techniques that can be used to collect the data used to evaluate monitored natural attenuation. These techniques are most appropriate for aquifers in unconsolidated sediments. They are less appropriate for fractured rock, and karst hydrogeologic settings. Selection of locations for field investigation activities and analytical protocols used for soil and water samples are discussed in Section 2 of the protocol document.

During all field investigation activities, special care should be taken to prevent contamination of the sampled matrices. The primary way that sample contamination can occur is through contact with improperly cleaned equipment. To prevent such contamination, proper equipment decontamination procedures must be developed and followed. Procedures will vary according to site contaminants, equipment type, field activity, sample matrix, rinseate handling requirements, and regulatory requirements. All equipment requires decontamination prior to initiation of site activities and between sampling locations. New, disposable equipment does not require decontamination if factory-sealed and found acceptable according to the appropriate data quality objectives and the site specific Quality Assurance Plan. In addition to the use of properly cleaned equipment, new, clean, disposable gloves (of a material appropriate to the activity and contaminant type/concentration) should be worn at each new sampling location.

Basic health and safety precautions are required for every piece of equipment and every methodology discussed in this section. It is the responsibility of the investigator to be aware of and to communicate all health and safety issues to the field team; therefore, a site specific health and safety plan must be developed prior to initiating investigation activities. At a minimum this plan must contain:

- A safety and health risk analysis for chemical, physical, and biological hazards associated with the site conditions, anticipated contaminants, equipment, field activities, and climate;
- An emergency response plan with applicable emergency response numbers; and
- Precautionary measures to be implemented to insure the safety of site workers.

This appendix consists of seven sections, including this introduction. Section A-2 discusses subsurface investigation methodologies. Section A-3 discusses soil characterization methodologies. Section A-4 discusses groundwater characterization methodologies. Section A-5 discusses surface water and sediment characterization methodologies. Section A-6 discusses sample handling procedures. Section A-7 discusses aquifer characterization methodologies.

SECTION A-2

SUBSURFACE INVESTIGATION METHODOLOGIES

The ideal technologies for an investigation of monitored natural attenuation are those which can rapidly provide a large amount of information in a very short period of time while producing low quantities of waste. The following subsections briefly introduce several alternatives that are available for performing subsurface investigations to evaluate remediation by monitored natural attenuation. Although some of these alternatives more closely achieve the objectives of remediation by monitored natural attenuation investigation than others, considerations such as site geology, site hydrogeology, future well use, or regulatory concerns may dictate the selection of the subsurface investigation method for any given site. It is crucial to the evaluation of monitored natural attenuation to consider all of these issues prior to selecting a technology appropriate for their site. If during the investigation it becomes necessary to change methodologies, the same concerns must be re-addressed.

Prior to initiating any intrusive subsurface activities, proposed drilling locations must be cleared. It is particularly useful if all utility lines in the investigation area are marked should changes to the investigation become necessary. In addition, in order to expedite the investigation, all necessary digging, coring, drilling, and ground-water monitoring point installation permits should be obtained prior to mobilizing to the field. Care should be taken not to cross-contaminate deeper aquifers by drilling through an aquitard underlying a DNAPL.

At the conclusion of subsurface investigations, each sampling location that is not used to install a ground-water monitoring point or well should be restored as closely to its original condition as possible. Where possible, holes should be sealed with bentonite chips, pellets, or grout to eliminate any creation or enhancement of contaminant migration pathways to the ground water.

A.2.1 TRADITIONAL DRILLING TECHNIQUES

Traditional drilling techniques include those methods that traditionally have been used to install drinking water supply wells. Examples of traditional drilling techniques include hollow stem auger, rotary, air percussion, and cable tool or chain tool. They have in common the advantage of being capable of installing wells of varying diameters to drinking water well specifications. Each of these techniques also allows for visual description of the materials and can allow for easy stratigraphic correlation. In general, the equipment required by each of these techniques is readily available. Disadvantages of traditional drilling techniques include their expense, time requirements, and waste generation. Not only do these techniques produce soil/fluids from the drilling process, frequently, in order to properly develop wells by these techniques, a large volume of ground water must be extracted during a lengthy development. Although the advantages and disadvantages listed above are common to most traditional drilling techniques, they are applicable to varying degrees. Furthermore, drilling depth and subsurface stratigraphy are important considerations when evaluating the efficacy of each of these techniques.

Hollow-stem auger has been the most widely used traditional drilling technique in environmental investigations, because it is very effective in the most commonly investigated geologic setting encountered during environmental investigations: unconsolidated deposits at shallow depths. Although less common, a chain tool can also be effective under similar geologic conditions. When installing wells, a chain tool may require a little more time, but may prove to be less disruptive to the formation in the vicinity of the well screen. Both techniques are well suited to collecting continuous soil samples using a split-barrel continuous sampling device. This capability is extremely important because detailed knowledge of the subsurface can be critical to the successful demonstration of remediation by monitored natural attenuation.

At greater depths and in more competent formations, rotary and air hammer techniques are frequently used. Rotary techniques are also suited to penetration of cobbly units that may prove difficult or impenetrable to a hollow-stem auger or chain tool. With rotary rigs, the fastest drilling rates are usually achieved by using drilling fluids such as mud or water; however, these fluids may require handling as IDW and may clog the pore space in the vicinity of the well screen. As long as air circulation can be maintained in the borehole, an air hammer can be particularly useful in competent bedrock formations without introducing drilling fluids.

A.2.2 CONE PENETROMETER TESTING

CPT is increasingly being used for successful site characterization. CPT is accomplished using a cone penetrometer truck, which consists of an instrumented probe that is forced into the ground using a hydraulic load frame mounted on a heavy truck, with the weight of the truck providing the necessary force. Penetration force is typically supplied by a pair of large hydraulic cylinders bolted to the truck frame. In tight soils, push capacity is more often limited by the structural bending capacity of the push rods than by the weight of the truck. Cone penetrometers operate well in most unconsolidated deposits; however, they may not be able to penetrate and may be damaged by cobbles, gravel layers, very stiff clays, and cemented units.

The penetrometer probe generally consists of a 60-degree conical tip attached to a friction sleeve. Inside the probe, two load cells independently measure the vertical resistance against the conical tip and the side friction along the sleeve. Each load cell is a cylinder of uniform cross section inside the probe which is instrumented with four strain gauges in a full-bridge circuit. Forces are sensed by the load cells, and the data are transmitted from the probe assembly via a cable running through the push tubes. The analog data are digitized, recorded, and plotted by computer in the penetrometer truck. Penetration, dissipation, and resistivity data are used to determine site stratigraphy.

The cone penetrometer can be a very effective tool for collecting large quantities of subsurface information in a short period of time with virtually no waste generation. A cone penetrometer also can be used for installation of ground-water monitoring points, and specially equipped penetrometers can be used to screen for mobile and residual fuel hydrocarbon contamination using laser induced fluorescence (LIF). Although the equipment is fairly expensive, the overall efficiency can make this option relatively inexpensive.

Most of the disadvantages of CPT are linked to the advantages. For instance, the speed and minimal waste associated with CPT are directly related to the process of determining lithology in situ; however, this does not allow for visual description of subsurface materials. Isolated soil samples can be retrieved for visual description to calibrate the cone penetrometry log, but the procedure cannot be performed frequently (nor continuously) without impairing the efficiency of the penetrometer. And while CPT can be very effective at precisely determining changes in lithology on the basis of grain size, the lack of a visual description prevents stratigraphic correlation on the basis of other parameters, such as color. The U.S. DoD supports a technology development program for site characterization using cone penetrometers (the SCAPS program). SCAPS has developed a down-hole CCD camera and light source that can visualize subsurface sediments.

Monitoring points installed using a cone penetrometer illustrate another advantage that comes with disadvantages. CPT allows for rapid placement of discreet ground-water sampling points at a precise depth selected on the basis of real-time, detailed, stratigraphic logs. The most effective emplacement technique allows for installation of monitoring points of not greater than approximately 0.5 inch ID. While these points may not require much development or purging, ground-water extraction for development, purging, and sampling becomes extremely inefficient if the depth to ground

water is greater than approximately 25 feet. In addition, the monitoring point emplacement technique typically does not allow for installation of a sand pack, bentonite seal, and grout slurry as may be required by regulations.

A.2.3 HYDRAULIC PERCUSSION SYSTEMS

A variety of sampling tools can be advanced through unconsolidated soils using relatively inexpensive hydraulically powered percussion/probing machines (e.g., Geoprobe®). These sorts of systems are frequently mounted on pickup trucks or all-terrain vehicles and, as a result of their small size and versatility, can access many locations that larger equipment cannot.

Hydraulic percussion systems provide for the rapid collection of soil, soil gas, and ground-water samples at shallow depths while minimizing the generation of investigation-derived waste materials. Specifically undisturbed, continuous soils samples can rapidly be collected for visual observation, field analysis, and/or laboratory analysis. In addition, ground-water samples can be collected through the probe rods, or ground-water monitoring points can be installed for later sample collection. Although monitoring points installed by hydraulic percussion systems can vary considerably in design and can include sandpicks and seals, monitoring points are typically narrow in diameter. As a result, it can be difficult to sample points where the ground-water elevation is greater than 25 feet bgs. Furthermore, the narrow diameter may not comply with regulatory standards or future use needs.

SECTION A-3

SOIL CHARACTERIZATION METHODOLOGIES

As part of an evaluation of monitored natural attenuation for contaminants in ground water, soil characterization factors into development of a site conceptual model, estimation of continuing source strength, and modeling of fate and transport. The following sections describe soil sample acquisition, description, field screening, and laboratory analysis procedures. Samples should be collected in accordance with local, State, and Federal requirements.

A.3.1 SAMPLE ACQUISITION

Soil samples can be collected using a variety of methods, depending upon the method used to advance boreholes. In all cases, the goal is to collect samples to allow lithologic logging and to provide useable samples for field screening and for submission to an analytical laboratory. The samples should meet the appropriate data quality objectives as identified in the site-specific Quality Assurance Plan.

When using hollow-stem auger or chain tool methods, relatively undisturbed continuous soil samples can be collected with split-barrel samplers that are either advanced using a hydraulic hammer or are driven along with the advancing auger. These are well-tested methods that are useful in most types of soils except for saturated sands, in which samples tend to liquify and slide out of the barrel. Collection of continuous samples allows a more thorough description of site geology, with only a slight increase in the time required for drilling. These methods also can be used to collect samples in various types of liners, such as acetate or brass sleeves. These sleeves can be cut, capped, and shipped with a minimum of effort. When using sleeves, the samples are disturbed less, but description of the soils may be hindered if the liners are not clear. Other traditional drilling methods (i.e., rotary) do not produce samples that can be used for chemical analysis, and will also make geologic interpretation more difficult due to the disturbed nature of the material.

If CPT or hydraulic percussion methods are used, soil sampled can be collected using a hydraulically driven sampler. When soil samples are collected using a probe-drive sampler, the probe-drive sampler serves as both the driving point and the sample collection device and is attached to the leading end of the driving rods. To collect a soil sample, the sampler is pushed or driven to the desired sampling depth, the drive point is retracted to open the sampling barrel, and the sampler is subsequently pushed into the undisturbed soils. The soil cores are retained within brass, stainless steel, or clear acetate liners inside the sampling barrel. The probe rods are then retracted, bringing the sampling device to the surface. The soil sample can then be extruded from the liners for lithologic logging, or the liners can be capped and undisturbed samples submitted to the analytical laboratory for testing.

If a hand auger is used, samples will be slightly disturbed, but still useful for logging purposes. Removing soil from the auger bucket may prove difficult where soils are clayey. Below the water table, it may be impossible to retain sandy soils in the bucket. Hand driven samplers are similar to probe-drive samplers, except that all pushing power is provided manually.

Following sample acquisition, the coordinates and elevation of all soil sampling locations should be surveyed. Horizontal coordinates should be measured to the nearest 0.1 foot relative to an established coordinate system, such as state planar. The elevation of the ground surface also should be measured to the nearest 0.1 foot relative to USGS mean sea level (msl) data.

A.3.2 PHYSICAL DESCRIPTION

Physical characterization of soils should be performed at all sampling locations and a descriptive log prepared for the materials encountered. If using CPT, the descriptive logs should consist of continuous computer-generated interpretations supplemented by periodic sensory confirmation and

description. Otherwise, continuous sampling with interpretation and description is recommended in order to precisely identify and isolate changes in lithology. The descriptive log should contain:

- Sample interval (top and bottom depth);
- Sample recovery;
- Presence or absence of contamination;
- Lithologic description, including relative density, color, major textural constituents, minor constituents, porosity, relative moisture content, plasticity of fines, cohesiveness, grain size, structure or stratification, relative permeability, and any other significant observations; and
- Depths of lithologic contacts and/or significant textural changes measured and recorded to the nearest 0.1 foot.

In addition, representative samples should be photographed, labeled, and stored. Additional site characterization features are frequently being added to the list of desirable parameters. Static pore pressure and transient pore pressures during penetration with a cone penetrometer are examples.

A.3.3 FIXED-BASE LABORATORY ANALYSES

Portions of selected samples should be sent to the fixed-base laboratory for analysis. It is desirable to sample and submit a relatively undisturbed sample, if possible. Undisturbed samples are typically collected in brass, stainless steel, or clear acetate liners inside of a sampling barrel. Upon removal from the barrel, liners are cut to length (if desired) and capped. If the selected drilling technique, site conditions, or project requirements do not permit collection of undisturbed soils, samples for analysis of volatile constituents should be transferred immediately to an appropriate container in such a way as to minimize volatilization during the transfer and headspace in the sample container. The analytical protocol to be used for soil sample analysis is presented in Table 2.1. This analytical protocol includes the parameters necessary to document the effects of sorption and to estimate the magnitude of the continuing source. The protocol document describes each soil analytical parameter and the use of each analyte in the demonstration of remediation by monitored natural attenuation.

Each laboratory soil sample will be placed in an analyte-appropriate sample container and delivered as soon as possible to the analytical laboratory for analysis of total hydrocarbons, aromatic hydrocarbons, VOCs, and moisture content using the procedures presented in Table 2.1. In addition, at least two samples from locations upgradient, crossgradient, or far downgradient of the contaminant source will be analyzed for TOC, and the chemical and geochemical parameters necessary to characterize the processes and rates of reaction occurring within the plume.

SECTION A-4

GROUND-WATER CHARACTERIZATION METHODOLOGIES

This section describes the scope of work required to collect ground-water quality samples and to perform field analyses to evaluate the demonstration of remediation by monitored natural attenuation. Ground-water sampling should be conducted only by qualified scientists and technicians trained in the conduct of well sampling, sampling documentation, and chain-of-custody procedures. In addition, sampling personnel should thoroughly review this protocol document and the site-specific work plan and quality assurance plan prior to sample acquisition and have a copy of the work plan and quality assurance plan available onsite for reference. Samples should be collected in accordance with local, State, and Federal requirements.

A.4.1 GROUND-WATER MONITORING LOCATIONS, DEPTHS, AND SCREENED INTERVALS

Ground-water monitoring locations should be selected on the basis of the preliminary conceptual site model and information on the three-dimensional distribution of contaminants. At a minimum, one monitoring location should be placed upgradient from the contaminant plume, one location should be placed in the suspected source area, two locations should be placed within the plume, and three locations should be placed various distances downgradient and crossgradient from the plume. The actual number of monitoring locations could be considerably higher and should be related to site conditions and the size of the source.

It is necessary to collect samples that document the vertical extent of contamination at several or at all of the ground-water monitoring locations. This decision is based on the presence of confining units, the thickness of the aquifer, the type and source of contamination, and suspected variations in subsurface transmissivity. The position of well screens should be selected by the field scientist after consideration is given to the geometry and hydraulic characteristics of the stratum in which the well will be screened. Wells should be screened so that the vertical distribution of contaminants and hydraulic gradients can be delineated. Typically the shallowest ground-water monitoring depth is chosen to intersect the water table. This allows for the monitoring of LNAPL and seasonal water level fluctuations, as well as dissolved contaminant concentrations in the portion of the aquifer closest to the typical source. Deeper locations are selected on the basis of contaminant distribution, typically above or below suspected confining units or in zones believed to possess higher transmissivity. To ensure well integrity, clustered monitoring wells/monitoring points generally should be completed in separate boreholes.

Screen lengths of not more than 5 feet are recommended to help mitigate the dilution of water samples from potential vertical mixing of contaminated and uncontaminated ground water. Screening a larger area of the saturated zone will result in averaging of contaminant concentrations and hydraulic properties. In addition, short screened intervals used in nested pairs give important information on the nature of vertical hydraulic gradients in the area.

A.4.2 TYPES OF GROUND-WATER SAMPLING LOCATIONS

Ground-water samples for the demonstration of remediation by monitored natural attenuation can be collected from monitoring wells, monitoring points, or grab sampling locations. Monitoring points and grab locations provide rapid and inexpensive access to shallow ground-water, and yield ground-water samples that are appropriate for site characterization and plume definition. Conventional monitoring wells are required for sites with ground-water elevations more than approximately 25 feet below ground surface. They also are recommended for long-term monitoring (LTM) and performance evaluation ground-water sampling, and may be required for regulatory compliance.

Following installation, the location and elevation of all ground-water monitoring locations should be surveyed. Horizontal coordinates should be measured to the nearest 0.1 foot relative to an

established coordinate system, such as state planar. The elevation of the ground surface also should be measured to the nearest 0.1 foot relative to USGS mean sea level (msl) data. Other elevations, including the measuring point, should be measured to the nearest 0.01 foot.

A.4.2.1 Monitoring Wells

Monitoring wells are commonly installed to evaluate remediation by monitored natural attenuation. As used in this document, monitoring wells are assumed to have, at a minimum, a sand pack, a bentonite seal, an annular seal, a surface seal, and an inside diameter of at least 2 inches. Monitoring wells are extremely versatile and can be used for ground-water sampling, aquifer testing, product recovery systems, long-term monitoring, and performance evaluation monitoring. Although versatile, monitoring wells are relatively expensive to install and create relatively large quantities of waste during installation, development, and sampling. Detailed well installation procedures are described in the following paragraphs. Of course, local protocols, regulations, type of drill rig, site conditions and site-specific data uses should dictate actual well completion details.

The monitoring well should be installed in a bore hole with a diameter at least 4 inches larger than the outside diameter of the well. At a minimum, blank well casing and screen should be constructed of Schedule 40 polyvinyl chloride (PVC) with an inside diameter (ID) of 2 inches. Frequently, this diameter must be increased if the well may be used for a pumping test or certain types of product or ground-water recovery. The screens should be factory slotted with appropriately sized openings (typically 0.010-inch). All well sections should be flush-threaded; glued joints should not be used. The casing at each well should be fitted with a threaded bottom plug and a top cap constructed of the same type of material as the well casing. The top should be vented to maintain ambient atmospheric pressure within the well casing. It is possible that PVC will not be suitable for use in wells intended to monitor high concentrations of volatile organic constituents.

Once the well is in place, sand, bentonite, and grout are used to fill the remaining borehole annulus. Appropriately-sized sand must be packed along the entire length of the screen; however, it is desirable to limit the vertical distance that the sand pack extends to either side of the screen (i.e., at least 6 inches but less than 2 feet) because the added sand pack can increase the portion of the aquifer that is effectively screened. A bentonite seal is placed on top of the sand pack. If conditions permit, this seal should have a minimum thickness of 2 feet. A cement-bentonite grout is used to fill the remainder of the annular space between the bentonite seal and the surface completion. Depending on site conditions and facility preferences, either flush-mount or stick-up surface completions can be used. Site conditions and local, State, and Federal requirements should ultimately dictate materials selection and construction details.

The field scientist should verify and record the boring depth, the lengths of all casing and screen sections, and the depth to the top of all well completion materials placed in the annulus between the casing and borehole wall. All lengths and depths should be measured to the nearest 0.1 foot.

A.4.2.2 Monitoring Points

Where site conditions and the regulatory environment permit, monitoring points are ideal tools for rapidly and cost-effectively obtaining site data to evaluate a remediation by monitored natural attenuation. Monitoring points can be installed and sampled rapidly while generating a minimal volume of waste. Furthermore, some monitoring points cannot be used for ground-water or free product level measurements. It is always useful when a site has a reasonable and adequate number of monitoring wells. Detailed monitoring point installation procedures are described in the following paragraphs. Of course, local protocols, regulations, available equipment, and site conditions should dictate actual well completion details.

In this document, monitoring points are considered temporary or permanent ground-water sampling locations that do not meet the specifications of monitoring wells. Typically monitoring

points are installed in small diameter boreholes using CPT, hydraulic percussion, or manually-powered equipment. As a result, monitoring points usually have an ID of less than 2 inches. In addition, because of the extremely small to nonexistent annular space between the borehole wall and the monitoring point materials, they seldom have a sand pack, bentonite seal, and grout seal, particularly with an annulus of 2 inches. Because these components are missing, ground-water monitoring points should be installed only in shallow aquifers where installation of such devices will not result in the cross-contamination of adjacent water-bearing strata.

Like monitoring wells, monitoring points are typically constructed of Schedule 40 PVC casing and screen; however, monitoring points also can be constructed from Teflon[®]-lined tubing attached to a stainless steel, wire mesh screen. Because the screens are often installed without a sand pack, a slot size of 0.010 inch or smaller should be used. All monitoring point casing and screen sections should be flush-threaded; glued joints should not be used. The casing at each monitoring point should be fitted with a bottom cap and a top cap constructed of PVC. The top cap should be vented to maintain ambient atmospheric pressure within the monitoring point casing. Site conditions and local, State, and Federal requirements should ultimately dictate materials selection and construction details.

The field hydrogeologist should verify and record the total depth of the monitoring point, the lengths of all casing and screen sections, and the depth to the top of all monitoring point completion materials. All lengths and depths should be measured to the nearest 0.1 foot.

A.4.2.3 Grab Sampling

Ground-water grab samples are temporally and spatially discrete samples collected from boreholes that are abandoned upon completion of sampling. In highly transmissive aquifers, the collection of grab samples can provide a rapid, cost-effective alternative to the use of monitoring points. Like monitoring points, collection of grab samples generates minimal waste; however, they are not appropriate for aquifer testing, remediation systems, or long-term monitoring. Furthermore, because the locations are abandoned upon completion of sampling, analytical results cannot be confirmed, and ground-water levels at all locations cannot be collected over the space of a few hours for use in the development of ground-water flow maps. In addition, if the aquifer is not particularly transmissive, sample collection can require hours resulting in inefficient equipment utilization. For these reasons, installation and sampling of monitoring points typically is recommended where feasible. Several of the more common instruments used to collect ground-water grab samples include the HydroPunch[®], Geoprobe[®], cone penetrometer, or hand-driven points. An optimal site characterization approach often involves use of grab samples acquired by push technologies such as the HydroPunch[®], Geoprobe[®], cone penetrometer, or hand-driven points for a rapid, three-dimensional characterization of the site, then using that information to select locations and screened intervals for permanent monitoring points.

A.4.3 MEASUREMENT OF STATIC FLUID LEVELS

A.4.3.1 Water Level and Total Depth Measurements

Prior to purging or developing any water from a ground-water sampling location, the static water level should be measured. At all locations of sufficient diameter, an electric water level probe should be used to measure the depth to ground water below the datum to the nearest 0.01 foot. Small diameter probes are commercially available for measurement of water levels in monitoring points and through Geoprobe[®], HydroPunch[®], and CPT pushrods. After measuring the static water level, the water level probe should be slowly lowered to the bottom of the well, and the total well depth should be measured to the nearest 0.01 foot. If measuring from the ground surface, an accuracy better than 0.1 foot is probably not practical. Based on these measurements the volume of water to be developed or purged from the location can be calculated. If mobile LNAPL is encountered, the

LNAPL thickness should be determined, and attempts should be made to sample both the ground water below the LNAPL layer as well as the LNAPL.

If a sufficiently narrow water level probe is unavailable, hollow, high-density polyethylene (HDPE) tubing connected to a manometer can be used to determine depth to ground water. The manometer will indicate when ground water is reached as the HDPE tubing is inserted into the monitoring location. The HDPE attached to the manometer will then be marked at the level of the ground surface and removed. The depth to water will be determined by placing a tape measure next to the HDPE tubing and measuring the length from the base of the tubing to the ground level mark to the nearest 0.01 foot, if possible.

A.4.3.2 Mobile LNAPL Thickness Measurements

At sites where phase-separated hydrocarbons are present in the ground-water system, it is important to accurately measure the thickness of floating hydrocarbons. Accurate measurement of hydrocarbon thickness allows for estimation of the amount and distribution of the hydrocarbon and correction of measured ground-water elevations. There are three methods that can be used to determine the thickness of mobile LNAPL in a well, including use of an interface probe, a bailer, or tape and paste. Interface probes generally operate on either light refraction sensors or density float switches to detect hydrocarbons and the hydrocarbon/water interface. The depth to mobile LNAPL and depth to water should be measured to the nearest 0.01 foot. The thickness of phase-separated hydrocarbons should also be measured to the nearest 0.01 foot. Three consecutive measurements should be made to ensure the accuracy of the measuring instrument. A clear bailer can be slowly lowered into the well until it intersects the fluid but is not totally immersed. The bailer is then retrieved, and the floating LNAPL can be visually observed and measured with an engineer's tape. The third method for measurement of floating hydrocarbon thickness is hydrocarbon paste and an engineer's tape. The paste, when applied to the tape, changes color when it intersects the hydrocarbon and the hydrocarbon/water interface. Measurements of the mobile LNAPL thickness can be made directly from the engineer's tape. It is extremely important to remember to thoroughly decontaminate all equipment between well measurement events to prevent cross-contamination of wells. Equipment blanks, part of the Quality Assurance Program, will confirm the suitability of the decontamination activities.

Measurements of mobile LNAPL thickness made in monitoring wells provide only an estimate of the actual thickness of NAPL at that location. Actual mobile and residual LNAPL thicknesses can only be obtained from continuous soil cores. Correcting apparent mobile LNAPL thickness as measured in monitoring wells to true thickness is discussed in Appendix C.

A.4.3.3 Mobile DNAPL Thickness Measurements

DNAPL thickness in wells cannot be used to estimate actual DNAPL quantities on a site.

A.4.3 GROUND-WATER EXTRACTION

Varied equipment and methods are available for the extraction of ground water. The approach is determined on the basis of application (development, purging, or sampling), hydrogeologic conditions, monitoring location dimensions, and regulatory requirements.

Ground water produced during extraction activities must be handled in a manner consistent with the investigation-derived waste (IDW) plan for the site. The method of handling and disposal will depend on location and type of source, site contaminants, degree of contamination (e.g., free product, odor, air monitoring measurements), and applicable local, State, and Federal regulations.

A.4.3.1 Methods

Portable ground-water extraction devices from three generic classifications are commonly used for investigations of monitored natural attenuation: grab, suction lift, and positive displacement.

The selection of the type of device(s) for the investigation is based on type of activity, well/point dimensions, and hydrogeologic conditions.

Bailers are common grab sampling devices. Disposable bailers can be used to avoid decontamination expenses and potential cross-contamination problems. Drawbacks for bailers include agitation/aeration of the ground water and the inability to maintain a steady, non-turbulent flow required to establish a true flow-through cell. Aeration also can be an issue during transfer of the sample from the bailer to the sample container. As a result of aeration, and because a true flow-through cell cannot be established, accurate dissolved oxygen and ORP measurements can be difficult to obtain.

The suction lift technology is best represented in environmental investigations by the peristaltic pump. A peristaltic pump extracts water using a vacuum created by cyclically advancing a sealed compression along flexible tubing. This pumping technique means that extracted water contacts nothing other than tubing that can be easily replaced between sampling locations. This reduces the possibility of cross-contamination. Furthermore, peristaltic pumps can be used to extract minimally-disturbed ground water from any size monitoring location at variable low-flow rates. Because of these features, representative samples are simple to collect, and reliable flow-through cells are simple to establish. The biggest drawback with a peristaltic pump is the maximum achievable pumping depth which is equivalent to the height of water column that can be supported by a perfect vacuum. This effectively limits the use of a peristaltic pump to monitoring locations with groundwater depths of less than approximately 25 feet. Also, off-gasing can occur in the tubing as a result of the reduced pressures and high-rate of cyclical loading. If bubbles are observed in the tubing during purging or sampling, the flow rate of the peristaltic pump must be slowed. If bubbles are still apparent, the tubing should be checked for holes and replaced. The final potential disadvantage with a peristaltic pump is the low flow rate. Although advantageous for sampling, this can be inappropriate during purging or development at locations with large extraction volumes. Puls and Barcelona (1996) show that the use of peristaltic pumps does not compromise sample integrity as long as no bubbles form during sampling. If the ground water is saturated with methane or carbon dioxide, it is practically impossible to collect samples without a gas headspace. Pankow (1986) gives advice on how to correct for this problem.

Positive displacement pumps, also called submersible pumps, include, for example, bladder pumps, Keck[®], Grundfos Redi-Flo II[®], Bennett[®] and Enviro-Tech Purger ES[®] pumps. Each of these pumps operates downhole at depths of up to a few hundred feet and rates of up to several gallons per minute. Therefore, submersible pumps are particularly useful for applications requiring the extraction of large volumes of water or for the extraction of ground water from depths in excess of 25 feet. Because the pumps operate downhole, they require appropriately-sized wells. At a minimum, an inside well diameter of at least 1.5 inches typically is required; however, much larger well diameters can be required depending on the selected pump type, extraction depth, and extraction rate. Because typical submersible pump design results in contact between the ground water and internal as well as external surfaces of the pump, rigorous decontamination and quality assurance procedures must be implemented to avoid cross-contamination if a pump that is not dedicated to the well is used for sampling.

A.4.3.2 Development

Monitoring wells and points should be developed prior to sampling to remove fine sediments from the portion of the formation adjacent to the screen. Development is not required for grab sampling locations. Because development is intended to enhance ground-water production and quality through the removal of fine sediments in the immediate vicinity of the screen, high flow rates and downhole turbulence are beneficial. This is particularly true for monitoring wells because of the formation disturbance usually associated with installation. Development can be accomplished using

any of the methods discussed in Section A.4.3.1 with selection dependent on well/point dimensions, well/point installation procedures, and hydrogeologic conditions.

Development is accomplished through the removal of water from the well/point in combination with screen/sand pack cleansing through agitation of the downhole ground water. The “agitation” is typically provided by pumping at a high flow rate; surging with the pump, a surge block, or a bailer; and/or pumping along the entire length of the screen. As a rule, the more “agitation” that can be provided, the “better” the development. Typically during development, ground water is extracted until dissolved oxygen, pH, temperature, specific conductivity, and water clarity (turbidity) stabilize. Monitoring well/point development should occur a minimum of 24 hours prior to sampling. Development water must be handled in accordance with the site IDW plan.

It is important to maintain a record of development for each location. The development record should include the following information, at a minimum:

- Monitoring point/well number;
- Date and time of development;
- Development method;
- Monitoring point/well depth;
- Volume of water produced;
- Description of water produced;
- Post-development water level and monitoring point/well depth; and
- Field analytical measurements, including pH, temperature, and specific conductivity.

A.4.3.3 Purging

Purging consists of the evacuation of water from the monitoring location prior to sampling, so that “fresh” formation water will enter the monitoring location and be available for sampling. Because sampling can occur immediately upon completion of purging, it is best to limit ground-water agitation, and consequently, aeration of the ground water and volatilization of contaminants. Two sources for agitation include the purging device and the cascading of water down the screen as the water level in the well drops. To avoid agitation, a low-disturbance device such as a peristaltic pump or bladder pump is recommended for purging, while equipment such as bailers should be avoided. To avoid aeration, wells or points that were initially screened below the water table should be pumped at a rate which prevents lowering of the water table to below the top of the screen, and if practical, wells or points screened across the water table should be pumped at a rate that lowers the total height of the water column no more than 10 percent of the screened interval. Purging should follow the recommendations of Puls and Barcelona (1996).

Typically, the volume of water contained within the monitoring well/point casing is used to estimate the amount of ground water that should be removed during the purge. As a general rule, three times the calculated volume should be removed from the well/monitoring point; however, this can be reduced to between 1 and 3 volumes for low-producing wells and wells with a very large water column, but a very short screened interval. Purging should continue until parameters such as pH, temperature, specific conductance, dissolved oxygen, and ORP stabilize. Sampling should occur as soon after purging as practical, and definitely within 24 hours. Purge waters must be handled in accordance with the site IDW plan.

If a monitoring well/monitoring point is evacuated to a dry state during purging, the monitoring well/monitoring point should be allowed to recharge, and the sample should be collected as soon as sufficient water is present in the monitoring well or monitoring point to obtain the necessary sample quantity. Sample compositing or sampling over a lengthy period by accumulating small volumes of water at different times to obtain a sample of sufficient volume should be avoided.

It is important to record purge information as a part of the sampling record for each location. At a minimum, the following information pertaining to the purge should be recorded:

- Monitoring point/well number;
- Date and time of purge;
- Purge method;
- Monitoring point/well depth;
- Volume of water produced;
- Description of water produced;
- Post-purge water level; and
- Field analytical measurements, including pH, temperature, specific conductivity, dissolved oxygen concentration, and ORP;
- Thickness of LNAPL, if present, in the point/well prior to purging;
- Volume of LNAPL removed during purging.

A.4.3.4 Sampling

Sampling should occur immediately after purging. If well yield is less than 1/10 of a liter per minute, sample according to the guidance provided by Puls and Barcelona (1996). The object of sampling is the collection of representative ground-water samples. This means that impact to the sample as a result of turbulence, contact with equipment, or a change in conditions must be minimized. The use of a peristaltic pump with dedicated HDPE tubing is recommended for monitoring locations where the depth to water is less than 25 feet because the peristaltic pump is capable of providing a steady, low-flow, stream of ground water which has contacted only dedicated tubing. In addition, conditions are relatively unchanged, so long as care is taken to ensure that the pumping suction does not cause the ground water to boil as a result of the reduced pressure. Where the depth to ground water is greater than 25 feet, a dedicated positive displacement pump, when available, is best. Because of the decontamination difficulties and the resulting potential for cross-contamination associated with most positive displacement pumps, sampling through these pumps is not recommended unless the pumps are dedicated. A bailer should be used only if it is the only means of obtaining a sample.

An overflow cell, such as the one pictured on Figure A.4.1, or a flow-through cell as pictured in Figure A.4.2, should be used for the measurement of well-head parameters, including pH, temperature, specific conductance, dissolved oxygen, and ORP. When using a pump to purge or sample, the pump intake tubing should be positioned near the bottom of the cell. If using a bailer, the water should be drained from the bottom of the bailer through tubing into the cell. In either case, the tubing should be immersed alongside the dissolved oxygen probe beneath the water level in the cell. This will minimize aeration and keep water flowing past the dissolved oxygen probe's sampling membrane. The probes for the other parameters are less sensitive to positioning within the flow-through cell.

Samples should be collected directly from the pump discharge tube or bailer into a sample container of appropriate size, style, and preservation for the desired analysis. Water should be directed down the inner walls of the sample bottle to minimize aeration of the sample. All samples to be analyzed for volatile constituents (e.g., SW8010, SW8020, SW8240, SW8260, and TPH-g) or dissolved gases (e.g., methane, ethane, and ethene) must be filled and sealed so that no air space remains in the container. Sample handling procedures are further described in Section A.6.

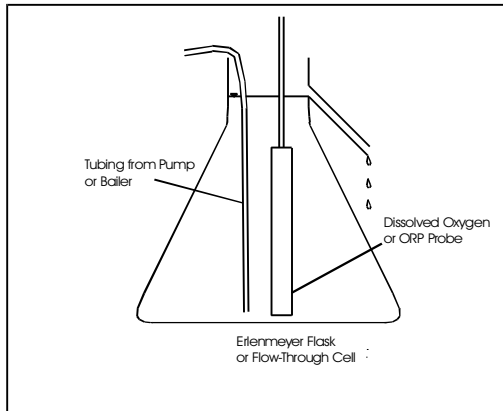

Figure A.4.1 *Overflow cell to prevent alteration of geochemical properties of ground water by exposure to the atmosphere.*

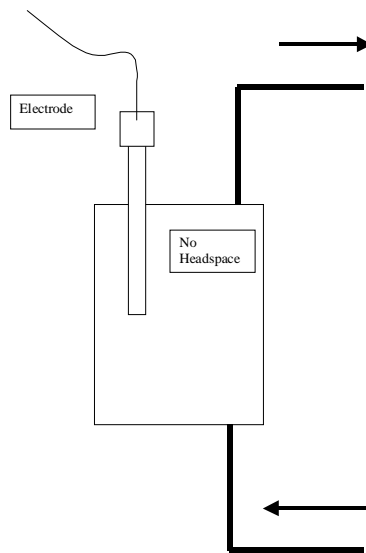

Figure A.4.2. *Flow-through cell to prevent alteration of geochemical properties of ground water by exposure to the atmosphere.*

A.4.4 GROUND-WATER ANALYTICAL PROCEDURES

In order to demonstrate the efficacy of monitored natural attenuation, field and laboratory analyses should be performed on all ground-water samples using the analytical procedures listed in Table 2.1. As a result of analyte properties and available detection equipment, analyses can be performed at the sampling location, a portable field laboratory, or a fixed-base laboratory. The dissolved hydrogen analysis is unique in that it requires a combination of well-head and field laboratory procedures that are somewhat different from other field methods; therefore, it is presented in a separate subsection. Several of the analytes or parameters can be measured in more than one manner; consequently, the methods provided in this section should not be considered absolute. Rather, these methods have been proven to provide reliable information. The site-specific data quality needs

of each project will be determined during the Data Quality Objective Process and documented in the Quality Assurance Plan.

In order to obtain accurate and defensible data, it is critical that quality assurance procedures are followed for all analyses. These procedures generally fall into the following categories:

- Collection and handling of samples;
- Calibration of direct read meters, chromatographs, colorimeters, and field instruments per manufacturer's instructions;
- Decontamination of equipment and containers; and
- Confirmation of results through analysis of blanks, duplicates, and other quality control samples.

Actual procedures are equipment and analysis specific, and must be developed accordingly.

A.4.4.1 Standard Well-Head Analyses

Standard well-head analyses include pH, conductivity, temperature, dissolved oxygen, and ORP because these parameters can be measured with a direct-reading meter. This allows all of these parameters to be used as indicators for ground-water stability during development and purging activities. In addition, dissolved oxygen and ORP can be used to provide real time data on the location of the contaminant plume, especially in areas undergoing anaerobic biodegradation. Temperature, dissolved oxygen, and ORP must be measured at the well head in unfiltered, unpreserved, "fresh" water because these parameters can change significantly within a short time following sample acquisition. Section 2.3.2 of the protocol document describes each analysis and its use in the demonstration of monitored natural attenuation.

It is critical that samples collected for well-head analyses are disturbed and aerated as little as possible; therefore, the use of a flow-through cell, as described in Section A.4.3 and illustrated on Figure A.4.1, is recommended. Where this is not possible, measurements can be made in a clean glass container separate from those intended for laboratory analysis. Where ground-water extraction disturbs the sample, downhole probes can be used for dissolved oxygen analyses, but such probes must be thoroughly decontaminated between wells. In some cases, decontamination procedures can be harmful to the dissolved oxygen probe, and inadequate decontamination can create potential cross-contamination problems if performed prior to sample collection for the other analytes. After sample acquisition, the downhole ground water may be too disturbed to collect an accurate downhole DO measurement.

A.4.4.2 Dissolved Hydrogen Analysis

As described in Section 2.3.2.9, dissolved hydrogen (H_2) concentrations can be an indicator of microbially mediated redox processes in ground-water systems. Determination of H_2 concentrations is a two-step process in the field: sampling at the well head and analysis with a reducing gas detector.

Hydrogen is highly volatile, and this chemical property can be used to measure H_2 concentrations in ground water. The principle is to continuously pump ground water through a gas-sampling bulb containing a nitrogen or air "bubble" so that the H_2 can partition between the gas and liquid phases until the concentration of H_2 in the bubble comes into equilibrium with concentration of H_2 in the ground water. The bubble is then analyzed for H_2 and the concentration of H_2 in the ground water is calculated using the Ideal Gas Law and Henry's Law. This method is referred to as the "bubble strip" method (Chapelle et al., 1995,1997), because the bubble "strips" H_2 out of the water.

A.4.4.2.1 Sampling Method

The following procedures are recommended for the collection of a sample for analysis by the "bubble strip" method:

1. Place the intake hose of a peristaltic pump, a Bennett positive displacement pump, or a bladder pump into the sampling well at the depth of the screened interval.

Do not sample for H₂ with electrical submersible pumps because they may produce hydrogen. Do not sample for H₂ from wells with metal screens or casings because they may produce hydrogen and interfere with measurements.

2. Attach a glass, 250-ml gas-sampling bulb (Figure A.4.3) to the outflow end of the tube.
 3. Turn on the pump and adjust the flow rate to between 400 and 700 mL/min.
 4. Briefly hold the outlet end of the sampling bulb in the upright position to remove any gas bubbles from the bulb.
 5. Place the bulb in a horizontal position and inject 20 mL of hydrogen-free N₂ gas through the septum (Figure A.4.3).
 6. Allow the N₂ bubble to come into equilibrium with the flowing ground water for 30 minutes. This equilibration process takes approximately 20 minutes.
 7. Remove 3-5 mL of the gas bubble using a 10 mL glass syringe with attached mini-inert valve.
 8. Close the valve to seal the sample.
 9. Wait an additional 5 minutes and repeat steps 7 and 8.
 10. Analyze both samples on the hydrogen detector, as described in Section A.4.4.2.2.
- Resample the well if the H₂ concentrations of the duplicate samples do not agree within 10 percent.

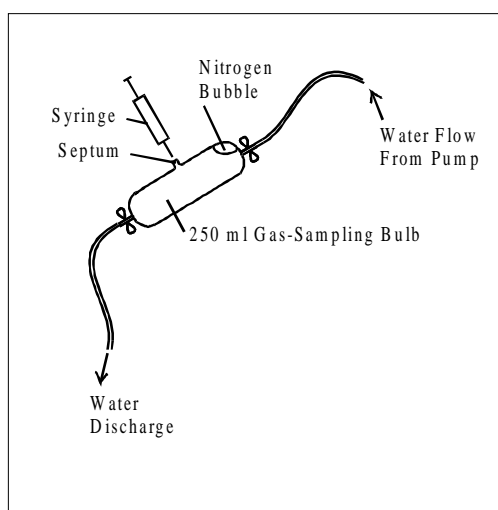

Figure A.4.3 Schematic showing the “bubble strip” method for measuring dissolved hydrogen concentrations in ground water.

A.4.4.2.2 Analytical Method

Concentrations of H₂ in the nitrogen bubble are determined by gas chromatography (GC) with reduction gas detection (Trace Analytical, Menlo Park, CA). To perform this analysis, a gaseous sample is injected into the stream of a carrier gas such as N₂. The sample is transported by the carrier through a separation column where the components of the sample are separated on the basis of variations in their transport efficiency through the column matrix. The column is packed with CarboSieve II which separates chemical species primarily on the basis of molecular size. The separated components elute from the column and pass through a heated bed of HgO where the reduced gases (primarily H₂ and CO) are oxidized and Hg vapor is released. The concentration of Hg vapor released is directly proportional to the concentration of reduced gases present in the sample and is

detected by means of an ultraviolet photometer. Because chlorinated solvents can destroy the HgO bed, the column is backflushed immediately after the H₂ peak is quantified.

The concentration of H₂ dissolved in the ground water can be calculated from the equilibrated concentration in the nitrogen gas bubble as follows:

- 1) Prepare a calibration curve for H₂ using a 100 ppm Scotty II standard gas mixture. The calibration curve should range from 0.1 to 10.0 μL/L (ppm).
- 2) Analyze the gas sample taken from the gas-sampling bulb, obtaining results (C_B) in units of μL/L (ppm) in the gas phase.
- 3) Calculate the aqueous concentration of H₂ (C_w in nanomoles per liter (nM)) in equilibrium with the equilibrated bubble gas (C_B, μL/L (ppm)) sample using the conversion factor:

$$C_w = 0.81C_B \quad \text{eq. A.4.1}$$

This conversion factor is derived from the Ideal Gas Law and Henry's Law as follows:

$$PV = nRT \quad (\text{Ideal Gas Law}) \quad \text{eq. A.4.2}$$

Rearrange to give:

$$\frac{n}{V} = \frac{P}{RT} \quad \text{eq. A.4.3}$$

Where:

n = the quantity of gas in moles

V = the volume the gas occupies in Liters

P = the partial pressure of the gas in atm

T = the temperature in °K

R = the gas constant (R = 0.08205 atm L mole⁻¹ °K⁻¹)

Thus the concentration of a pure gas at atmospheric pressure and room temperature is 40.9mmoles/L.

For a 1.0 ppm calibration standard (i.e., 1.0 μL/L), the H₂ concentration in molar units would be:

$$(40.9 \text{mmoles} / L_{H_2})(10^{-6} L_{H_2} / L_{gas})(10^6 \text{nmoles} / \text{mmoles}) = 40.9 \text{nmoles} / L_{gas} \quad \text{eq. A.4.4}$$

The dissolved H₂ concentration in the aqueous phase is given by Henry's Law:

$$C_w = \frac{C_h}{H_{H_2}} \quad \text{eq. A.4.5}$$

$$\text{Conversion factor} = \frac{(40.9 \text{nmoles} L^{-1} \text{ppm}^{-1})}{50.4} = 0.81 \quad \text{eq. A.4.6}$$

Where:

C_w = the dissolved H₂ concentration in nmoles/L

C_h = the equilibrated bubble H₂ concentration in nmoles/L

H_{H₂} = the dimensionless Henry's Law coefficient for the distribution of H₂ between the gaseous and dissolved phases (H_{H₂} = 50.4).

- 4) Identify the predominant terminal electron accepting process for the water sample using the characteristic ranges presented in Table 2.5.

A.4.4.3 Field Analytical Laboratory Analyses

The field analytical laboratory analyses to be used for ground-water samples are presented in Table 2.1. These analyses include parameters that are time-sensitive or can be performed accurately, easily, and inexpensively on site. In addition, results obtained from field laboratory analyses provide real-time data on the location of the contaminant plume, especially in areas undergoing anaerobic biodegradation. This real-time data can be used to guide the investigation of monitored natural

attenuation at sites with limited or ambiguous hydrogeologic and plume information. Section 2.3.2 of the protocol document describes each analysis and its use in the demonstration of monitored natural attenuation.

In preparation for field laboratory analysis, all glassware or plasticware used in the analyses must be cleaned thoroughly by washing with a solution of laboratory-grade, phosphate-free detergent (such as Alconox®) and water, and rinsing with deionized water and ethanol to prevent interference or cross-contamination between measurements. If concentrations of an analyte are above the range detectable by the titrimetric method, the analysis should be repeated by diluting the ground-water sample with double-distilled water until the analyte concentration falls to a level within the range of the method. All rinseate and sample reagents accumulated during ground-water analysis must be handled appropriately, including collection, labeling, storage, and disposal.

Carbon dioxide (CO₂) is a byproduct of naturally occurring aerobic and anaerobic biodegradation processes that occur in ground water. Carbon dioxide concentrations in ground water can be measured in the field by titrimetric analysis using CHEMetrics® Method 4500 (0 to 250 mg/L as CO₂), or similar.

An increase in the alkalinity of ground water above background may be produced when carbon dioxide produced by biological activity reacts with carbonate minerals in the aquifer matrix material. Alkalinity of the ground-water sample will be measured in the field by titrimetric analysis using U.S. EPA-approved Hach® Method 8221 (0 to 5,000 mg/L as calcium carbonate), or similar.

Nitrate-nitrogen concentrations are of interest because nitrate can act as an electron acceptor during hydrocarbon biodegradation under anaerobic soil or ground-water conditions. Nitrate-nitrogen is also a potential nitrogen source for hydrocarbon-degrading bacteria biomass formation. Nitrite-nitrogen is an intermediate byproduct in both ammonia nitrification and in nitrate reduction in anaerobic environments. Nitrate- and nitrite-nitrogen concentrations in ground water can be measured in the field by colorimetric analysis using a portable colorimeter (such as the Hach® DR/700). Nitrate concentrations in ground-water samples can be analyzed after preparation with Hach® Method 8039 (0 to 30.0 mg/L nitrate), or similar. Nitrite concentrations in ground-water samples can be analyzed after preparation with U.S. EPA-approved Hach® Method 8507 (0 to 0.35 mg/L nitrite), or similar.

Sulfate in ground water is a potential electron acceptor for fuel-hydrocarbon biodegradation in anaerobic environments, and sulfide is produced by biological sulfate reduction. Sulfate and sulfide concentrations can be measured by colorimetric analysis with a portable colorimeter (such as the Hach® DR/700) after appropriate sample preparation. U.S. EPA-approved Hach® Methods 8051 (0 to 70.0 mg/L sulfate) and 8131 (0.60 mg/L sulfide) (or similar) can be used to prepare samples and analyze sulfate and sulfide concentrations, respectively.

Iron III is an electron acceptor for biological metabolism under anaerobic conditions. Iron III is the substrate for biological iron reduction; Iron II is the product. Iron concentrations can be measured in the field by colorimetric analysis with a portable colorimeter (such as a Hach® DR/700) after appropriate sample preparation. Hach® Method 8008 for total soluble iron (0 to 3.0 mg/L ferric + ferrous iron) and Hach® Method 8146 for ferrous iron (0 to 3.0 mg/L) (or similar) can be used to prepare and quantitate the samples. Ferric iron is quantitated by subtracting ferrous iron levels from total iron levels.

Manganese is a potential electron acceptor under anaerobic environments. Manganese concentrations can be quantitated in the field using colorimetric analysis with a portable colorimeter (such as a Hach® DR/700). U.S. EPA-approved Hach® Method 8034 (0 to 20.0 mg/L), or similar, can be used to prepare the samples for quantitation of manganese concentrations.

A.4.4.4 Fixed-Base Laboratory Analyses

The fixed-base laboratory analyses to be used for ground-water samples are presented in Table 2.1. These analyses include the parameters that cannot be easily or accurately performed in the field, but are necessary to document monitored natural attenuation of fuel hydrocarbons and chlorinated solvents in ground water. Section 2.3.2 of the protocol document describes each analysis and its use in the demonstration of monitored natural attenuation.

Prior to sampling, arrangements should be made with the analytical laboratory (or other supplier) to provide a sufficient number of appropriate sample containers for the samples (including quality control samples) to be collected. All containers, preservatives, and shipping requirements should be consistent with the analytical protocol. For samples requiring chemical preservation, preservatives are best added to containers by the laboratory (or other supplier) prior to shipping. Sample handling is discussed in Section A.6.

SECTION A-5

SURFACE WATER AND SEDIMENT CHARACTERIZATION METHODOLOGIES

At sites where surface water bodies are affected (or potentially affected) by contamination, surface water and sediment sample collection and analysis may be required as a component of the remediation by monitored natural attenuation demonstration.

A.5.1 SURFACE WATER SAMPLE COLLECTION

Surface water can be collected with a peristaltic pump using exactly the same equipment and procedures to collect water from a well. The sampling tube can be introduced into the water from a barge or boat, or from a dock. The depth to the sediment should be sounded, then the tube introduced to a level a very few inches above the sediment layer. A weight can be used to keep the tube straight. Alternately, ½ inch PVC pipe can be inserted to the correct depth, then sampled with a tube just as if it were a well.

Many plumes discharge at some distance away from the shoreline of lakes or large rivers. Samples should be taken at locations where the elevation of the sediment-to-water interface corresponds to the elevation of the contaminant plume in the aquifer. Many plumes are driven down into aquifers by recharge. Conversely, the flow path bends sharply up underneath a gaining stream at the point of discharge. Water just above the sediment in the center of a stream or small river should be sampled. If possible, the stage of a stream or river at a gauging station near the point of sampling should be determined to estimate the discharge of the stream or river at the time of sampling. Losing streams or rivers should not be sampled at high stage when they are losing water because groundwater plumes would be pushed away from the sediment interface. To ensure that the stream is not losing, the elevation of standing water in monitoring wells near the river should be higher than the stage of the river or stream at the time of sampling. The same considerations apply to tidal environments or areas with wind seiches on large bodies of water. Surface water should be sampled when the tide is out, or the wind is blowing off-shore. Additionally, contaminant plumes may be deflected strongly downstream by flow occurring within the saturated material surrounding the surface water channel. This is particularly true when the hydraulic conductivity of the stream sediments is much greater than the hydraulic conductivity of the surrounding material that supplies ground water to the stream. A great deal of thought as to when and where to sample is necessary to yield meaningful results.

A.5.2 SEDIMENT SAMPLE COLLECTION

Sediment samples below the water surface can be collected using a core barrel. The core barrel can be hand driven to the desired depth from a boat, then pulled back up using a mechanical jack after sampling is finished. An alternative technique is to place open-end, two-inch diameter PVC tubing to a desired depth, then insert flexible tubing and collect the sediment as a slurry into a suction flask connected to a peristaltic pump.

SECTION A-6

SAMPLE HANDLING

This section describes the handling of soil and ground-water samples from the time of sampling until the samples arrive at the laboratory.

A.6.1 SAMPLE PRESERVATION, CONTAINERS, AND LABELS

Sample containers and appropriate container lids must be purchased or provided by the analytical laboratory. Any required chemical preservatives can be added to the sample containers by the analytical laboratory prior to shipping the containers to the site or alternatively, at the time of sampling. The sample containers should be filled and tightly sealed in accordance with accepted procedures for the sample matrix and the type of analysis to be conducted. The sample label should be firmly attached to the container side, and the following information legibly and indelibly written on the label:

- Facility name;
- Sample identification;
- Sample type (groundwater, surface water, etc.);
- Sampling date;
- Sampling time;
- Preservatives added; and
- Sample collector's initials.

A.6.2 SAMPLE SHIPMENT

After the samples are sealed and labeled, they should be packaged for transport to the analytical laboratory. The packaged samples should be delivered to the analytical laboratory shortly after sample acquisition using an overnight delivery service. The following packaging and labeling procedures are to be followed:

- Abide by all U.S. Department of Transportation (DOT) shipping regulations;
- Package samples so that they will not leak, spill, or vaporize from their containers;
- Place samples in a cooler containing ice to maintain a shipping temperature of approximately 4 degrees centigrade (°C), if required by the requested analyses;
- Include a properly completed chain-of-custody form, as described in the following subsection; and
- Label shipping container with
 - Sample collector's name, address, and telephone number;
 - Laboratory's name, address, and telephone number;
 - Description of sample;
 - Quantity of sample; and
 - Date of shipment.

A.6.3 CHAIN-OF-CUSTODY CONTROL

After the samples are collected, chain-of-custody procedures must be followed to establish a written record of sample handling and movement between the sampling site and the analytical laboratory. Each shipping container should include a chain-of-custody form completed in triplicate by the sampling personnel. One copy of this form should be kept by the sampling contractor after sample delivery to the analytical laboratory; the other two copies should be retained at the laboratory. One of the laboratory copies will become a part of the permanent record for the sample and will be returned with the sample analytical results. The chain-of-custody form should contain the following information:

- Unique sample identification number;
- Sample collector's printed name and signature;
- Date and time of collection;
- Sample location;
- Sample matrix;
- Sample size and container;
- Chemical preservatives added;
- Analyses requested;
- Signatures of individuals involved in the chain of possession; and
- Inclusive dates of possession.

The chain-of-custody documentation should be placed inside the shipping container so that it will be immediately apparent to the laboratory personnel receiving the container, but cannot be damaged or lost during transport. The shipping container is to be sealed so that it will be obvious if the seal has been tampered with or broken.

A.6.4 SAMPLING RECORDS

In order to provide complete documentation of the sampling event, detailed records must be maintained by the field scientist. At a minimum, these records must include the following information:

- Sample location (facility name);
- Sample identification;
- Sample location map or detailed sketch;
- Date and time of sampling;
- Sampling method;
- Field observations of
 - Sample appearance,
 - Sample odor;
- Weather conditions;
- Water level prior to purging (ground-water samples);
- Total well depth (ground-water samples);
- Purge volume (ground-water samples);
- Water level after purging (ground-water samples);
- Well condition (ground-water samples);
- Sample depth;
- Sampler's identification;
- Field measurements such as pH, temperature, specific conductivity, dissolved oxygen concentration, and redox potential (ground-water samples); and
- Any other relevant information.

SECTION A-7

AQUIFER CHARACTERIZATION METHODOLOGIES

Adequate characterization of the ground-water flow and contaminant transport system is an important component of the monitored natural attenuation demonstration. The following sections describe methodologies that are recommended to characterize the hydrogeologic system.

A.7.1 HYDRAULIC CONDUCTIVITY

Hydraulic conductivity is a measure of an aquifer's capacity to transmit water and governs ground-water flow and contaminant transport in the subsurface. Methods for determining hydraulic conductivity in the field can include slug tests, pumping tests, and downhole flowmeter measurements. Hydraulic conductivity can also be measured during penetration with a cone penetrometer by measuring the transient pressure excursions in the pore water in front of the cone using a cone equipped with a pressure transducer in contact with the pore water. The method selected for a given site will depend on the dimensions, locations, and screened intervals of site wells and monitoring points; site stratigraphy; equipment availability; budget; and waste handling requirements.

A.7.1.1 Pump Tests

A pumping test involves pumping one well at a constant rate for a specified length of time and collecting periodic water level measurements in both the pumped well and nearby observation wells in order to determine aquifer hydraulic characteristics representative of a large area. As a rule, pumping tests provide more representative measurements of hydraulic parameters; however, they require a greater commitment of resources (time, money, and equipment) that cannot be afforded by all projects. In addition, for pumping test results to be representative, site hydrogeologic conditions should not change appreciably over short distances. This section outlines methods that can be used for conducting pump tests in both confined and unconfined aquifers. For a more detailed discussion of how to conduct a pumping test, the reader is referred to the work of Dawson and Istok (1991), Kruseman and de Ridder (1991), and Driscoll (1986).

The interpretation of aquifer pumping test data is not unique. Similar sets of data can be obtained from various combinations of geologic conditions. The interpretation of pumping test data is discussed in Appendix C of this protocol document.

A.7.1.1.1 Pumping Test Design

Prior to performing an aquifer pumping test, all available site and regional hydrogeologic information should be assembled and evaluated. Such data should include ground-water flow direction, hydraulic gradients, other geohydraulic properties, site stratigraphy, well construction details, regional water level trends, and the performance of other pumping wells in the vicinity of the test area. This information is used to select test duration, proposed pumping rates, and pumping well and equipment dimensions.

The precise location of an aquifer test is chosen to be representative of the area under study. In addition, the location is selected on the basis of numerous other criteria, including:

- Size of the investigation area;
- Uniformity and homogeneity of the aquifer;
- Distribution of contaminant sources and dissolved contaminant plumes;
- Location of known or suspected recharge or barrier boundary conditions;
- Availability of pumping and/or observation wells of appropriate dimension and screened at the desired depth; and
- Requirements for handling discharge.

The dimensions and screened interval of the pumping well must be appropriate for the tested aquifer. For example, the diameter of the well must be sufficient to accommodate pumping equip-

ment capable of sustaining the desired flow rate at the given water depth. In addition, if testing a confined aquifer that is relatively thin, the pumping well should be screened for the entire thickness of the aquifer. For an unconfined aquifer, the wells should be screened in the bottom one-third or two-thirds of the saturated zone.

Any number of observation wells may be used. The number chosen is contingent upon both cost and the need to obtain the maximum amount of accurate and reliable data. If three or more observation wells are to be installed, and there is a known boundary condition, the wells should be placed along a radial line extending from the pumping well toward the boundary, with one well placed perpendicular to the line of observation wells to determine whether radial anisotropy exists within the aquifer. If two observation wells are to be installed, they should be placed in a triangular pattern, non-equidistant from the pumping well. Observation wells should be located at distances and depths appropriate for the planned method for analysis of the aquifer test data. Observation well spacing should be determined based upon expected drawdown conditions that are the result of the studies of geohydraulic properties, proposed pumping test duration, and proposed pumping rate. Preliminary pumping results should also be used (if available). Not all projects can afford the luxury of preliminary testing.

The equipment needed to perform aquifer pumping tests includes:

- Pumps
- Gate valve
- Electrical generator
- Flow meter with totalizer
- Water level indicators
- Pressure gauge
- Field logbook/forms
- Pressure transducers and data recorder
- Engineer's tape calibrated to 0.01 ft
- 5-gallon pail
- Conductivity meter, pH meter, and thermometer
- Barometer
- Semi-log and log-log graph paper
- Portable computer
- Field printer for data
- Type matching curves
- Meter and stopwatch for discharge measurement
- Hose or pipe for transfer of water
- Adequately sized tank for storing contaminated water

Pumping equipment should conform to the size of the well and be capable of delivering the estimated range of pumping rates. The selection of flow meter, gate valve, and water transfer lines should be based on anticipated rates of water discharge. Both the discharge rate and test duration should be considered when selecting a tank for storing discharge water if the water cannot be released directly to the ground, sanitary sewer, storm sewer, or nearby water treatment facility.

In areas of severe winter climates, where the frost line may extend to depths of several feet, pumping tests should be avoided during cold weather months where the water table is less than 12 feet from the surface. Under certain conditions, the frozen soil acts as a confining stratum, and combined with leaky aquifer and delayed storage characteristics, test results may be unreliable.

A.7.1.1.2 Preparation for Testing

Barometric changes may affect water levels in wells, particularly in semiconfined and confined aquifers. A change in barometric pressure may cause a change in the water level. Therefore, for at least 24 hours prior to performing a pumping test, barometric pressure and water levels in the test well, observation wells, and a well beyond the influence of the pumping well should be measured hourly to establish trends in ground-water level fluctuation. If a trend is apparent, the barometric pressure should be used to develop curves depicting the change in water level versus time. These curves should be used to correct the water levels observed during the pumping test. Ground-water levels in the background well as well as barometric pressures should continue to be recorded throughout the duration of the test.

Test wells should undergo preliminary pumping or step drawdown tests prior to the actual test. This will enable fines to be flushed from the adjacent formation near the well and a steady flow rate to be established. The preliminary pumping should determine the maximum drawdown in the well and the proper pumping rate should be determined by step drawdown testing. The aquifer should then be given time to recover before the actual pumping test begins (as a rule-of-thumb, one day).

A record should be maintained in the field logbook of the times of pumping and discharge of other wells in the area, and if their radii of influence intersect the cone of depression of the test well. All measurements and observations should be recorded in a field notebook or on an Aquifer Test Data Form. If data loggers with transducers are used, field measurements should be performed in case of data logger malfunction.

A.7.1.1.3 Conducting the Pumping Test

Immediately prior to starting the pump, the water levels should be measured and recorded for all wells to determine the static water levels upon which all drawdowns will be based. Data loggers should be reset for each well to a starting water level of 0.0 foot.

Water pumped from an unconfined aquifer during a pumping test should be disposed of in such a manner as not to allow the aquifer to be recharged by infiltration during the test. This means that the water must be piped away from the well and associated observation wells. Recharge could adversely affect the results. Also, if contaminated water is pumped during the test, the water must be stored and treated or disposed of according to the project work plan for the study. The discharge water may be temporarily stored in drums, a lined, bermed area, or tanks. If necessary, it should be transported and staged in a designated secure area.

The discharge rate should be measured frequently throughout the test and controlled to maintain it as constant as possible, after the initial excess discharge has been stabilized. This can be achieved by using a control valve.

The pitch or rhythm of the pump or generators provides a check on performance. If there is a sudden change in pitch, the discharge should be checked immediately and proper adjustments to the control valve or the engine speed should be made, if necessary. Do not allow the pump to break suction during the test. Allow for maximum drawdown of the well during the step drawdown test. If done properly, the flow control valve can be pre-set for the test and will not have to be adjusted during pumping. If the pump does shut down during the test, make necessary adjustments and restart the test after the well has stabilized. For a confined aquifer, the water level in the pumping well should not be allowed, if possible, to fall below the bottom of the upper confining stratum during a pumping test.

At least 10 measurements of drawdown for each log cycle of time should be made both in the test well and the observation wells. Data loggers can be set to record in log time, which is very useful for data analysis. A suggested schedule for recording water level measurements made by hand is as follows:

- 0 to 10 minutes - 0.5, 1.0, 2.5, 2.0, 2.5, 3.0, 4.5, 6.5, 8, and 10 minutes. It is important in the early part of the test to record with maximum accuracy the time at which readings are taken.
- 10 to 100 minutes - 10, 15, 20, 25, 30, 40, 50, 65, 80, and 100 minutes.
- Then, at 1-hour intervals from 120 minutes to 1,440 minutes (one day) and every 2 hours after 1 complete day.

Initially, there should be sufficient field personnel to station one person at each well used in the pumping test (unless an automatic water-level recording system has been installed). After the first two hours of pumping, two people are usually sufficient to complete the test. A third person may be needed when treatment of the pumped water is required prior to discharge. It is advisable for at least

one field member to have experience in the performance of pump tests, and for all field personnel to have a basic familiarity with conducting the test and gathering data.

Field personnel should be aware that electronic equipment sometimes fails in the field. Some field crews have experienced complete loss of data due to failure of a logger or transducer. It is a good idea to record data in the field logbook or on a manual form as the data are produced. That way, the data are not lost should the equipment fail.

The discharge or pumping rate should be measured with a flow meter that also has a totalizer. When the pumping is complete, the total gallons pumped are divided by the time of pumping to obtain the average discharge rate for the test. Periodic checking and recording of the pumping rate during the test also should be performed.

The total pumping time for a test depends on the type of aquifer and degree of accuracy desired. Economizing on the duration of pumping is not recommended. More reliable results are obtained if pumping continues until the cone of depression achieves a stabilized condition. The cone of depression will continue to expand at an ever-decreasing rate until recharge of the aquifer equals the pumping rate, and a steady-state condition is established. The time required for steady-state flow to occur may vary from a few hours to years.

Under normal conditions, it is a good practice to continue a pumping test in a confined aquifer for at least 24 hours, and in an unconfined aquifer for a minimum of 72 hours. A longer duration of pumping may reveal the presence of boundary conditions or delayed yield. Use of portable computers allows time/drawdown plots to be made in the field. If data loggers are used to monitor water levels, hard copies of the data printed on field printers should be obtained before transporting the logger back to the office for downloading.

A.7.1.2 Slug Tests

A slug test is a single-well hydraulic test used to determine the hydraulic conductivity of an aquifer in the immediate vicinity of the well. Because hydraulic conductivity varies spatially within and between aquifers and because slug test results reflect aquifer conditions only in the immediate vicinity of the tested well, slug tests should be conducted in as many wells as possible at a site. Slug tests can be used for both confined and unconfined aquifers that have transmissivities of less than approximately 7,000 square feet per day (ft²/day). Slug tests are accomplished by removing a solid slug (rising head) or introducing a solid slug (falling head), and then allowing the water level to stabilize while taking water level measurements at closely spaced time intervals. The method presented herein discusses the use of falling head and rising head slug tests in sequence. The analysis of slug test data is discussed in Appendix C.

Slug testing should not proceed until water level measurements show that static water level equilibrium has been achieved. Unvented wells should be uncapped at least 24 hours prior to initiating the test in order to allow the static water level to come to equilibrium. The protective casing should remain locked during this time to prevent vandalism. During the slug test, the water level change should be influenced only by the introduction or removal of the slug volume. Other factors, such as inadequate well development or extended pumping, may lead to inaccurate results. It is the field scientist's responsibility to decide when static equilibrium has been reached in the well.

The following equipment is needed to conduct a slug test:

- Teflon[®], PVC, or metal slug
- Nylon or polypropylene rope
- Electric water level indicator
- Pressure transducer/sensor
- Field logbook/forms
- Automatic data recorder (such as the Hermit Environmental Data Logger[®], In-Situ, Inc. Model SE1000B, or equal)

The falling head test is the first step in the two-step slug-testing procedure. The following steps describe the recommended falling head slug test procedure:

1. Decontaminate all downhole equipment.
2. Record pre-test information including: well number, personnel, climatic data, ground surface elevation, measuring point elevation, equipment identifications, and date.
3. Measure and record the static water level in the well to the nearest 0.01 foot.
4. Lower the decontaminated pressure transducer into the well and allow the displaced water to return to within 0.01 foot of the original static level.
5. Lower the decontaminated slug into the well to just above the water surface in the well.
6. Start the data logger and quickly lower the slug below the water table being careful not to disturb the pressure transducer. Follow the owner's manual for proper operation of the data logger.
7. Terminate data recording when the water level has recovered at least 80 percent from the initial slug displacement.

Immediately following completion of the falling head test, the rising head test is performed.

The following steps describe the rising head slug test procedure:

1. Measure the static water level in the well to the nearest 0.01 foot to ensure that it has returned to the static water level.
2. Initiate data recording and quickly withdraw the slug from the well. Follow the owner's manual for proper operation of the data logger.
3. Terminate data recording when the water level has recovered at least 80 percent from the initial slug displacement.

It is advisable to produce hard copies or backup electronic copies of the data logger output (draw-down vs. time) daily and before transporting the logger from the field site.

A.7.1.3 Downhole Flow Meter Measurements

Downhole flow meter measurements are used to investigate the relative vertical distribution of horizontal hydraulic conductivity in an open borehole or the screened portion of a well. These measurements are useful for identifying zones of elevated hydraulic conductivity that may contribute to preferential flow pathways and affect contaminant migration. Methodologies for interpreting data from borehole surveys are described by Molz *et al.* (1994).

Flowmeter measurements should be performed at 1- to 3-foot intervals in test wells during both ambient conditions and induced flow conditions. Test data may be analyzed using the methods described by Molz *et al.* (1994) to define the relative distribution of horizontal hydraulic conductivity within the screened interval of each well. Final results should be presented in tabular and graphical forms and accompanied by appropriate interpretation and discussion. Estimates of bulk hydraulic conductivity from previous aquifer tests or results of single-well tests conducted in conjunction with the flow meter survey can be used to estimate the absolute hydraulic conductivity distribution at each well.

Borehole flowmeters should be calibrated prior to testing. Generally, 0.5-inch-ID and 1.0-inch-ID probes will be calibrated using a range of volumetric flowrates potentially applicable to most sites [e.g., approximately 0.04 liters per minute (L/min) to 10 L/min]. The following nine steps outline general procedures that can be used to conduct a downhole flow meter survey at a given location.

- Measure the water level, organic liquid (NAPL) interfaces (if present), and total depth (TD) prior to initiating the test.
- Calibrate the flow meter for the range of anticipated flow velocities before introducing the flow meter into the well or borehole.
- Lower the flow meter to the bottom of the well/borehole.

- Slowly withdraw the flow meter, pausing to obtain measurements at intervals of approximately 1 to 3 feet, depending on site conditions. This will provide a baseline under static (ambient) conditions.
- Conduct a short-term, single-well pumping test in the test well to stress the aquifer.
- Record drawdown using an electronic data logger with a pressure transducer.
- Monitor and adjust the ground-water extraction rate, as necessary, to maintain constant flow.
- Obtain the profile of the vertical flow at the same elevations occupied during the ambient profile upon stabilization of the flow rate.
- Analyze the data collected during the tests to estimate relative distribution of flow into the tested wells and the relative hydraulic conductivity distribution at each location (Molz *et al.*, 1994).

A.7.2 HYDRAULIC GRADIENT

Hydraulic gradient, defined as the change in ground-water elevation with distance, is a key parameter governing the direction and rate of ground-water flow and contaminant migration. Because ground water can flow in both the horizontal and vertical planes, both horizontal and vertical gradients are required for a successful demonstration of monitored natural attenuation. Hydraulic gradients are generally calculated on the basis of ground-water elevations measured in site monitoring wells or monitoring points using an electric water level indicator. Therefore, for the most complete representation of site hydrogeology, it is important to measure ground-water elevations from as many depths and locations as available. Interpretation of ground-water elevations and the subsequent calculations for hydraulic gradient are discussed in Appendix C.

A.7.3 DIRECT MEASUREMENT OF GROUND-WATER VELOCITY

Ground-water velocity is directly related to contaminant velocity; therefore, a determination of groundwater velocity is critical to the fate and transport portion of a demonstration of monitored natural attenuation. Typically, ground-water velocity is estimated from the hydraulic conductivity, hydraulic gradient, and effective porosity as described in Appendix C; however, direct measurement of ground-water velocity can be obtained from dye tracer studies.

APPENDIX B

IMPORTANT PROCESSES AFFECTING THE FATE AND TRANSPORT OF ORGANIC COMPOUNDS IN THE SUBSURFACE

TABLE OF CONTENTS - APPENDIX B

B-1	INTRODUCTION	B1-6
B.1.1	FATE AND TRANSPORT MECHANISMS	B1-6
B.1.2	MATHEMATICAL DESCRIPTION OF SOLUTE FATE AND TRANSPORT	B1-6
B-2	NONDESTRUCTIVE ATTENUATION MECHANISMS	B2-9
B.2.1	ADVECTION	B2-9
B.2.2	HYDRODYNAMIC DISPERSION	B2-9
B.2.2.1	Mechanical Dispersion	B2-11
B.2.2.2	Molecular Diffusion	B2-13
B.2.2.3	Equation of Hydrodynamic Dispersion	B2-13
B.2.2.4	One-Dimensional Advection-Dispersion Equation	B2-14
B.2.3	SORPTION	B2-15
B.2.3.1	Mechanisms of Sorption	B2-16
B.2.3.2	Sorption Models and Isotherms	B2-17
B.2.3.2.1	Langmuir Sorption Model	B2-17
B.2.3.2.2	Freundlich Sorption Model	B2-18
B.2.3.3	Distribution Coefficient	B2-19
B.2.3.4	Coefficient of Retardation	B2-20
B.2.3.4.1	Determining the Coefficient of Retardation using K_{oc}	B2-20
B.2.3.4.2	Determining the Coefficient of Retardation using Laboratory Tests	B2-24
B.2.3.5	One-Dimensional Advection-Dispersion Equation with Retardation	B2-25
B.2.4	VOLATILIZATION	B2-26
B.2.5	RECHARGE	B2-26
B-3	DESTRUCTIVE ATTENUATION MECHANISMS - BIOLOGICAL	B3-29
B.3.1	OVERVIEW OF BIODEGRADATION	B3-30
B.3.2	BIODEGRADATION OF ORGANIC COMPOUNDS VIA USE AS A PRIMARY GROWTH SUBSTRATE	B3-33
B.3.2.1	Aerobic Biodegradation of Primary Substrates	B3-33
B.3.2.1.1	Aerobic Oxidation of Petroleum Hydrocarbons	B3-35
B.3.2.1.2	Aerobic Oxidation of Chlorinated Ethenes	B3-35
B.3.2.1.3	Aerobic Oxidation of Chlorinated Ethanes	B3-35
B.3.2.1.4	Aerobic Oxidation of Chlorobenzenes	B3-36
B.3.2.2	Anaerobic Biodegradation of Primary Substrates	B3-36
B.3.2.2.1	Anaerobic Oxidation of Petroleum Hydrocarbons	B3-36
B.3.2.2.2	Anaerobic Oxidation of Chlorinated Ethenes	B3-36
B.3.2.2.3	Anaerobic Oxidation of Chlorinated Ethanes	B3-36
B.3.2.2.4	Anaerobic Oxidation of Chlorobenzenes	B3-37
B.3.3	BIODEGRADATION OF ORGANIC COMPOUNDS VIA USE AS AN ELECTRON ACCEPTOR (REDUCTIVE DECHLORINATION)	B3-37
B.3.3.1	Reductive Dechlorination of Chlorinated Ethenes	B3-38

B.3.3.2	Reductive Dechlorination of Chlorinated Ethanes	B3-40
B.3.3.3	Reductive Dechlorination of Chlorobenzenes	B3-40
B.3.4	BIODEGRADATION OF ORGANIC COMPOUNDS VIA COMETABOLISM	B3-40
B.3.5	THERMODYNAMIC CONSIDERATIONS	B3-41
B.3.6	ONE-DIMENSIONAL ADVECTION-DISPERSION EQUATION WITH RETARDATION AND BIODEGRADATION	B3-59
B-4	DESTRUCTIVE ATTENUATION MECHANISMS - ABIOTIC	B4-60
B.4.1	HYDROLYSIS AND DEHYDROHALOGENATION	B4-60
B.4.1.1	Hydrolysis	B4-60
B.4.1.2	Dehydrohalogenation	B4-61
B.4.2	REDUCTION REACTIONS	B4-63

FIGURES

No.	Title	Page
B.2.1	Breakthrough curve in one dimension showing plug flow with continuous source resulting from advection only	B2-10
B.2.2	Breakthrough curve in one dimension showing plug flow with instantaneous source resulting from advection only	B2-10
B.2.3	Plume migration in two dimensions (plan view) showing plume migration resulting from advective flow only with continuous and instantaneous source	B2-10
B.2.4	Physical processes causing mechanical dispersion at the microscopic scale	B2-11
B.2.5	Breakthrough curve in one dimension showing plug flow with instantaneous source resulting from advection only and the combined processes of advection and hydrodynamic dispersion	B2-12
B.2.6	Breakthrough curve in one dimension showing plug flow with instantaneous source resulting from advection only and the combined processes of advection and hydrodynamic dispersion	B2-12
B.2.7	Relationship between dispersivity and scale	B2-15
B.2.8	Breakthrough curve in one dimension showing plug flow with continuous source resulting from advection only; the combined processes of advection and hydrodynamic dispersion; and the combined processes of advection, hydrodynamic dispersion, and sorption	B2-16
B.2.9	Breakthrough curve in one dimension showing plug flow with instantaneous source resulting from advection only; the combined processes of advection and hydrodynamic dispersion; and the combined processes of advection, hydrodynamic dispersion, and sorption	B2-16
B.2.10	Characteristic adsorption isotherm shapes	B2-18
B.2.11	Plot of sorbed concentration versus equilibrium concentration	B2-25
B.3.1	Breakthrough curve in one dimension showing plug flow with continuous source resulting from advection only; the combined processes of advection and hydrodynamic dispersion; the combined processes of advection, hydrodynamic dispersion, and sorption; and the combined processes of advection, hydrodynamic dispersion, sorption, and biodegradation	B3-30
B.3.2	Breakthrough curve in one dimension showing plug flow with instantaneous source resulting from advection only; the combined processes of advection and hydrodynamic dispersion; the combined processes of advection, hydrodynamic dispersion, and sorption; and the combined processes of advection, hydrodynamic dispersion, sorption, and biodegradation	B3-30
B.3.3	Oxidation-reduction potentials for various oxidation-reduction reactions	B3-34
B.3.4	Expected sequence of microbially-mediated redox reactions and Gibbs free energy of the reaction	B3-42

TABLES

No.	Title	Page
B.1.1	Summary of Important Processes Affecting Solute Fate and Transport	B1-7
B.2.1	Values of Aqueous Solubility and K_{oc} for Selected Chlorinated Compounds.....	B2-22
B.2.2	Values of Aqueous Solubility and K_{oc} for BTEX and Trimethylbenzene Isomers	B2-23
B.2.3	Data from Hypothetical Batch Test Experiment	B2-25
B.2.4	Henry's Law Constants and Vapor Pressures for Common Fuel Hydrocarbons and Chlorinated Solvents	B2-27
B.3.1	Biologic and Abiotic Degradation Mechanisms for Various Anthropogenic Organic Compounds	B3-29
B.3.2	Some Microorganisms Capable of Degrading Organic Compounds	B3-31
B.3.3	Trends in Contaminant, Electron Acceptor, Metabolic By-product, and Total Alkalinity Concentrations During Biodegradation	B3-34
B.3.4	Sources, Donors, Acceptors, and Products of Reported Reductive Dechlorinating Laboratory Systems	B3-39
B.3.5	Electron Donor and Electron Acceptor Half Cell Reactions	B3-43--B3-44
B.3.6	Gibbs Free Energy of Formation for Species used in Half Cell Reactions and Coupled Oxidation-Reduction Reactions	B3-45--B3-46
B.3.7	Coupled Oxidation-Reduction Reactions	B3-47--B3-58
B.4.1	Approximate Half-Lives of Abiotic Hydrolysis and Dehydrohalogenation Reactions Involving Chlorinated Solvents	B4-62

SECTION B-1

INTRODUCTION

B.1.1 FATE AND TRANSPORT MECHANISMS

This appendix presents an overview of the important processes affecting the fate and transport of chlorinated solvents and fuel hydrocarbons dissolved in ground water. The environmental fate and transport of a contaminant is controlled by the compound's physical and chemical properties and the nature of the subsurface media through which the compound is migrating. Several processes are known to cause a reduction in the concentration and/or mass of a contaminant dissolved in ground water. Those processes that result only in the reduction of a contaminant's concentration but not of the total contaminant mass in the system are termed "nondestructive." Those processes that result in degradation of contaminants are referred to as "destructive." Nondestructive processes include advection, hydrodynamic dispersion (mechanical dispersion and diffusion), sorption, dilution, and volatilization. Destructive processes include biodegradation and abiotic degradation mechanisms. Biodegradation may be the dominant destructive attenuation mechanism acting on a contaminant, depending upon the type of contaminant and the availability of electron donors or carbon sources. Abiotic degradation processes are also known to degrade chlorinated solvents; where biodegradation is not occurring, these may be the only destructive processes operating. However, the rates of abiotic processes are generally slow relative to biodegradation rates.

Remediation by monitored natural attenuation results from the integration of all the subsurface attenuation mechanisms (both nondestructive and destructive) operating at a given site. Table B.1.1 summarizes the processes that affect fate and transport of chlorinated solvents and fuel hydrocarbons dissolved in ground water. Important factors to consider include:

- The compound's soil/water distribution coefficient (K_d);
- The compound's organic carbon/water partition coefficient (K_{oc});
- The compound's octanol/water partition coefficient (K_{ow});
- The compound's water solubility;
- The compound's vapor pressure;
- The compound's Henry's Law constant (air/water partition coefficient, H);
- Indigenous bacterial population;
- Hydraulic conductivity of aquifer materials;
- Porosity of aquifer materials;
- Total organic carbon content of aquifer materials;
- Bulk density of aquifer materials;
- Aquifer heterogeneity; and
- Ambient ground-water geochemistry.

Nondestructive attenuation mechanisms are discussed in Section B-2. Biodegradation is discussed in Section B-3. Abiotic degradation mechanisms are discussed in Section B-4. It is important to separate nondestructive from destructive attenuation mechanisms during the natural attenuation demonstration. The methods for correcting apparent attenuation caused by nondestructive attenuation mechanisms are discussed in Appendix C.

B.1.2 MATHEMATICAL DESCRIPTION OF SOLUTE FATE AND TRANSPORT

The partial differential equation describing contaminant migration and attenuation in the saturated zone includes terms for advection, dispersion, sorption, and degradation. In one dimension, the partial differential equation describing solute transport in the saturated zone is:

$$\frac{\partial C}{\partial t} = \frac{D_x}{R} \frac{\partial^2 C}{\partial x^2} - \frac{v_x}{R} \frac{\partial C}{\partial x} \pm Q_s \quad \text{eq. B.1.1}$$

Table B.1.1 Summary of Important Processes Affecting Solute Fate and Transport

Process	Description	Dependencies	Effect
Advection	Movement of solute by bulk ground-water movement.	Dependent on aquifer properties, mainly hydraulic conductivity and effective porosity, and hydraulic gradient. Independent of contaminant properties.	Main mechanism driving contaminant movement in the subsurface.
Dispersion	Fluid mixing due to ground-water movement and aquifer heterogeneities.	Dependent on aquifer properties and scale of observation. Independent of contaminant properties.	Causes longitudinal, transverse, and vertical spreading of the plume. Reduces solute concentration.
Diffusion	Spreading and dilution of contaminant due to molecular diffusion.	Dependent on contaminant properties and concentration gradients. Described by Fick's Laws.	Diffusion of contaminant from areas of relatively high concentration to areas of relatively low concentration. Generally unimportant relative to dispersion at most ground-water flow velocities.
Sorption	Reaction between aquifer matrix and solute whereby relatively hydrophobic organic compounds become sorbed to organic carbon or clay minerals.	Dependent on aquifer matrix properties (organic carbon and clay mineral content, bulk density, specific surface area, and porosity) and contaminant properties (solubility, hydrophobicity, octanol-water partitioning coefficient).	Tends to reduce apparent solute transport velocity and remove solutes from the ground water via sorption to the aquifer matrix.
Recharge (Simple Dilution)	Movement of water across the water table into the saturated zone.	Dependent on aquifer matrix properties, depth to ground water, surface water interactions, and climate.	Causes dilution of the contaminant plume and may replenish electron acceptor concentrations, especially dissolved oxygen.
Volatilization	Volatilization of contaminants dissolved in ground water into the vapor phase (soil gas).	Dependent on the chemical's vapor pressure and Henry's Law constant.	Removes contaminants from ground water and transfers them to soil gas.
Biodegradation	Microbially mediated oxidation-reduction reactions that degrade contaminants.	Dependent on ground-water geochemistry, microbial population and contaminant properties. Biodegradation can occur under aerobic and/or anaerobic conditions.	May ultimately result in complete degradation of contaminants. Typically the most important process acting to truly reduce contaminant mass.
Abiotic Degradation	Chemical transformations that degrade contaminants without microbial facilitation; only halogenated compounds are subject to these mechanisms in the ground-water environment.	Dependent on contaminant properties and ground-water geochemistry.	Can result in partial or complete degradation of contaminants. Rates typically much slower than for biodegradation.
Partitioning from NAPL	Partitioning from NAPL into ground water. NAPL plumes, whether mobile or residual, tend to act as a continuing source of ground-water contamination.	Dependent on aquifer matrix and contaminant properties, as well as ground-water mass flux through or past NAPL plume.	Dissolution of contaminants from NAPL represents the primary source of dissolved contamination in ground water.

Where:

C = solute concentration [M]

t = time [T]

D_x = hydrodynamic dispersion [L^2/T]

R = coefficient of retardation [dimensionless]

x = distance along flow path [L]

v_x = transport velocity in x direction [L/T]

Q_s = general source or sink term for reactions involving the production or loss of solute (e.g., biodegradation) [$M/L^3/T$]

The degradation of organic contaminants commonly can be approximated using first-order kinetics. In one dimension, the partial differential equation describing solute transport with first-order decay in the saturated zone is given by:

$$\frac{\partial C}{\partial t} = \frac{D_x}{R} \frac{\partial^2 C}{\partial x^2} - \frac{v_x}{R} \frac{\partial C}{\partial x} - \lambda C \quad \text{eq. B.1.2}$$

Where:

C = concentration [M/L^3]

t = time [T]

D_x = hydrodynamic dispersion [L^2/T]

x = distance along flow path [L]

R = coefficient of retardation [dimensionless]

v_x = transport velocity in x direction [L/T]

λ = first-order decay rate [T^{-1}]

These equations serve to illustrate how the processes of advection, dispersion, sorption, and biotic and abiotic degradation are integrated to describe the fate and transport of solutes in the saturated zone. These relationships were derived using the continuity (conservation of mass) equation, which states that the rate of change of contaminant mass within a unit volume of porous media is equal to the flux of contaminant into the unit volume minus the flux out of the unit volume (Freeze and Cherry, 1979). Processes governing flux into the unit volume include advection and hydrodynamic dispersion (including mechanical dispersion and diffusion). Processes governing flux out of the unit volume include advection, hydrodynamic dispersion, dilution, sorption, and chemical reactions (most notably biodegradation). The change in solute concentration may, therefore, be stated mathematically as:

$$\text{Change in Solute Concentration} = \text{Flux In} - \text{Flux Out} \pm \text{Reactions}$$

The following sections describe the most significant reactions affecting this mass balance (and therefore the fate and transport) of organic contaminants in the subsurface. Methods for evaluating the flux through the system will be discussed in Appendix C.

SECTION B-2

NONDESTRUCTIVE ATTENUATION MECHANISMS

B.2.1 ADVECTION

Advective transport is the transport of solutes by the bulk movement of ground water. Advection is the most important process driving dissolved contaminant migration in the subsurface. The linear groundwater velocity in the direction parallel to ground-water flow caused by advection is given by:

$$v_x = -\frac{K}{n_e} \frac{dH}{dL} \quad \text{eq. B.2.1}$$

Where:

v_x = average linear velocity [L/T]

K = hydraulic conductivity [L/T]

n_e = effective porosity [L³/L³]

dH/dL = hydraulic gradient [L/L]

Solute transport by advection alone yields a sharp solute concentration front. Immediately ahead of the front, the solute concentration is equal to the background concentration (generally zero). At and behind the advancing solute front, the concentration is equal to the initial contaminant concentration at the point of release. This is referred to as plug flow and is illustrated in Figures B.2.1, B.2.2, and B.2.3. In reality, the advancing front spreads out due to the processes of dispersion and diffusion, as discussed in Section B-3, and is retarded by sorption and biodegradation, as discussed in Sections B-4 and B-5, respectively.

The one-dimensional advective transport component of the advection-dispersion equation is given by:

$$\frac{\partial C}{\partial t} = -v_x \frac{\partial C}{\partial x} \quad \text{eq. B.2.2}$$

Where:

v_x = average linear velocity [L/T]

C = contaminant concentration [M/L³]

t = time [T]

x = distance along flow path [L]

Equation B.2.2 considers only advective transport of the solute. In some cases this may be a fair approximation for simulating solute migration because advective transport is the main force behind contaminant migration. However, because of dispersion, diffusion, sorption, and biodegradation, this equation generally must be combined with the other components of the modified advection-dispersion equation (equation B.1.1) to obtain an accurate mathematical description of solute transport.

B.2.2 HYDRODYNAMIC DISPERSION

Hydrodynamic dispersion is the process whereby a contaminant plume spreads out in directions that are longitudinal and transverse to the direction of plume migration. Dispersion of organic solutes in an aquifer is an important consideration when modeling remediation by natural attenuation. Dispersion of a contaminant dilutes the concentrations of the contaminant, and introduces the contaminant into relatively pristine portions of the aquifer where it may admix with more electron acceptors crossgradient to the direction of ground-water flow. Two very different processes cause

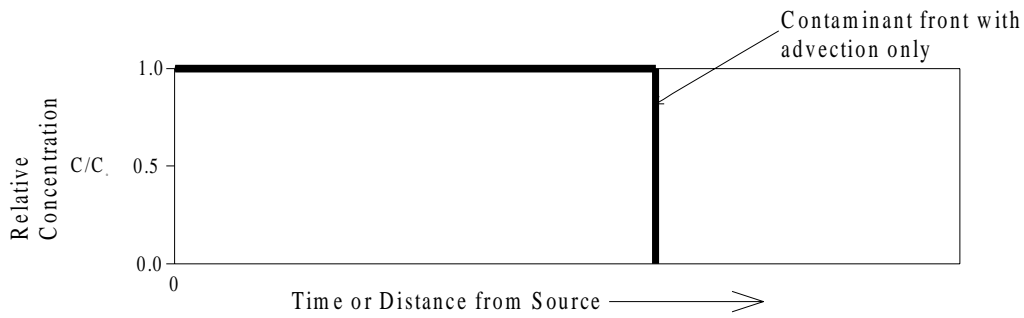

Figure B.2.1 Breakthrough curve in one dimension showing plug flow with continuous source resulting from advection only.

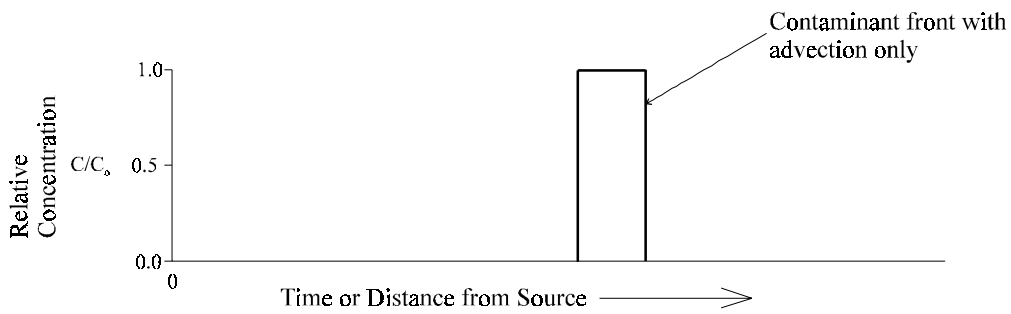

Figure B.2.2 Breakthrough curve in one dimension showing plug flow with instantaneous source resulting from advection only.

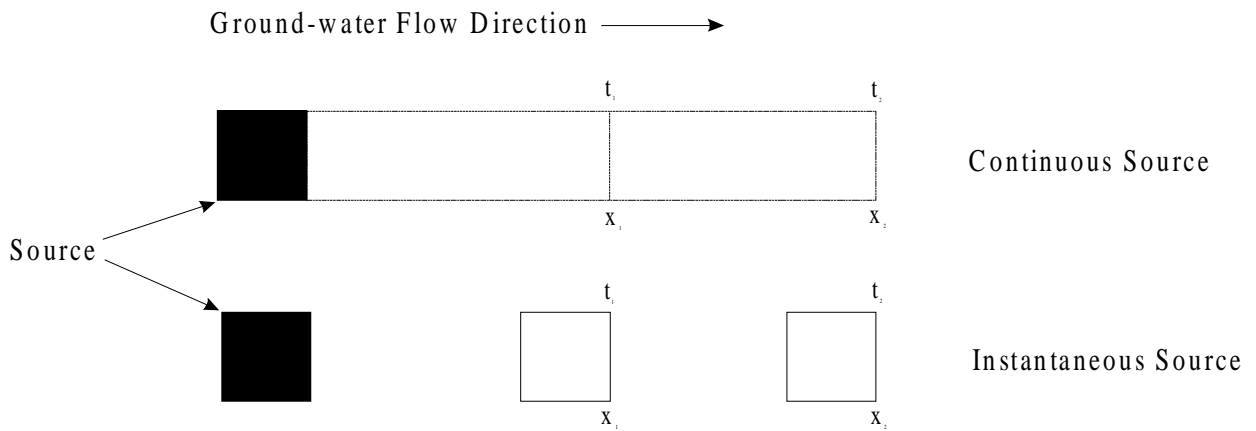

Figure B.2.3 Plume migration in two dimensions (plan view) showing plume migration resulting from advective flow only with continuous and instantaneous sources.

hydrodynamic dispersion; mechanical dispersion and molecular diffusion. The variable describing hydrodynamic dispersion, D , is the sum of mechanical dispersion and molecular diffusion. Mechanical dispersion is the dominant mechanism causing hydrodynamic dispersion at normal ground-water velocities. At extremely low ground-water velocities, molecular diffusion can become the dominant mechanism of hydrodynamic dispersion. Molecular diffusion is generally ignored for most ground-water studies. The following sections describe these processes and how they are incorporated into the modified advection-dispersion equation (Equation B.1.1).

B.2.2.1 Mechanical Dispersion

As defined by Domenico and Schwartz (1990), mechanical dispersion is mixing that occurs as a result of local variations in velocity around some mean velocity of flow. With time, a given volume of solute will gradually become more dispersed as different portions of the mass are transported at the differing velocities. In general, the main cause of variations of both rate and direction of transport velocities is the heterogeneity of the porous aquifer medium. These heterogeneities are present at scales ranging from microscopic (e.g., pore to pore) to macroscopic (e.g., well to well) to megascopic (e.g., a regional aquifer system).

Three processes are responsible for mechanical dispersion on the microscopic scale (Figure B.2.4). The first process is the variation in flow velocity through pores of various sizes. As ground water flows through a porous medium, it flows more slowly through large pores than through smaller pores. The second cause of mechanical dispersion is tortuosity, or flow path length. As ground water flows through a porous medium, some of the ground water follows less tortuous (shorter) paths, while some of the ground water takes more tortuous (longer) paths. The longer the flow path, the slower the average linear velocity of the ground water and the dissolved contaminant. The final process causing mechanical dispersion is variable friction within an individual pore. Groundwater traveling close to the center of a pore experiences less friction than ground water traveling next to a mineral grain, and therefore moves faster. These processes cause some of the contaminated ground water to move faster than the average linear velocity of the ground water and some to move slower. This variation in average velocity of the solute causes dispersion of the contaminant.

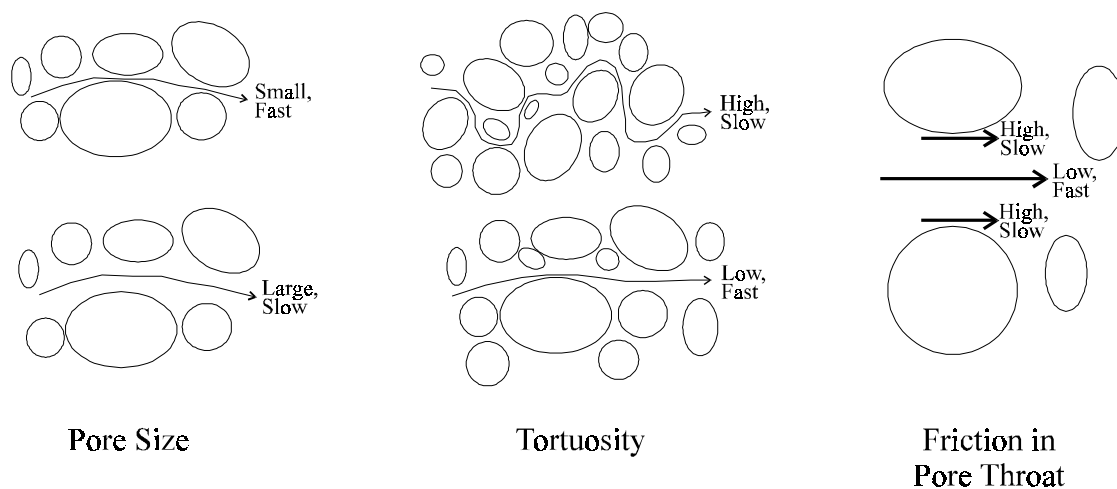

Figure B.2.4 Physical processes causing mechanical dispersion at the microscopic scale.

Heterogeneity at the macroscopic and megascopic scales also creates variability in ground water and solute velocities, therefore producing dispersion on a larger scale. Geologic features that con-

tribute to dispersion at the macroscopic scale include stratification characteristics such as changing unit geometry, discontinuous units, and contrasting lithologies, and permeability characteristics such as nonuniform permeability, directional permeability, and trending permeability (Domenico and Schwartz, 1990). Even in aquifer material that appears to be homogeneous, relatively small changes in the fraction of fine sediment can change hydraulic conductivity characteristics enough to produce significant variations in fluid and solute velocities and thus introduce dispersion. Larger geological features will introduce dispersion at the megascopic scale. At this scale, structural features such as faults, dipping strata, folds, or contacts will create inhomogeneity, as will stratigraphic features such as bedding or other depositional structures.

As a result of dispersion, the solute front travels at a rate that is faster than would be predicted based solely on the average linear velocity of the ground water. The overall result of dispersion is spreading and mixing of the contaminant plume with uncontaminated ground water. Figures B.2.5 and B.2.6 illustrate the effects of hydrodynamic dispersion on an advancing solute front. The component of hydrodynamic dispersion contributed by mechanical dispersion is given by the relationship:

$$\text{Mechanical Dispersion} = \alpha_x v_x \quad \text{eq. B.2.3}$$

Where:

v_x = average linear groundwater velocity [L/T]

α_x = dispersivity [L]

Mechanical dispersion has two components, longitudinal dispersion and transverse (both horizontal and vertical) dispersion. Longitudinal dispersion is the spreading of a solute in a direction parallel to the direction of ground-water flow. On the microscopic scale, longitudinal dispersion

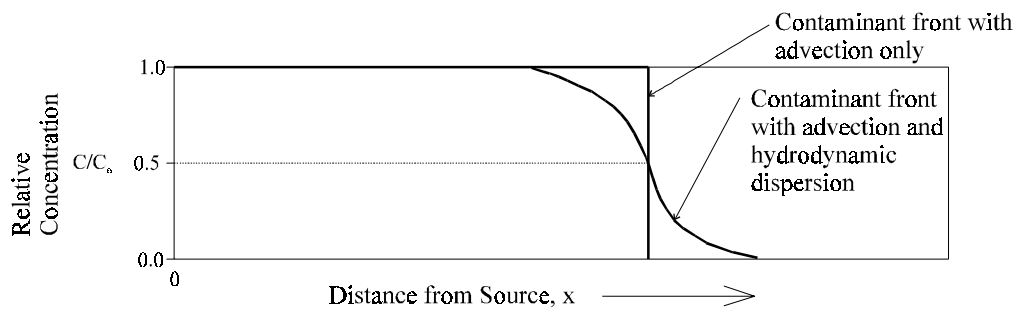

Figure B.2.5 Breakthrough curve in one dimension showing plug flow with continuous source resulting from advection only and the combined processes of advection and hydrodynamic dispersion.

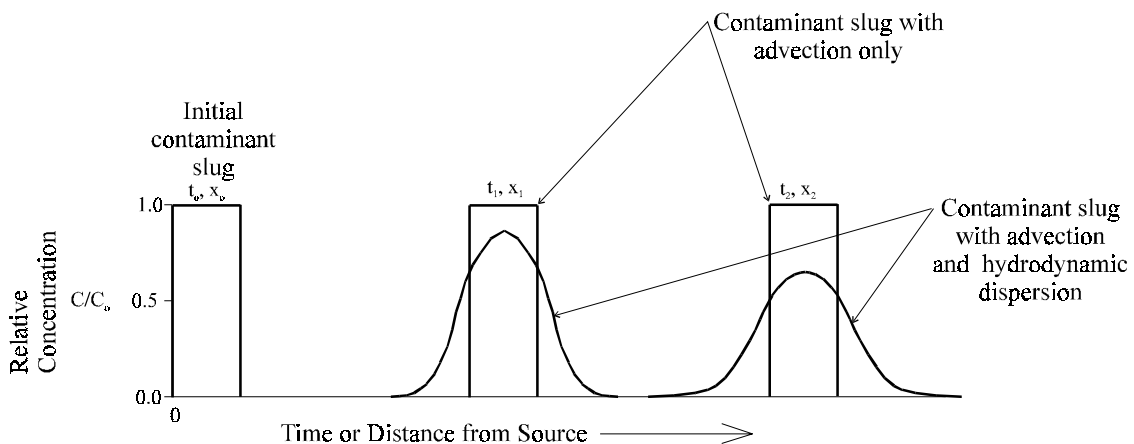

Figure B.2.6 Breakthrough curve in one dimension showing plug flow with instantaneous source resulting from advection only and the combined processes of advection and hydrodynamic dispersion.

occurs because of velocity changes due to variations in pore size, friction in the pore throat, and tortuosity. Transverse dispersion is the spreading of a solute in directions perpendicular to the direction of ground-water flow. Transverse dispersion on the microscopic scale is caused by the tortuosity of the porous medium, which causes flow paths to branch out from the centerline of the contaminant plume.

B.2.2.2 Molecular Diffusion

Molecular diffusion occurs when concentration gradients cause solutes to migrate from zones of higher concentration to zones of lower concentration, even in the absence of ground-water flow. Molecular diffusion is only important at low ground-water velocities, and therefore can be ignored in areas with high ground-water velocities (Davis *et al.*, 1993).

The molecular diffusion of a solute in ground water is described by Fick's Laws. Fick's First Law applies to the diffusive flux of a dissolved contaminant under steady-state conditions and, for the one-dimensional case, is given by:

$$F = -D \frac{dC}{dx} \quad \text{eq. B.2.4}$$

Where:

F = mass flux of solute per unit area of time [M/T]

D = diffusion coefficient (L²/T)

C = solute concentration (M/L³)

$\frac{dC}{dx}$ = concentration gradient (M/L³/L)

For systems where the dissolved contaminant concentrations are changing with time, Fick's Second Law must be applied. The one-dimensional expression of Fick's Second Law is:

$$\frac{dC}{dt} = D \frac{d^2C}{dx^2} \quad \text{eq. B.2.5}$$

Where:

$\frac{dC}{dt}$ = change in concentration with time [M/T]

The process of diffusion is slower in porous media than in open water because the ions must follow more tortuous flow paths (Fetter, 1988). To account for this, an effective diffusion coefficient, D*, is used.

The effective diffusion coefficient is expressed quantitatively as (Fetter, 1988):

$$D^* = wD \quad \text{eq. B.2.6}$$

Where:

w = empirical coefficient determined by laboratory experiments [dimensionless]

The value of w generally ranges from 0.01 to 0.5 (Fetter, 1988).

B.2.2.3 Equation of Hydrodynamic Dispersion

Hydrodynamic dispersion, D, has two components, mechanical dispersion and molecular diffusion. For one-dimensional flow, hydrodynamic dispersion is represented by the following equation (Freeze and Cherry, 1979):

$$D_x = \alpha_x v_x + D^* \quad \text{eq. B.2.7}$$

Where:

D_x = longitudinal coefficient of hydrodynamic dispersion in the x direction [L²/T]

α_x = longitudinal dispersivity [L]

v_x = average linear ground-water velocity [L/T]

D* = effective molecular diffusion [L²/T]

Dispersivity is a parameter that is characteristic of the porous medium through which the contaminant migrates. Dispersivity represents the spreading of a contaminant over a given length of flow, and therefore has units of length. It is now commonly accepted (on the basis of empirical evidence) that as the scale of the plume or the system being studied increases, the dispersivity will also increase. Therefore, dispersivity is scale-dependent, but at a given scale, data compiled by Gelhar *et al.* (1985 and 1992) show that dispersivity may vary over three orders of magnitude. The data of Gelhar *et al.* (1992) are presented on Figure B.2.7 (with permission from Newell *et al.*, 1996).

Several approaches can be used to estimate longitudinal dispersivity, α_x , on the field scale (i.e., macroscopic to megascopic scales). One technique involves conducting a tracer test. Although this is potentially the most reliable method, time and monetary constraints can be prohibitive. Another method commonly used to estimate dispersivity when implementing a solute transport model is to start with a longitudinal dispersivity of 0.1 times the plume length (Lallemand-Barres and Peaudecerf, 1978; Pickens and Grisak, 1981; Spitz and Moreno, 1996). This assumes that dispersivity varies linearly with scale. However, Xu and Eckstein (1995) evaluated the same data presented by Gelhar *et al.* (1992) and, by using a weighted least-squares method, developed the following relationship for estimating dispersivity:

$$\alpha_x = 0.83(\text{Log}_{10}L_p)^{2.414} \quad \text{eq. B.2.8}$$

Where:

α_x = longitudinal dispersivity [L]

L_p = plume length [L]

Both relationships are shown on Figure B.2.7. In either case, the value derived for dispersivity will be an estimate at best, given the great variability in dispersivity for a given plume length. However, for modeling studies, an initial estimate is needed, and these relationships provide good starting points for a modeling study.

In addition to estimating longitudinal dispersivity, it may be necessary to estimate the transverse and vertical dispersivities (α_T and α_z , respectively) for a given site. Several empirical relationships between longitudinal dispersivity and transverse and vertical dispersivity have been described. Commonly, α_T is estimated as $0.1\alpha_x$ (based on data from Gelhar *et al.*, 1992), or as $0.33\alpha_x$ (ASTM, 1995; US EPA, 1986). Vertical dispersivity (α_z) may be estimated as $0.05\alpha_x$ (ASTM, 1995), or as $0.025\alpha_x$ to $0.1\alpha_x$ (US EPA, 1986).

Some solute transport modelers will start with an accepted literature value for the types of materials found in the aquifer matrix. After selecting initial dispersivity values, the contaminant transport model is calibrated by adjusting the dispersivities (along with other transport parameters, as necessary) within the range of accepted literature values until the modeled and observed contaminant distribution patterns match (Anderson, 1979). This is a two-step process. The first step is to calibrate the flow model to the hydraulic conditions present at the site. After the ground-water flow model is calibrated to the hydraulics of the system, the contaminant transport model is calibrated by trial and error using various values for dispersivity. There is no unique solution because several hydraulic parameters, including hydraulic conductivity, effective porosity, and dispersivity, are variable within the flow system (Anderson, 1979; Davis *et al.*, 1993), and other transport parameters such as retardation and biodegradation may not be well-defined.

B.2.2.4 One-Dimensional Advection-Dispersion Equation

The advection-dispersion equation is obtained by adding hydrodynamic dispersion to equation B.2.2. In one dimension, the advection-dispersion equation is given by:

$$\frac{\partial C}{\partial t} = D_x \frac{\partial^2 C}{\partial x^2} - v_x \frac{\partial C}{\partial x} \quad \text{eq. B.2.9}$$

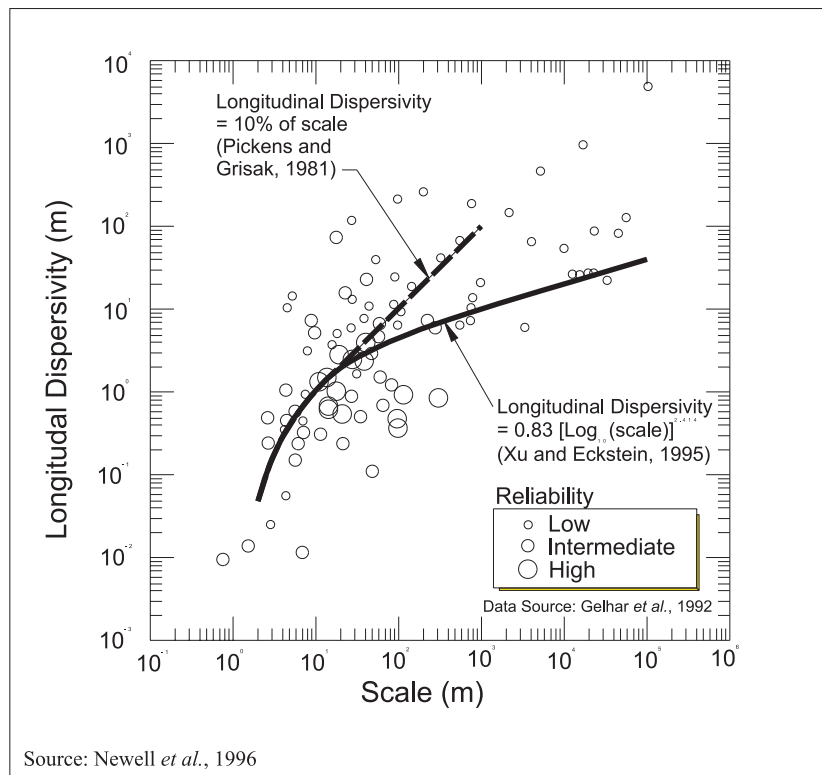

Figure B.2.7 Relationship between dispersivity and scale.

Where:

v_x = average linear velocity [L/T]

C = contaminant concentration [M/L³]

D_x = hydrodynamic dispersion [L²/T]

t = time [T]

x = distance along flow path [L]

This equation considers both advection and hydrodynamic dispersion. Because of sorption and biodegradation, this equation generally must be combined with the other components of the modified advection-dispersion equation presented as equation B.1.1 to obtain an accurate mathematical description of solute transport.

B.2.3 SORPTION

Many organic contaminants, including chlorinated solvents and BTEX, are removed from solution by sorption onto the aquifer matrix. Sorption is the process whereby dissolved contaminants partition from the ground water and adhere to the particles comprising the aquifer matrix. Sorption of dissolved contamination onto the aquifer matrix results in slowing (retardation) of the contaminant relative to the average advective ground-water flow velocity and a reduction in dissolved BTEX concentrations in ground water. Sorption can also influence the relative importance of volatilization and biodegradation (Lyman *et al.*, 1992). Figures B.2.8 and B.2.9 illustrate the effects of sorption on an advancing solute front.

Keep in mind that sorption is a reversible reaction and that at a given solute concentration, some portion of the solute is partitioning to the aquifer matrix and some portion is also desorbing and reentering solution. As solute concentrations change, the relative amounts of contaminant that are sorbing and desorbing will change. For example, as solute concentrations decrease (perhaps due to

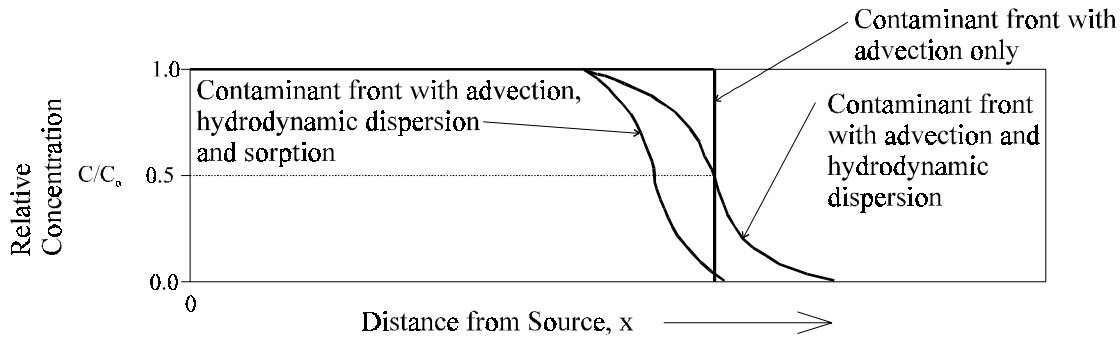

Figure B.2.8 Breakthrough curve in one dimension showing plug flow with continuous source resulting from advection only; the combined processes of advection and hydrodynamic dispersion; and the combined processes of advection, hydrodynamic dispersion, and sorption.

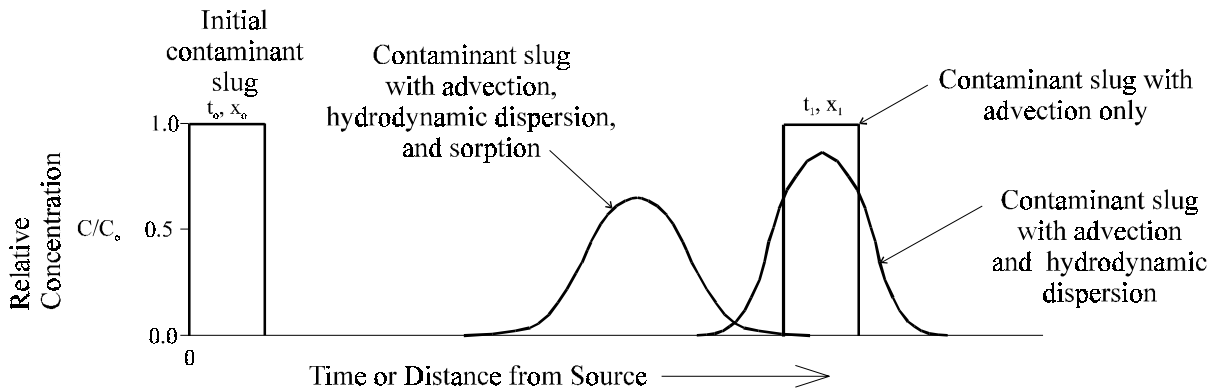

Figure B.2.9 Breakthrough curve in one dimension showing plug flow with instantaneous source resulting from advection only; the combined processes of advection and hydrodynamic dispersion; and the combined processes of advection, hydrodynamic dispersion, and sorption.

plume migration or solute biodegradation and dilution), the amount of contaminant reentering solution will likely increase. The affinity of a given compound for the aquifer matrix will not be sufficient to permanently isolate it from ground water, although for some compounds, the rates of desorption may be so slow that the loss of mass may be considered permanent for the time scale of interest. Sorption, therefore, does not permanently remove solute mass from ground water; it merely retards migration. It is this slowing of contaminant migration that must be understood in order to effectively predict the fate of a dissolved contaminant. This section provides information on how retardation coefficients are determined in the laboratory. It is not the intent of this document to instruct people in how to perform these experiments; this information is provided for informational purposes only. Linear isotherms and previously determined soil sorption coefficients (K_{oc}) are generally used to estimate sorption and retardation.

B.2.3.1 Mechanisms of Sorption

Sorption of dissolved contaminants is a complex phenomenon caused by several mechanisms, including London-van der Waals forces, Coulomb forces, hydrogen bonding, ligand exchange, chemisorption (covalent bonding between chemical and aquifer matrix), dipole-dipole forces, dipole-induced dipole forces, and hydrophobic forces. Because of their nonpolar molecular structure, hydrocarbons most commonly exhibit sorption through the process of hydrophobic bonding. When

the surfaces comprising the aquifer matrix are less polar than the water molecule, as is generally the case, there is a strong tendency for the nonpolar contaminant molecules to partition from the ground water and sorb to the aquifer matrix. This phenomenon is referred to as hydrophobic bonding and is an important factor controlling the fate of many organic pollutants in soils (Devinny *et al.*, 1990). Two components of an aquifer have the greatest effect on sorption: organic matter and clay minerals. In most aquifers, the organic fraction tends to control the sorption of organic contaminants.

B.2.3.2 Sorption Models and Isotherms

Regardless of the sorption mechanism, it is possible to determine the amount of sorption to be expected when a given dissolved contaminant interacts with the materials comprising the aquifer matrix. Bench-scale experiments are performed by mixing water-contaminant solutions of various concentrations with aquifer materials containing various amounts of organic carbon and clay minerals. The solutions are then sealed with no headspace and left until equilibrium between the various phases is reached. The amount of contaminant left in solution is then measured.

Both environmental conservative isotherms (ECI) and constant soil to solution isotherms (CSI) can be generated. The ECI study uses the same water concentration but changes the soil to water ratio. In CSI isotherm studies, the concentration of contaminant in water is varied while the amount of water and sediment is constant. In some instances, actual contaminated water from the site is added. Typically, the samples are continually rotated and concentrations measured with time to document equilibrium. True equilibrium may require hundreds of hours of incubation but 80 to 90 percent of equilibrium may be achieved in one or two days.

The results are commonly expressed as a plot of the concentration of chemical sorbed ($\mu\text{g/g}$) versus the concentration remaining in solution ($\mu\text{g/L}$). The relationship between the concentration of chemical sorbed (C_a) and the concentration remaining in solution (C_l) at equilibrium is referred to as the sorption isotherm because the experiments are performed at constant temperature.

Sorption isotherms generally exhibit one of three characteristic shapes depending on the sorption mechanism. These isotherms are referred to as the Langmuir isotherm, the Freundlich isotherm, and the linear isotherm (a special case of the Freundlich isotherm). Each of these sorption isotherms, and related equations, are discussed in the following sections.

B.2.3.2.1 Langmuir Sorption Model

The Langmuir model describes sorption in solute transport systems wherein the sorbed concentration increases linearly with increasing solute concentration at low concentrations and approaches a constant value at high concentrations. The sorbed concentration approaches a constant value because there are a limited number of sites on the aquifer matrix available for contaminant sorption. This relationship is illustrated in Figure B.2.10. The Langmuir equation is described mathematically as (Devinny *et al.*, 1990):

$$C_a = \frac{KC_l b}{1 + KC_l} \quad \text{eq. B.2.10}$$

Where:

C_a = sorbed contaminant concentration (mass contaminant/mass soil)

K = equilibrium constant for the sorption reaction ($\mu\text{g/g}$)

C_l = dissolved contaminant concentration ($\mu\text{g/ml}$)

b = number of sorption sites (maximum amount of sorbed contaminant)

The Langmuir model is appropriate for highly specific sorption mechanisms where there are a limited number of sorption sites. This model predicts a rapid increase in the amount of sorbed contaminant as contaminant concentrations increase in a previously pristine area. As sorption sites become filled, the amount of sorbed contaminant reaches a maximum level equal to the number of sorption sites, b .

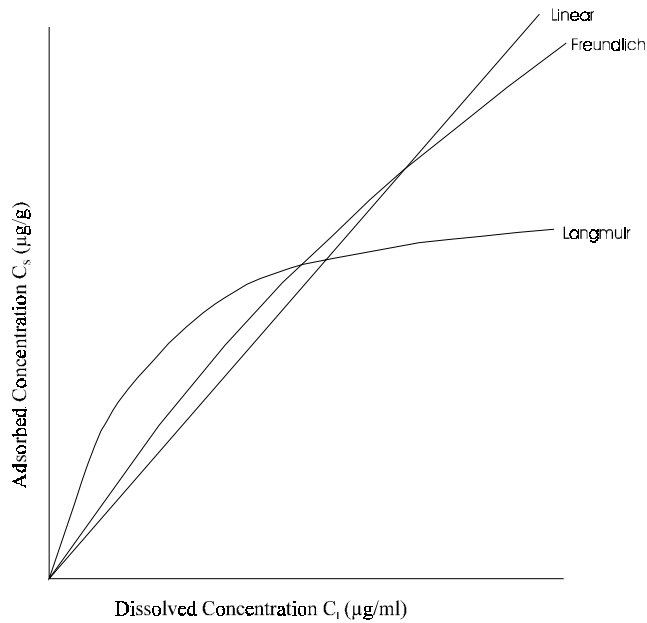

Figure B.2.10 Characteristic adsorption isotherm shapes.

B.2.3.2.2 Freundlich Sorption Model

The Langmuir isotherm model can be modified if the number of sorption sites is large (assumed infinite) relative to the number of contaminant molecules. This is generally a valid assumption for dilute solutions (e.g., downgradient from a petroleum hydrocarbon spill in the dissolved BTEX plume) where the number of unoccupied sorption sites is large relative to contaminant concentrations. The Freundlich model is expressed mathematically as (Devinny *et al.*, 1990):

$$C_a = K_d C_l^{1/n} \quad \text{eq. B.2.11}$$

Where:

K_d = distribution coefficient

C_a = sorbed contaminant concentration (mass contaminant/mass soil, mg/g)

C_l = dissolved concentration (mass contaminant/volume solution, (mg/ml)

n = chemical-specific coefficient

The value of n in this equation is a chemical-specific quantity that is determined experimentally. Values of $1/n$ typically range from 0.7 to 1.1, but may be as low as 0.3 and as high as 1.7 (Lyman *et al.* 1992).

The simplest expression of equilibrium sorption is the linear sorption isotherm, a special form of the Freundlich isotherm that occurs when the value of n is 1. The linear isotherm is valid for a dissolved species that is present at a concentration less than one half of its solubility (Lyman *et al.*, 1992). This is a valid assumption for BTEX compounds partitioning from fuel mixtures into ground water. Dissolved BTEX concentrations resulting from this type of partitioning are significantly less than the pure compound's solubility in pure water. The linear sorption isotherm is expressed as (Jury *et al.*, 1991):

$$C_a = K_d C_l \quad \text{eq. B.2.12}$$

Where:

K_d = distribution coefficient (slope of the isotherm, ml/g).

C_a = sorbed contaminant concentration (mass contaminant/mass soil, µg/g)

C_l = dissolved contaminant concentration (mass contaminant/volume solution, µg/ml)

The slope of the linear isotherm is the distribution coefficient, K_d .

B.2.3.3 Distribution Coefficient

The most commonly used method for expressing the distribution of an organic compound between the aquifer matrix and the aqueous phase is the distribution coefficient, K_d , which is defined as the ratio of the sorbed contaminant concentration to the dissolved contaminant concentration:

$$K_d = \frac{C_a}{C_l} \quad \text{eq. B.2.13}$$

Where:

K_d = distribution coefficient (slope of the sorption isotherm, ml/g)

C_a = sorbed concentration (mass contaminant/mass soil or $\mu\text{g/g}$)

C_l = dissolved concentration (mass contaminant/volume solution or $\mu\text{g/ml}$)

The transport and partitioning of a contaminant is strongly dependent on the chemical's soil/water distribution coefficient and water solubility. The distribution coefficient is a measure of the sorption/desorption potential and characterizes the tendency of an organic compound to be sorbed to the aquifer matrix. The higher the distribution coefficient, the greater the potential for sorption to the aquifer matrix. The distribution coefficient is the slope of the sorption isotherm at the contaminant concentration of interest. The greater the amount of sorption, the greater the value of K_d . For systems described by a linear isotherm, K_d is a constant. In general terms, the distribution coefficient is controlled by the hydrophobicity of the contaminant and the total surface area of the aquifer matrix available for sorption. Thus, the distribution coefficient for a single compound will vary with the composition of the aquifer matrix. Because of their extremely high specific surface areas (ratio of surface area to volume), the organic carbon and clay mineral fractions of the aquifer matrix generally present the majority of sorption sites in an aquifer.

Based on the research efforts of Ciccioli *et al.* (1980), Karickhoff *et al.* (1979), and Schwarzenbach and Westall (1981), it appears that the primary adsorptive surface for organic chemicals is the organic fraction of the aquifer matrix. However, there is a "critical level of organic matter" below which sorption onto mineral surfaces is the dominant sorption mechanism (McCarty *et al.*, 1981). The critical level of organic matter, below which sorption appears to be dominated by mineral-solute interactions, and above which sorption is dominated by organic carbon-solute interactions, is given by (McCarty *et al.*, 1981):

$$f_{oc_c} = \frac{A_s}{200} \frac{1}{K_{ow}^{0.84}} \quad \text{eq. B.2.14}$$

Where:

f_{oc_c} = critical level of organic matter (mass fraction)

A_s = surface area of mineralogical component of the aquifer matrix (m^2/g)

K_{ow} = octanol-water partitioning coefficient

From this relationship, it is apparent that the total organic carbon content of the aquifer matrix is less important for solutes with low octanol-water partitioning coefficients (K_{ow}). Also apparent is the fact that the critical level of organic matter increases as the surface area of the mineralogical fraction of the aquifer matrix increases. The surface area of the mineralogical component of the aquifer matrix is most strongly influenced by the amount of clay. For compounds with low K_{ow} values in materials with a high clay content, sorption to mineral surfaces could be an important factor causing retardation of the chemical.

Several researchers have found that if the distribution coefficient is normalized relative to the aquifer matrix total organic carbon content, much of the variation in observed K_d values between different soils is eliminated (Dragun, 1988). Distribution coefficients normalized to total organic carbon content are expressed as K_{oc} . The following equation gives the expression relating K_d to K_{oc} :

$$K_{oc} = \frac{K_d}{f_{oc}} \quad \text{eq. B.2.15}$$

Where:

- K_{oc} = soil sorption coefficient normalized for total organic carbon content
- K_d = distribution coefficient
- f_{oc} = fraction total organic carbon (mg organic carbon/mg soil)

In areas with high clay concentrations and low total organic carbon concentrations, the clay minerals become the dominant sorption sites. Under these conditions, the use of K_{oc} to compute K_d might result in underestimating the importance of sorption in retardation calculations, a source of error that will make retardation calculations based on the total organic carbon content of the aquifer matrix more conservative. In fact, aquifers that have a high enough hydraulic conductivity to spread hydrocarbon contamination generally have low clay content. In these cases, the contribution of sorption to mineral surfaces is generally trivial.

Earlier investigations reported distribution coefficients normalized to total organic matter content (K_{om}). The relationship between f_{om} and f_{oc} is nearly constant and, assuming that the organic matter contains approximately 58 percent carbon (Lyman *et al.*, 1992):

$$K_{oc} = 1.724 K_{om} \quad \text{eq. B.2.16}$$

B.2.3.4 Coefficient of Retardation

As mentioned earlier, sorption tends to slow the transport velocity of contaminants dissolved in ground water. The coefficient of retardation, R , is used to estimate the retarded contaminant velocity. The coefficient of retardation for linear sorption is determined from the distribution coefficient using the relationship:

$$R = 1 + \frac{\rho_b K_d}{n} \quad \text{eq. B.2.17}$$

Where:

- R = coefficient of retardation [dimensionless]
- ρ_b = bulk density of aquifer [M/L³]
- K_d = distribution coefficient [L³/M]
- n = porosity [L³/L³]

The retarded contaminant transport velocity, v_c , is given by:

$$v_c = \frac{v_x}{R} \quad \text{eq. B.2.18}$$

Where:

- v_c = retarded contaminant transport velocity [L/T]
- v_x = advective ground-water velocity [L/T]
- R = coefficient of retardation [dimensionless]

Two methods used to quantify the distribution coefficient and amount of sorption (and thus retardation) for a given aquifer/contaminant system are presented below. The first method involves estimating the distribution coefficient by using K_{oc} for the contaminants and the fraction of organic carbon comprising the aquifer matrix. The second method involves conducting batch or column tests to determine the distribution coefficient. Because numerous authors have conducted experiments to determine K_{oc} values for common contaminants, literature values are reliable, and it generally is not necessary to conduct laboratory tests.

B.2.3.4.1 Determining the Coefficient of Retardation using K_{oc}

Batch and column tests have been performed for a wide range of contaminant types and concentrations and aquifer conditions. Numerous studies have been performed using the results of these

tests to determine if relationships exist that are capable of predicting the sorption characteristics of a chemical based on easily measured parameters. The results of these studies indicate that the amount of sorption is strongly dependent on the amount of organic carbon present in the aquifer matrix and the degree of hydrophobicity exhibited by the contaminant (Bailey and White, 1970; Karickhoff *et al.*, 1979; Kenaga and Goring, 1980; Brown and Flagg, 1981; Schwarzenbach and Westall, 1981; Hassett *et al.*, 1983; Chiou *et al.*, 1983). These researchers observed that the distribution coefficient, K_d , was proportional to the organic carbon fraction of the aquifer times a proportionality constant. This proportionality constant, K_{oc} , is defined as given by equation B.2.15. In effect, equation B.2.15 normalizes the distribution coefficient to the amount of organic carbon in the aquifer matrix. Because it is normalized to organic carbon, values of K_{oc} are dependent only on the properties of the compound (not on the type of soil). Values of K_{oc} have been determined for a wide range of chemicals. Table B.2.1 lists K_{oc} values for selected chlorinated compounds, and Table B.2.2 lists K_{oc} values for BTEX and trimethylbenzene.

By knowing the value of K_{oc} for a contaminant and the fraction of organic carbon present in the aquifer, the distribution coefficient can be determined by using the relationship:

$$K_d = K_{oc} f_{oc} \quad \text{eq. B.2.19}$$

When using the method presented in this section to predict sorption of the BTEX compounds, total organic carbon concentrations obtained from the most transmissive aquifer zone should be averaged and used for predicting sorption. This is because the majority of dissolved contaminant transport occurs in the most transmissive portions of the aquifer. In addition, because the most transmissive aquifer zones generally have the lowest total organic carbon concentrations, the use of this value will give a conservative prediction of contaminant sorption and retardation.

Table B.2.1 Values of Aqueous Solubility and K_{oc} for Selected Chlorinated Compounds

Compound	Solubility (mg/L)	K_{oc} (L/Kg)
Tetrachloroethene	150 ^a	263 ^a
Tetrachloroethene		359 ^b
Tetrachloroethene	1,503 ^c	209 - 238 ^c
Trichloroethene	1,100 ^a	107 ^a
Trichloroethene		137 ^b
Trichloroethene	1,100 ^c	87 - 150 ^c
1,1-Dichloroethene	2,250 ^a	64.6 ^a
1,1-Dichloroethene		80.2 ^b
1,1-Dichloroethene	2,500 ^d	150 ^d
<i>cis</i> -1,2-Dichloroethene		80.2 ^b
<i>cis</i> -1,2-Dichloroethene	3,500 ^c	49 ^c
<i>trans</i> -1,2-Dichloroethene	6,300 ^a	58.9 ^a
<i>trans</i> -1,2-Dichloroethene		80.2 ^b
<i>trans</i> -1,2-Dichloroethene	6,300 ^c	36 ^c
Vinyl Chloride	1,100 ^a	2.45 ^a
Vinyl Chloride	2,763 ^d	0.4 - 56 ^d
1,1,1-Trichloroethane	1,495 ^c	183 ^c
1,1,2-Trichloroethane	4,420 ^e	70 ^e
1,1-Dichloroethane	5,060 ^d	40 ^d
1,2-Dichloroethane	8,520 ^c	33 to 152 ^c
Chloroethane	5,710 ^e	33 to 143 ^e
Hexachlorobenzene	0.006 ^f	--
1,2-Dichlorobenzene	156 ^c	272 - 1480 ^c
1,3-Dichlorobenzene	111 ^g	293 to 31,600 ^g
1,4-Dichlorobenzene	74 to 87 ^d	273 to 1833 ^d
Chlorobenzene	472 ^d	83 to 389 ^d
Carbon Tetrachloride	805 ^g	110 ^g
Chloroform	7,950 ^c	<34 ^c
Methylene Chloride	13,000 ^c	48 ^c

^a From Knox et al., 1993

^b From Jeng et al., 1992; Temperature = 20°C

^c From Howard, 1990; Temperature = 25°C

^d From Howard, 1989; Temperature = 25°C

^e From Howard, 1989; Temperature = 20°C

^f ATSDR, 1990; Temperature = 20°C

^g From Howard, 1990; Temperature = 20°C

Table B.2.2 Values of Aqueous Solubility and K_{oc} for BTEX and Trimethylbenzene Isomers

Compound	Solubility (mg/L)	K_{oc} (L/Kg)
Benzene	1750 ^a	87.1 ^a
Benzene		83 ^b
Benzene	1780 ^c	190 ^{c,d,f}
Benzene	1780 ^c	62 ^{c,e,f}
Benzene	1780 ^h	72 ^{h,i}
Benzene*	1780 ^h	79 ^{h,j,*}
Benzene	1780 ^{c,h}	89 ^k
Toluene	515 ^a	151 ^a
Toluene		303 ^b
Toluene	537 ^c	380 ^{c,d,f}
Toluene	537 ^c	110 ^{c,e,f}
Toluene*	537 ^c	190 ^{k,*}
Ethylbenzene	152 ^a	158.5 ^a
Ethylbenzene		519 ^b
Ethylbenzene	167 ^c	680 ^{c,d,f}
Ethylbenzene	167 ^c	200 ^{c,e,f}
Ethylbenzene	140 ^h	501 ^{h,i}
Ethylbenzene*	140 ^h	468 ^{h,j}
Ethylbenzene	167 ^c	398 ^k
o-xylene	152 ^a	128.8 ^a
o-xylene		519 ^b
o-xylene*	152 ^a	422 ^{k,*}
m-xylene	158 ^a	
m-xylene		519 ^b
m-xylene	162 ^c	720 ^{c,d,f}
m-xylene	162 ^c	210 ^{c,e,f}
m-xylene*	162 ^c	405.37 ^{k,*}
p-xylene	198 ^a	204 ^a
p-xylene		519 ^b
p-xylene*	198 ^a	357 ^{k,*}
1,2,3-trimethylbenzene*	75	884 ^{b,*}
1,2,4-trimethylbenzene	59 ^l	884 ^b
1,2,4-trimethylbenzene*	59 ^l	772 ^{k,*}
1,3,5-trimethylbenzene*	72.60 ^g	676 ^{k,*}

^a From Knox et al., 1993

^b From Jeng et al., 1992; Temperature = 20°C

^c From Lyman et al., 1992; Temperature = 25°C

^d Estimated from K_{ow}

^e Estimated from solubility

^f Estimate from solubility generally considered more reliable

^g From Lyman et al., 1992; Temperature = 20°C

^h From Fetter, 1993

ⁱ Average of 12 equations used to estimate K_{oc} from K_{ow} or K_{om}

^j Average of 5 equations used to estimate K_{oc} from Solubility

^k Average using equations from Kenaga and Goring (1980), Means et al. (1980), and Hassett et al. (1983) to estimate K_{oc} from solubility

^l From Sutton and Calder (1975)

* Recommended value

B.2.3.4.2 Determining the Coefficient of Retardation using Laboratory Tests

The distribution coefficient may be quantified in the laboratory using batch or column tests. Batch tests are easier to perform than column tests. Although more difficult to perform, column tests generally produce a more accurate representation of field conditions than batch tests because continuous flow is involved. Knox *et al.* (1993) suggest using batch tests as a preliminary screening tool, followed by column studies to confirm the results of batch testing. The authors of this document feel that batch tests, if conducted properly, will yield sufficiently accurate results for fate and transport modeling purposes provided that sensitivity analyses for retardation are conducted during the modeling.

Batch testing involves adding uncontaminated aquifer material to a number of vessels, adding solutions prepared using uncontaminated ground water from the site mixed with various amounts of contaminants to produce varying solute concentrations, sealing the vessel and shaking it until equilibrium is reached, analyzing the solute concentration remaining in solution, and calculating the amount of contaminant sorbed to the aquifer matrix using mass balance calculations. A plot of the concentration of contaminant sorbed versus dissolved equilibrium concentration is then made using the data for each reaction vessel. The slope of the line formed by connecting each data point is the distribution coefficient. The temperature should be held constant during the batch test, and should approximate that of the aquifer system through which solute transport is taking place.

Table B.2.3 contains data from a hypothetical batch test. These data are plotted (Figure B.2.11) to obtain an isotherm unique to the aquifer conditions at the site. A regression analysis can then be performed on these data to determine the distribution coefficient. For linear isotherms, the distribution coefficient is simply the slope of the isotherm. In this example, $K_d = 0.0146$ L/g. Batch-testing procedures are described in detail by Roy *et al.* (1992).

Column testing involves placing uncontaminated aquifer matrix material in a laboratory column and passing solutions through the column. Solutions are prepared by mixing uncontaminated ground water from the site with the contaminants of interest and a conservative tracer. Flow rate and time are accounted for and samples are periodically taken from the effluent of the column and analyzed to determine contaminant and tracer concentrations. Breakthrough curves are prepared for the contaminants by plotting chemical concentration versus time (or relative concentration versus number of pore volumes). The simplest way to determine the coefficient of retardation (or the distribution coefficient) from the breakthrough curves is to determine the time required for the effluent concentration to equal 0.5 of the influent concentration. This value can be used to determine average velocity of the center of mass of the contaminant. The retardation factor is determined by dividing the average flow velocity through the column by the velocity of the center of mass of the contaminant. The value thus obtained is the retardation factor. The coefficient of retardation also can be determined by curve fitting using the CXTFIT model of Parker and van Genuchten (1984). Breakthrough curves also can be made for the conservative tracer. These curves can be used to determine the coefficient of dispersion by curve fitting using the model of Parker and van Genuchten (1984).

When using the method presented in this section to predict sorption of the BTEX compounds, aquifer samples should be obtained from the most transmissive aquifer zone. This is because the majority of dissolved contaminant transport occurs in the most transmissive portions of the aquifer. In addition, because the most transmissive aquifer zones generally have the lowest organic carbon concentrations, the use of these materials will give a conservative prediction of contaminant sorption and retardation.

Table B.2.3 Data from Hypothetical Batch Test Experiment

Initial Concentration (µg/L)	Equilibrium Concentration (µg/L)	Weight of Solid Matrix (g)	Sorbed Concentration* (µg/g)
250	77.3	20.42	1.69
500	150.57	20.42	3.42
1000	297.04	20.42	6.89
1500	510.1	20.42	9.70
2000	603.05	20.42	13.68
3800	1198.7	20.42	25.48
6000	2300.5	20.42	36.23
9000	3560.7	20.42	53.27

* Adsorbed concentration = ((Initial concentration - Equilibrium Concentration) x Volume of Solution) / Weight of Solid Matrix

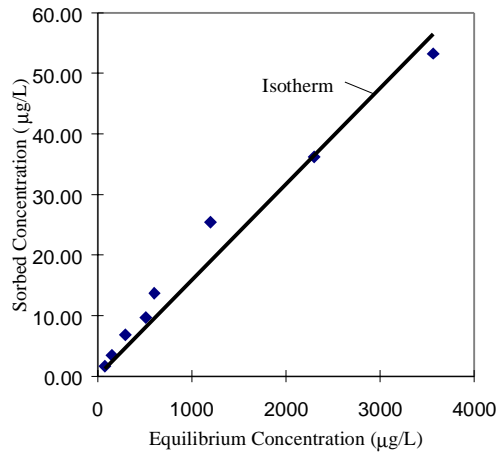

Figure B.2.11 Plot of sorbed concentration vs. equilibrium concentration.

B.2.3.5 One-Dimensional Advection-Dispersion Equation with Retardation

The advection-dispersion equation is obtained by adding hydrodynamic dispersion to equation B.2.2. In one dimension, the advection-dispersion equation is given by:

$$R \frac{\partial C}{\partial t} = D_x \frac{\partial^2 C}{\partial x^2} - v_x \frac{\partial C}{\partial x} \quad \text{eq. B.2.20}$$

Where:

v_x = average linear velocity ground-water velocity [L/T]

R = coefficient of retardation [dimensionless]

C = contaminant concentration [M/L³]

D_x = hydrodynamic dispersion [L²/T]

t = time [T]

x = distance along flow path [L]

This equation considers advection, hydrodynamic dispersion, and sorption (retardation). Because of biodegradation, this equation generally must be combined with the other components of the modified advection-dispersion equation, presented as equation B.1.1, to obtain an accurate mathematical description of solute transport.

B.2.4 VOLATILIZATION

While not a destructive attenuation mechanism, volatilization does remove contaminants from the ground-water system. In general, factors affecting the volatilization of contaminants from ground water into soil gas include the contaminant concentration, the change in contaminant concentration with depth, the Henry's Law constant and diffusion coefficient of the compound, mass transport coefficients for the contaminant in both water and soil gas, sorption, and the temperature of the water (Larson and Weber, 1994).

Partitioning of a contaminant between the liquid phase and the gaseous phase is governed by Henry's Law. Thus, the Henry's Law constant of a chemical determines the tendency of a contaminant to volatilize from ground water into the soil gas. Henry's Law states that the concentration of a contaminant in the gaseous phase is directly proportional to the compound's concentration in the liquid phase and is a constant characteristic of the compound. Stated mathematically, Henry's Law is given by (Lyman *et al.*, 1992):

$$C_a = HC_l \quad \text{eq. B.2.21}$$

Where:

H = Henry's Law Constant (atm m³/mol)

C_a = concentration in air (atm)

C_l = concentration in water (mol/m³)

Henry's Law constants for chlorinated and petroleum hydrocarbons range over several orders of magnitude. For petroleum hydrocarbons, Henry's Law constants (H) for the saturated aliphatics, H range from 1 to 10 atm m³/mol @ 25°C; for the unsaturated and cyclo-aliphatics ranges from 0.1 to 1 atm m³/mol @ 25°C; and for the light aromatics (e.g., BTEX) H ranges from 0.007 to 0.02 atm m³/mol @ 25°C (Lyman *et al.*, 1992). Values of Henry's Law constants for selected chlorinated solvents and the BTEX compounds are given in Table B.2.4. As indicated on the table, values of H for chlorinated compounds also vary over several orders of magnitude, although most are similar to those for BTEX compounds.

The physiochemical properties of chlorinated solvents and the BTEX compounds give them low Henry's Law constants, with the exception of vinyl chloride. Because of the small surface area of the ground-water flow system exposed to soil gas, volatilization of chlorinated solvents and BTEX compounds from ground water is a relatively slow process that, in the interest of being conservative, generally can be neglected when modeling biodegradation. Chiang *et al.* (1989) demonstrated that less than 5 percent of the mass of dissolved BTEX is lost to volatilization in the saturated ground-water environment. Moreover, Rivett (1995) observed that for plumes more than about 1 meter below the air-water interface, little, if any, solvent concentrations will be detectable in soil gas due to the downward ground-water velocity in the vicinity of the water table. This suggests that for portions of plumes more than 1 meter below the water table, very little, if any, mass will be lost due to volatilization. In addition, vapor transport across the capillary fringe can be very slow (McCarthy and Johnson, 1993), thus further limiting mass transfer rates. Because of this, the impact of volatilization on dissolved contaminant reduction can generally be neglected, except possibly in the case of vinyl chloride. However, Rivett's (1995) findings should be kept in mind even when considering volatilization as a mechanism for removal of vinyl chloride from ground water.

B.2.5 RECHARGE

Groundwater recharge can be defined as the entry into the saturated zone of water made available at the water-table surface (Freeze and Cherry, 1979). In recharge areas, flow near the water table is generally downward. Recharge defined in this manner may therefore include not only precipitation that infiltrates through the vadose zone, but water entering the ground-water system due to discharge from surface water bodies (i.e., streams and lakes). Where a surface water body is in

Table B.2.4 Henry's Law Constants and Vapor Pressures for Common Fuel Hydrocarbons and Chlorinated Solvents

Compound	Vapor Pressure (mmHg @ 25°C)	Henry's Law Constant (atm·m ³ /mol)
Benzene	95	0.0054
Ethylbenzene	10	0.0066
Toluene	28.4	0.0067
<i>o</i> -Xylene	10	0.00527
<i>m</i> -Xylene	10	0.007
<i>p</i> -Xylene	10	0.0071
<i>1,2,3</i> -Trimethylbenzene		0.00318
<i>1,2,4</i> -Trimethylbenzene		0.007
<i>1,3,5</i> -Trimethylbenzene		0.006
<i>1,2,4,5</i> -Tetramethylbenzene		0.0249
Tetrachloroethene	14	0.0153
Trichloroethene	57.8	0.0091
1,1-Dichloroethene	591	0.018
<i>cis</i> -1,2-Dichloroethene	200	0.0037
<i>trans</i> -1,2-Dichloroethene	265	0.0072
Vinyl Chloride	2,580	1.22
1,1,1-Trichloroethane	123.7	0.008
1,1,2-Trichloroethane	30.3	0.0012
1,1-Dichloroethane	227	0.0059
1,2-Dichloroethane	78.7	0.00098
Chloroethane	766	0.0085
Hexachlorobenzene	0.0000109	0.00068
1,2-Dichlorobenzene	1.47	0.0012
1,3-Dichlorobenzene	2.3	0.0018
1,4-Dichlorobenzene	1.76	0.0015
Chlorobenzene	11.9	0.0035
Carbon Tetrachloride	113.8	0.0304
Chloroform	246	0.00435
Methylene Chloride	434.9	0.00268

contact with or is part of the ground-water system, the definition of recharge above is stretched slightly. However, such bodies are often referred to as recharging lakes or streams. Recharge of a water table aquifer has two effects on the natural attenuation of a dissolved contaminant plume. Additional water entering the system due to infiltration of precipitation or from surface water will contribute to dilution of the plume, and the influx of relatively fresh, electron-acceptor-charged water will alter geochemical processes and in some cases facilitate additional biodegradation.

Recharge from infiltrating precipitation is the result of a complex series of processes in the unsaturated zone. Description of these processes is beyond the scope of this discussion; however, it is worth noting that the infiltration of precipitation through the vadose zone brings the water into contact with the soil and thus may allow dissolution of additional electron acceptors and possibly organic soil matter (a potential source of electron donors). Infiltration, therefore, provides fluxes of water, inorganic species, and possibly organic species into the ground water. Recharge from surface water bodies occurs when the hydraulic head of the body is greater than that of the adjacent ground water. The surface water may be a connected part of the ground-water system, or it may be perched above the water table. In either case, the water entering the ground-water system will not only aid in dilution of a contaminant plume but it may also add electron acceptors and possibly electron donors to the ground water.

An influx of electron acceptors will tend to increase the overall electron-accepting capacity within the contaminant plume. In addition to the inorganic electron acceptors that may be dissolved in the recharge (e.g., dissolved oxygen, nitrate, or sulfate), the introduction of water with different geochemical properties may foster geochemical changes in the aquifer. For example, iron (II) will be oxidized back to iron (III). Vroblesky and Chapelle (1994) present data from a site where a major rainfall event introduced sufficient dissolved oxygen into the contaminated zone to cause reprecipitation of iron (III) onto mineral grains. This reprecipitation made iron (III) available for reduction by microorganisms, thus resulting in a shift from methanogenesis back to iron (III) reduction (Vroblesky and Chapelle, 1994). Such a shift may be beneficial for biodegradation of compounds used as electron donors, such as fuel hydrocarbons or vinyl chloride. However, these shifts can also make conditions less favorable for reductive dehalogenation.

Evaluating the effects of recharge is typically difficult. The effects of dilution might be estimated if one has a detailed water budget for the system in question, but if a plume has a significant vertical extent, it cannot be known with any certainty what proportion of the plume mass is being diluted by the recharge. Moreover, because dispersivity, sorption, and biodegradation are often not well-quantified, separating out the effects of dilution may be very difficult indeed. Where recharge enters from precipitation, the effects of the addition of electron acceptors may be qualitatively apparent due to elevated electron acceptor concentrations or differing patterns in electron acceptor consumption or byproduct formation in the area of the recharge. However, the effects of short-term variations in such a system (which are likely due to the intermittent nature of precipitation events in most climates) may not be easily understood. Where recharge enters from surface water, the influx of mass and electron acceptors is more steady over time. Quantifying the effects of dilution may be less uncertain, and the effects of electron acceptor replenishment may be more easily identified (though not necessarily quantified).

SECTION B-3

DESTRUCTIVE ATTENUATION MECHANISMS - BIOLOGICAL

Many anthropogenic organic compounds, including certain chlorinated solvents, can be degraded by both biological and abiotic mechanisms. Biological degradation mechanisms are discussed in this section; abiotic degradation mechanisms are discussed in Section B.4. Table B.3.1 summarizes the various biotic and abiotic mechanisms that result in the degradation of anthropogenic organic compounds. Biological degradation mechanisms tend to dominate in most ground-water systems, depending on the type of contaminant and the ground-water chemistry.

Table B.3.1 Biologic and Abiotic Degradation Mechanisms for Various Anthropogenic Organic Compounds

Compound	Degradation Mechanism
PCE	Reductive dechlorination
TCE	Reductive dechlorination, cometabolism
DCE	Reductive dechlorination, direct biological oxidation
Vinyl Chloride	Reductive dechlorination, direct biological oxidation
TCA	Reductive dechlorination, hydrolysis, dehydrohalogenation
1,2-DCA	Reductive dechlorination, direct biological oxidation
Chloroethane	Hydrolysis
Carbon Tetrachloride	Reductive dechlorination, cometabolism, abiotic
Chloroform	Reductive dechlorination, cometabolism
Methylene Chloride	Direct biological oxidation
Chlorobenzenes	Direct biological oxidation, reductive dechlorination, cometabolism
Benzene	Direct biological oxidation
Toluene	Direct biological oxidation
Ethylbenzene	Direct biological oxidation
Xylenes	Direct biological oxidation
1,2-Dibromoethane	Reductive dehalogenation, hydrolysis, direct biological oxidation

Many organic contaminants are biodegraded by microorganisms indigenous to the subsurface environment. During biodegradation, dissolved contaminants are ultimately transformed into innocuous byproducts such as carbon dioxide, chloride, methane, and water. In some cases, intermediate products of these transformations may be more hazardous than the original compound; however, they may also be more easily degraded. Biodegradation of organic compounds dissolved in ground water results in a reduction in contaminant concentration (and mass) and slowing of the contaminant front relative to the average advective ground-water flow velocity. Figures B.3.1 and B.3.2 illustrate the effects of biodegradation on an advancing solute front.

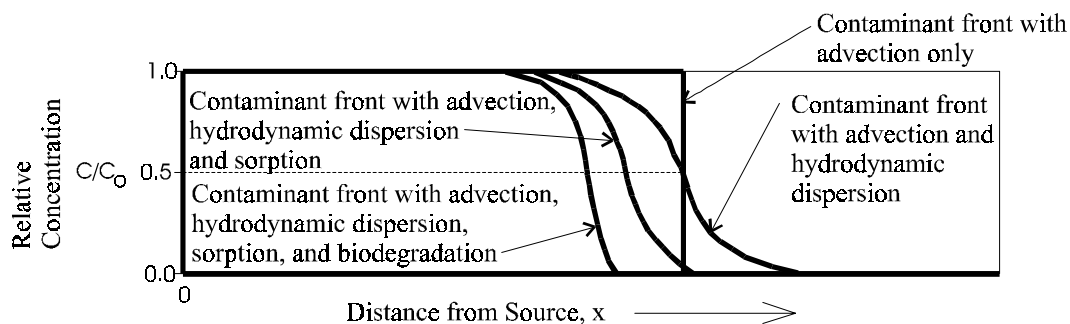

Figure B.3.1 Breakthrough curve in one dimension showing plug flow with continuous source resulting from advection only; the combined processes of advection and hydrodynamic dispersion; the combined processes of advection, hydrodynamic dispersion, and sorption; and the combined processes of advection, hydrodynamic dispersion, sorption, and biodegradation.

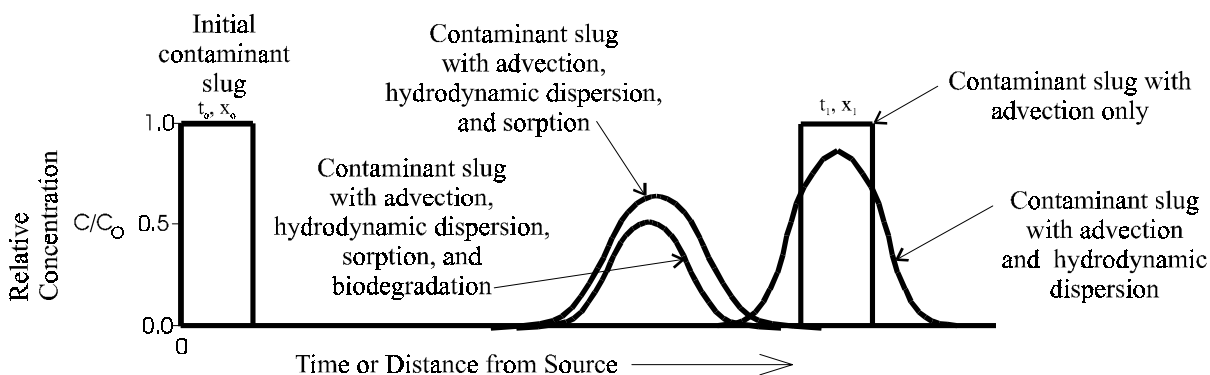

Figure B.3.2 Breakthrough curve in one dimension showing plug flow with instantaneous source resulting from advection only; the combined processes of advection and hydrodynamic dispersion; the combined processes of advection, hydrodynamic dispersion, and sorption; and the combined processes of advection, hydrodynamic dispersion, sorption, and biodegradation.

B.3.1 OVERVIEW OF BIODEGRADATION

As recently as 1975 the scientific literature reported the subsurface/aquifer environment as devoid of significant biological activity. It is now known that soils and shallow sediments contain a large variety of microorganisms, ranging from simple prokaryotic bacteria and cyanobacteria to more complex eukaryotic algae, fungi, and protozoa. Over the past two decades, numerous laboratory and field studies have shown that microorganisms indigenous to the subsurface environment can degrade a variety of organic compounds, including components of gasoline, kerosene, diesel, jet fuel, chlorinated ethenes, chlorinated ethanes, the chlorobenzenes, and many other compounds (e.g., for fuels see Jamison *et al.*, 1975; Atlas, 1981, 1984, and 1988; Young, 1984; Bartha, 1986; B. H. Wilson *et al.*, 1986 and 1990; Barker *et al.*, 1987; Baedeker *et al.*, 1988; Lee, 1988; Chiang *et al.*, 1989; Cozzarelli *et al.*, 1990; Leahy and Colewell, 1990; Alvarez and Vogel, 1991; Evans *et al.*, 1991a and 1991b; Edwards *et al.*, 1992; Edwards and Grbic-Galic, 1992; Thierrin *et al.*, 1992; Malone *et al.*, 1993; Davis *et al.*, 1994a and 1994b; and Lovley *et al.*, 1995; and for chlorinated solvents see Brunner and Leisinger, 1978; Brunner *et al.*, 1980; Rittman and McCarty, 1980; Bouwer *et al.*, 1981;

Table B.3.2 Some Microorganisms Capable of Degrading Organic Compounds (Modified from Riser-Roberts, 1992)

Contaminant	Microorganisms	Comments/ Biodegradability
Benzene	<i>Pseudomonas putida</i> , <i>P. rhodochrous</i> , <i>P. aeruginosa</i> , <i>Acinetobacter sp.</i> , <i>Methylosinus trichosporium</i> OB3b, <i>Nocardia sp.</i> , <i>methanogens</i> , <i>anaerobes</i>	Moderate to High
Toluene	<i>Methylosinus trichosporium</i> OB3b, <i>Bacillus sp.</i> , <i>Pseudomonas sp.</i> , <i>P. putida</i> , <i>Cunninghamella elegans</i> , <i>P. aeruginosa</i> , <i>P. mildenberger</i> , <i>P. aeruginosa</i> , <i>Achromobacter sp.</i> , <i>methanogens</i> , <i>anaerobes</i>	High
Ethylbenzene	<i>Pseudomonas putida</i>	High
Xylenes	<i>Pseudomonas putida</i> , <i>methanogens</i> , <i>anaerobes</i>	High
Jet Fuels	<i>Cladosporium</i> , <i>Hormodendrum</i>	High
Kerosene	<i>Torulopsis</i> , <i>Candidatropicalis</i> , <i>Corynebacterium hydrocarboclastus</i> , <i>Candidaparapsilosis</i> , <i>C. guilliermondii</i> , <i>C. lipolytica</i> , <i>Trichosporon sp.</i> , <i>Rhohosporidium toruloides</i> , <i>Cladosporium resinae</i>	High
Chlorinated Ethenes	<i>Dehalobacter restrictus</i> , <i>Dehalospirillum multivorans</i> , <i>Enterobacter agglomerans</i> , <i>Dehalococcus entheogenes</i> strain 195, <i>Desulfitobacterium sp.</i> strain PCE1, <i>Pseudomonas putida</i> (multiple strains), <i>P. cepacia</i> G4, <i>P. mendocina</i> , <i>Desulfobacterium sp.</i> , <i>Methanobacterium sp.</i> , <i>Methanosarcina sp.</i> strain DCM, <i>Alcaligenes eutrophus</i> JMP 134, <i>Methylosinus trichosporium</i> OB3b, <i>Escherichia coli</i> , <i>Nitrosomonas europaea</i> , <i>Methylocystis parvus</i> OBBP, <i>Mycobacterium sp.</i> , <i>Rhodococcus erythopolis</i>	Moderate
Chlorinated Ethanes	<i>Desulfobacterium sp.</i> , <i>Methanobacterium sp.</i> , <i>Pseudomonas putida</i> , <i>Clostridium sp.</i> , <i>C. sp.</i> strain TCAIIB,	Moderate
Chlorinated Methanes	<i>Acetobacterium woodii</i> , <i>Desulfobacterium sp.</i> , <i>Methanobacterium sp.</i> , <i>Pseudomonas sp.</i> strain KC, <i>Escherichia coli</i> K-12, <i>Clostridium sp.</i> , <i>Methanosarcina sp.</i> , <i>Hyphomicrobium sp.</i> strain DM2,	Moderate
Chlorobenzenes	<i>Alcaligenes sp.</i> (multiple strains), <i>Pseudomonas sp.</i> (multiple strains), <i>P. putida</i> , <i>Staphylococcus epidermis</i>	Moderate to High

Miller and Guengerich, 1982; Roberts *et al.*, 1982; Bouwer and McCarty, 1983; Stucki *et al.*, 1983; Reineke and Knackmuss, 1984; Wilson and Wilson, 1985; Fogel *et al.*, 1986; Egli *et al.*, 1987; Vogel and McCarty, 1987; Vogel *et al.*, 1987; Bouwer and Wright, 1988; Little *et al.*, 1988; Freedman and Gossett, 1989; Sewell and Gibson, 1991; Chapelle, 1993; DeBruin *et al.*, 1992; Ramanand *et al.*, 1993; Vogel, 1994; Suflita and Townsend, 1995; Adriaens and Vogel, 1995; Bradley and Chapelle, 1996; Gossett and Zinder, 1996; Spain, 1996). Table B.3.2 presents a partial list of microorganisms known to degrade anthropogenic organic compounds.

Although we now recognize that microorganisms are ubiquitous in drinking water aquifers, the study of the microbial ecology and physiology of the subsurface, below the rhizosphere, is still in its infancy. However, great progress has been made at least in identifying, if not fully understanding,

the numerous and diverse types of microbially-mediated contaminant transformations that can occur in the subsurface.

Chemotrophic organisms, such as humans and most microorganisms, obtain energy for growth and activity from physiologically coupling oxidation and reduction reactions and harvesting the chemical energy that is available. Under aerobic conditions (in the presence of molecular oxygen) humans and many bacteria couple the oxidation of organic compounds (food) to the reduction of oxygen (from the air). However in the absence of oxygen (anaerobic conditions), microorganisms may use other compounds as electron acceptors. Anaerobic microorganisms can obtain energy from a variety of electron donors such as natural organic carbon or many forms of anthropogenic carbon and electron acceptors such as nitrate, iron (III), sulfate, carbon dioxide, as well as many of the chlorinated solvents.

The introduction of oxidizable soluble organic contaminants into ground water initiates a series of complex responses by subsurface microorganisms. Field and laboratory research suggests that distinct communities defined by the dominant electron acceptor develop which are spatially and temporally separate. These communities are most likely ecologically defined by the flux of biologically available electron donors and acceptors. The biological processes of these communities are potentially useful as natural attenuation mechanisms, as the basis of new bioremediation technologies, and as indicators of the extent and severity of the release. As electron acceptors and nutrients are depleted by microbial activity during biodegradation of contaminants, the redox potential of contaminated aquifers decreases. This results in a succession of bacterial types adapted to specific redox regimes and electron acceptors. Metabolic byproducts of contaminant biodegradation also exert selective forces, either by presenting different carbon sources or by further modifying the physical and chemical environment of the aquifer. Like organic and inorganic colloids, microorganisms possess complex surface chemistry, and can themselves serve as mobile and immobile reactive sites for contaminants.

Under anaerobic conditions, most organic compounds are degraded by groups of interacting microorganisms referred to as a consortium. In the consortium, individual types of organisms carry out different specialized reactions which, when combined, can lead to the complete mineralization of a particular compound. The metabolic interaction between organisms can be complex and may be so tightly linked under a given set of conditions that stable consortia can be mistakenly identified as a single species. There seems to be several advantages to the consortial system, including: 1) This system allows for the creation of microenvironments where certain types of organisms can survive in otherwise hostile conditions; 2) Reactions that are thermodynamically unfavorable can be driven by favorable reactions when they are metabolically linked within the consortium; and, 3) This system takes advantage of the diverse metabolic capabilities of microorganisms by allowing for the formation and enrichment of associations that can utilize an introduced substrate faster than a single species could evolve a novel complex enzyme pathway to degrade the same compound.

It appears that subsurface microbial communities contain the metabolic diversity required to utilize a wide variety of organic contaminants as a primary growth substrate in the presence of electron acceptors such as oxygen. Some pollutants, especially the highly oxidized chlorinated hydrocarbons, are not amenable to use as a primary growth substrate. Instead, these compounds are used as electron acceptors in reactions that rely on another source of carbon as a primary substrate or are degraded fortuitously via cometabolism. Thus, biodegradation of organic compounds in ground water occurs via three mechanisms:

- Use of the organic compound as the primary growth substrate;
- Use of the organic compound as an electron acceptor; and
- Cometabolism.

The first two biodegradation mechanisms involve the microbial transfer of electrons from electron donors (primary growth substrate) to electron acceptors. This process can occur under aerobic or anaerobic conditions. Electron donors include natural organic material, fuel hydrocarbons, chlorobenzenes, and the less oxidized chlorinated ethenes and ethanes. Electron acceptors are elements or compounds that occur in relatively oxidized states. The most common naturally occurring electron acceptors in ground water include dissolved oxygen, nitrate, manganese (IV), iron (III), sulfate, and carbon dioxide. In addition, the more oxidized chlorinated solvents such as PCE, TCE, DCE, TCA, DCA, and polychlorinated benzenes can act as electron acceptors under favorable conditions. Under aerobic conditions, dissolved oxygen is used as the terminal electron acceptor during aerobic respiration. Under anaerobic conditions, the electron acceptors listed above are used during denitrification, manganese (IV) reduction, iron (III) reduction, sulfate reduction, methanogenesis, or reductive dechlorination. Chapelle (1993) and Atlas (1988) discuss terminal electron accepting processes in detail.

The third biodegradation mechanism is cometabolism. During cometabolism the compound being degraded does not benefit the organism. Instead, degradation is brought about by a fortuitous reaction wherein an enzyme produced during an unrelated reaction degrades the organic compound.

As discussed in sections B.3.2, B.3.3, and B.3.4, biodegradation causes measurable changes in ground-water chemistry. Table B.3.3 summarizes these trends. During aerobic respiration, oxygen is reduced to water, and dissolved oxygen concentrations decrease. In anaerobic systems where nitrate is the electron acceptor, the nitrate is reduced to NO_2^- , N_2O , NO , NH_4^+ , or N_2 via denitrification or dissimilatory nitrate reduction, nitrate concentrations decrease. In anaerobic systems where iron (III) is the electron acceptor, it is reduced to iron (II) via iron (III) reduction, and iron (II) concentrations increase. In anaerobic systems where sulfate is the electron acceptor, it is reduced to H_2S via sulfate reduction, and sulfate concentrations decrease. During aerobic respiration, denitrification, iron (III) reduction, and sulfate reduction, total alkalinity will increase. In anaerobic systems where CO_2 is used as an electron acceptor, it is reduced by methanogenic bacteria during methanogenesis, and CH_4 is produced. In anaerobic systems where contaminants are being used as electron acceptors, they are reduced to less chlorinated daughter products; in such a system, parent compound concentrations will decrease and daughter product concentrations will increase at first and then decrease as the daughter product is used as an electron acceptor or is oxidized.

As each subsequent electron acceptor is utilized, the ground water becomes more reducing and the redox potential of the water decreases. Figure B.3.3 shows the typical ORP conditions for ground water when different electron acceptors are used. The main force driving this change in ORP is microbially mediated oxidation-reduction reactions. ORP can be used as a crude indicator of which oxidation-reduction reactions may be operating at a site. The ORP determined in the field using an electrode is termed Eh. Eh can be expressed as pE, which is the hypothetical measure of the electron activity associated with a specific Eh. High pE means that the solution or redox couple has a relatively high oxidizing potential.

B.3.2 BIODEGRADATION OF ORGANIC COMPOUNDS VIA USE AS A PRIMARY GROWTH SUBSTRATE

Many organic compounds including natural organic carbon, fuel hydrocarbons, and the less oxidized chlorinated compounds such as DCE, 1,2-DCA, chlorobenzene, or vinyl chloride can be used as primary growth substrates (electron donor) for microbial metabolism. The following sections describe biodegradation of organic compounds through use as a primary substrate under both aerobic and anaerobic conditions.

B.3.2.1 Aerobic Biodegradation of Primary Substrates

Biodegradation of organic compounds is often an aerobic process that occurs when indigenous populations of microorganisms are supplied with the oxygen and nutrients necessary to utilize

Table B.3.3 Trends in Contaminant, Electron Acceptor, Metabolic By-product and Total Alkalinity Concentrations During Biodegradation

Analyte	Terminal Electron Accepting Process	Trend in Analyte Concentration During Biodegradation
Fuel Hydrocarbons	Aerobic Respiration, Denitrification, Manganese (IV) Reduction, Iron (III) Reduction, Methanogenesis	Decreases
Highly Chlorinated Solvents and Daughter Products	Reductive Dechlorination	Parent Compound Concentration Decreases, Daughter Products Increase Initially and Then May Decrease
Lightly Chlorinated Solvents	Aerobic Respiration, Denitrification, Manganese (IV) Reduction, Iron (III) Reduction (Direct Oxidation)	Compound Concentration Decreases
Dissolved Oxygen	Aerobic Respiration	Decreases
Nitrate	Denitrification	Decreases
Manganese (II)	Manganese (IV) Reduction	Increases
Iron (II)	Iron (III) Reduction	Increases
Sulfate	Sulfate Reduction	Decreases
Methane	Methanogenesis	Increases
Chloride	Reductive Dechlorination or Direct Oxidation of Chlorinated Compound	Increases
ORP	Aerobic Respiration, Denitrification, Manganese (IV) Reduction, Iron (III) Reduction, Methanogenesis	Decreases
Alkalinity	Aerobic Respiration, Denitrification, Iron (III) Reduction, and Sulfate Reduction	Increases

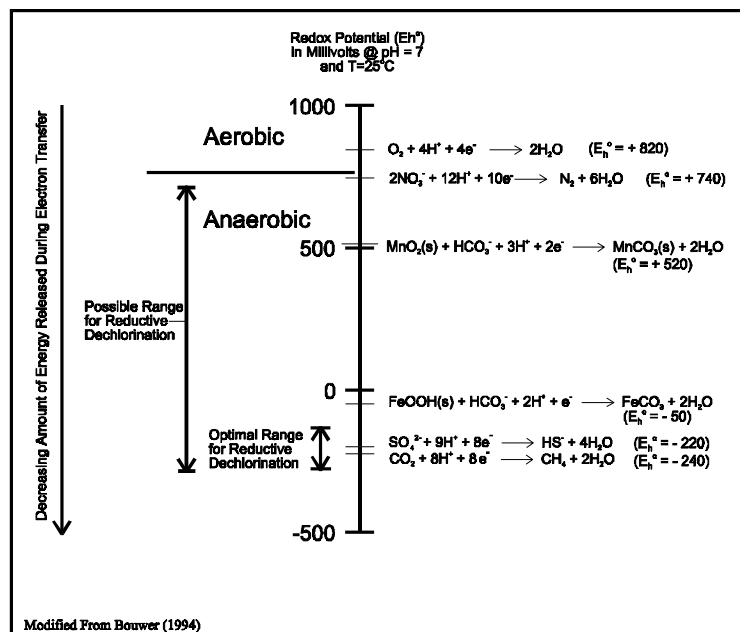

Figure B.3.3 Oxidation-reduction potentials for various oxidation-reduction reactions.

organic carbon as an energy source. The biodegradation of fuel hydrocarbons occurs rapidly under aerobic conditions and is discussed in Wiedemeier *et al.* (1995a). Some pollutants, especially the highly oxidized chlorinated hydrocarbons (i.e., those containing more chlorine substituents), are biologically recalcitrant under aerobic conditions. However, some of the less chlorinated ethenes and ethanes such as DCE, VC, and 1,2-DCA, and many of the chlorinated benzenes can be utilized as primary substrates and oxidized under aerobic conditions. During aerobic biodegradation (oxidation) of chlorinated solvents, the facilitating microorganism obtains energy and organic carbon from the degraded solvent.

Of the chlorinated ethenes, vinyl chloride is the most susceptible to aerobic biodegradation, and PCE the least. Of the chlorinated ethanes, 1,2-DCA is the most susceptible to aerobic biodegradation (chloroethane is more likely to abiotically hydrolyze to ethanol), while TCA, tetrachloroethane, and hexachloroethane are less so. Chlorinated benzenes with up to 4 chlorine atoms (i.e., chlorobenzene, dichlorobenzene, trichlorobenzene, and tetrachlorobenzene) also have been shown to be readily biodegradable under aerobic conditions (Spain, 1996). Pentachlorobenzene and hexachlorobenzene are unlikely to be oxidized by microbial activity.

B.3.2.1.1 Aerobic Oxidation of Petroleum Hydrocarbons

Fuel hydrocarbons are rapidly biodegraded when they are utilized as the primary electron donor for microbial metabolism under aerobic conditions. Biodegradation of fuel hydrocarbons occurs naturally when sufficient oxygen (or other electron acceptors) and nutrients are available in the ground water. The rate of natural biodegradation is generally limited by the lack of oxygen or other electron acceptors rather than by the lack of nutrients such as nitrogen or phosphorus. The rate of natural aerobic biodegradation in unsaturated soil and shallow aquifers is largely dependent upon the rate at which oxygen enters the contaminated media. Biodegradation of fuel hydrocarbons is discussed by Wiedemeier *et al.* (1995a).

B.3.2.1.2 Aerobic Oxidation of Chlorinated Ethenes

In general, the highly chlorinated ethenes (e.g., PCE and TCE) are not likely to serve as electron donors or substrates for microbial degradation reactions. This is because the highly chlorinated compounds tend to be much more oxidized than many compounds present in a natural ground-water system. Several microbes or microbial enrichments have been shown to be capable of TCE oxidation (Fogel *et al.*, 1986; Nelson *et al.*, 1986; Little *et al.*, 1988); however, as noted by Vogel (1994), no strong evidence for the oxidation of highly chlorinated solvents has been derived from actual hazardous waste sites.

Using microcosms from two different sites with no prior history of exposure to DCE, Klier *et al.* (1998) show that all three isomers of DCE (i.e., 1,1-DCE, I-1,2-DCE, and *trans*-1,2-DCE) can be biodegraded in aerobic systems. In these experiments, it was observed that *cis*-1,2-DCE degraded more rapidly than the other isomers. Hartmans *et al.* (1985) and Hartmans and de Bont (1992) show that vinyl chloride can be used as a primary substrate under aerobic conditions, with vinyl chloride apparently being directly mineralized to carbon dioxide and water. This has also been reported by Davis and Carpenter (1990). Aerobic biodegradation is rapid relative to other mechanisms of vinyl chloride degradation, especially reductive dehalogenation.

B.3.2.1.3 Aerobic Oxidation of Chlorinated Ethanes

Of the chlorinated ethanes, only 1,2-dichloroethane has been shown to be aerobically mineralized/oxidized. Stucki *et al.* (1983) and Janssen *et al.* (1985) show that 1,2-DCA can be used as a primary substrate under aerobic conditions. In this case, the bacteria transform 1,2-DCA to chloroethanol, which is then mineralized to carbon dioxide. Evidence of oxidation of chloroethane is scant, however, it appears to rapidly degrade via abiotic mechanisms (hydrolysis) and is thus less likely to undergo biodegradation.

B.3.2.1.4 Aerobic Oxidation of Chlorobenzenes

Chlorobenzene and polychlorinated benzenes (up to and including tetrachlorobenzene) have been shown to be biodegradable under aerobic conditions. Several studies have shown that bacteria are able to utilize chlorobenzene (Reineke and Knackmuss, 1984), 1,4-DCB (Reineke and Knackmuss, 1984; Schraa *et al.*, 1986; Spain and Nishino, 1987), 1,3-DCB (de Bont *et al.*, 1986), 1,2-DCB (Haigler *et al.*, 1988), 1,2,4-TCB (van der Meer *et al.*, 1987; Sander *et al.*, 1991), and 1,2,4,5-TeCB (Sander *et al.*, 1991) as primary growth substrates in aerobic systems. Nishino *et al.* (1994) note that aerobic bacteria able to grow on chlorobenzene have been detected at a variety of chlorobenzene-contaminated sites, but not at uncontaminated sites. Spain (1996) notes that this provides strong evidence that the bacteria are selected for their ability to derive carbon and energy from chlorobenzene degradation *in situ*.

The pathways for all of these reactions are similar, and are also similar to that of benzene (Chapelle, 1993; Spain, 1996). In general, the aerobic biodegradation involves hydroxylation of the chlorinated benzene to a chlorocatechol, followed by *ortho* cleavage of the benzene ring. This produces a muconic acid, which is dechlorinated, and the non-chlorinated intermediates are then metabolized. The only significant difference between this process and aerobic benzene degradation is the elimination of chlorine at some point in the pathway (Chapelle, 1993).

B.3.2.2 Anaerobic Biodegradation of Primary Substrates

Rapid depletion of dissolved oxygen caused by microbial respiration results in the establishment of anaerobic conditions in areas with high organic carbon concentrations. Certain requirements must be met in order for anaerobic (anoxic) bacteria to degrade organic compounds, including: absence of dissolved oxygen; availability of carbon sources (natural or anthropogenic), electron acceptors, and essential nutrients; and proper ranges of pH, temperature, salinity, and redox potential. When oxygen is absent, nitrate, manganese (IV), iron (III), sulfate, and carbon dioxide can serve as terminal electron acceptors during oxidation of organic carbon. While there is a large body of evidence for anaerobic mineralization (oxidation) of fuel hydrocarbons, there is very little evidence of such transformations involving chlorinated compounds.

B.3.2.2.1 Anaerobic Oxidation of Petroleum Hydrocarbons

Biodegradation of fuel hydrocarbons will occur under anaerobic conditions in most, if not all, ground-water environments via denitrification, manganese (IV) reduction, iron (III) reduction, sulfate reduction, and methanogenesis. Biodegradation of fuel hydrocarbons is discussed by Wiedemeier *et al.* (1995a), and many primary references are cited therein.

B.3.2.2.2 Anaerobic Oxidation of Chlorinated Ethenes

In general, due to the oxidized nature of polychlorinated ethenes, they are unlikely to undergo oxidation in groundwater systems. However, Bradley and Chapelle (1996) show that vinyl chloride (with only one chlorine substituent) can be directly oxidized to carbon dioxide and water via iron (III) reduction. Reduction of vinyl chloride concentrations in microcosms amended with iron (III)-EDTA closely matched the production of carbon dioxide. Slight mineralization was also noted in unamended microcosms. The rate of this reaction apparently depends on the bioavailability of the iron (III). At this time, it is not known if other workers have demonstrated other anaerobic mineralization reactions involving chlorinated ethenes.

B.3.2.2.3 Anaerobic Oxidation of Chlorinated Ethanes

During preparation of this protocol, no evidence of anaerobic oxidation of chlorinated ethanes was found; this does not necessarily indicate that such reactions have not been described. However, the lack of discussion of such transformations in surveys of chlorinated hydrocarbon biodegradation (e.g., Vogel *et al.*, 1987; McCarty and Semprini, 1994; Vogel, 1994; Adriaens and Vogel, 1995; Spain, 1996) suggests that there has indeed been little, if any, work on this subject.

B.3.2.2.4 Anaerobic Oxidation of Chlorobenzenes

While aerobic mineralization of chlorobenzenes is similar to that of benzene, similar activity under anaerobic conditions has not been documented. As discussed above, there is little, if any, discussion of this topic in the literature.

B.3.3 BIODEGRADATION OF ORGANIC COMPOUNDS VIA USE AS AN ELECTRON ACCEPTOR (REDUCTIVE DECHLORINATION)

Bouwer *et al.* (1981) were the first to show that halogenated aliphatic hydrocarbons could be biologically transformed under anaerobic conditions in the subsurface environment. Since that time, numerous investigators have shown that chlorinated compounds can degrade via reductive dechlorination under anaerobic conditions. Anaerobically, biodegradation of chlorinated solvents most often proceeds through a process called reductive dechlorination. During this process, the halogenated hydrocarbon is used as an electron acceptor, not as a source of carbon, and a halogen atom is removed and replaced with a hydrogen atom. As an example, *Dehalobacter restrictus* was shown by Holliger *et al.*, (1993) to use tetrachloroethene as an electron acceptor during reductive dechlorination to produce *cis*-1,2-dichloroethene. Because chlorinated compounds are used as electron acceptors during reductive dechlorination, there must be an appropriate source of carbon for microbial growth in order for reductive dehalogenation to occur (Baek and Jaffe, 1989; Freedman and Gossett, 1989; Fathepure and Boyd, 1988; Bouwer, 1994). Potential carbon sources can include low molecular weight organic compounds (lactate, acetate, methanol, glucose, etc.), fuel hydrocarbons, byproducts of fuel degradation (e.g., volatile fatty acids), or naturally occurring organic matter.

In some situations, reductive dechlorination may be a cometabolic process, in that the reaction is incidental to normal metabolic functions and the organisms derive no benefit from the reaction. Such cometabolism typically results in slow, incomplete dechlorination (Gantzer and Wackett, 1991; Gossett and Zinder, 1996). More important, recent studies are discovering direct dechlorinators (typically isolated from contaminated subsurface environments or treatment systems) that use chlorinated ethenes as electron acceptors in reactions that provide growth and energy (e.g., Holliger *et al.*, 1992; Holliger *et al.*, 1993; Holliger and Schumacher, 1994; Neumann *et al.*, 1994; Krumholz, 1995; Maymo-Gatell *et al.*, 1995; Sharma and McCarty, 1996; Gerritse *et al.*, 1996). This process has been termed both *halorespiration* and *dehalorespiration*.

Biotic transformations of chlorinated solvents under anaerobic conditions generally are reductions that involve either hydrogenolysis or dihaloelimination (McCarty and Semprini, 1994). Hydrogenolysis occurs when a chlorine atom is replaced with hydrogen. Dihaloelimination occurs when two adjacent chlorine atoms are removed and a double bond is formed between the respective carbon atoms. The most important process for the natural biodegradation of the more highly chlorinated solvents is reductive dechlorination (hydrogenolysis).

Higher ratios of chlorine to carbon represent higher oxidation levels; highly chlorinated compounds are more oxidized than lesser chlorinated compounds and thus are less susceptible to oxidation. Thus, highly chlorinated compounds such as PCE, TCE, TCA, or HCB are more likely to undergo reductive reactions than oxidative reactions. During these reductive reactions, electrons are transferred to the chlorinated compound, and a chlorine atom is replaced with a hydrogen atom. As an example, consider the reductive dechlorination of PCE to TCE and then TCE to DCE, and finally DCE to vinyl chloride. Because of the relatively low oxidation state of VC, this compound more commonly undergoes aerobic biodegradation as a primary substrate than reductive dechlorination.

Reductive dechlorination processes result in the formation of intermediates which are more reduced than the parent compound. These intermediates are often more susceptible to oxidative bacterial metabolism than to further reductive anaerobic processes. Actual mechanisms of reductive dehalogenation are still unclear, and in some cases may be a form of cometabolism (Gantzer and Wackett, 1991; Adriaens and Vogel, 1995; Wackett, 1995). In addition, other factors that will influ-

ence the process include the type of electron donor and the presence of competing electron acceptors (Adriaens and Vogel, 1995; Suflita and Townsend, 1995), temperature, and substrate availability.

Recent evidence suggests that dechlorination is dependent upon the supply of hydrogen (H_2), which acts as the electron donor in many such reactions (Gossett and Zinder, 1996; Smatlak *et al.*, 1996). The hydrogen is produced as a result of the microbial degradation of a primary substrate (e.g., lactate, acetate, butyrate, ethanol, BTEX, or other such compounds). Bacteria that facilitate dechlorination compete with sulfate-reducers and methanogens for the H_2 produced in such a system. When degradation of the original substrate/electron donor rapidly yields high concentrations of H_2 , the sulfate-reducers and methanogens appear to be favored over the dechlorinators. Conversely, when substrate degradation produces a steady supply of H_2 at low concentrations, the dechlorinators are favored (Gossett and Zinder, 1996; Smatlak *et al.*, 1996). Complete dechlorination is thus apparently favored when a steady, low-concentration supply of H_2 is produced through microbial degradation of substrates such as proprionate or benzoate (and, by extension from benzoate, the BTEX compounds) (Gossett and Zinder, 1996). Therefore, the type of substrate/electron donor can also play a role in how thoroughly a natural system is able to dechlorinate solvents.

One or more of the following generally is observed at a site where reductive dechlorination of alkenes is ongoing:

- 1) Ethene is being produced (even low concentrations are indicative of biodegradation);
- 2) Methane is being produced;
- 3) Iron II is being produced;
- 4) Hydrogen concentrations are between 1-4 nM; and
- 5) Dissolved oxygen concentrations are low.

B.3.3.1 Reductive Dechlorination of Chlorinated Ethenes

PCE and TCE have been shown to undergo reductive dechlorination in a variety of anaerobic systems from different environments, with various electron donors/carbon sources (Table B.3.4) (Wilson, 1988; Sewell *et al.*, 1991; Roberts *et al.*, 1982). This is particularly true if the subsurface also contains other anthropogenic or native organic compounds that can serve as electron donors and whose utilization by subsurface bacteria will deplete any available oxygen. In general, reductive dechlorination of chlorinated ethenes occurs by sequential dechlorination from PCE to TCE to DCE to VC to ethene. Depending upon environmental conditions, this sequence may be interrupted, with other processes then acting upon the products. With sufficient quantities or appropriate types of electron donors (e.g., slow but steady H_2 -production), the final end-product of anaerobic reductive dehalogenation can be ethene (Freedman and Gossett, 1989). Reductive dehalogenation of chlorinated solvent compounds is associated with the accumulation of daughter products and an increase in chloride.

Studies have shown that PCE and TCE can be anaerobically reduced to either 1,1-DCE, *cis*-1,2-DCE, or *trans*-1,2-DCE, all of which can be further transformed to vinyl chloride (Miller and Guengerich, 1982; Wilson and Wilson, 1985; Mayer *et al.*, 1988; Nelson, *et al.*, 1986; Henson *et al.*, 1989; Tsien *et al.*, 1989; Henry, 1991; McCarty, 1994; Wilson *et al.*, 1994). During reductive dehalogenation, all three isomers of DCE can theoretically be produced; however, Bouwer (1994) reports that *cis*-1,2-DCE is a more common intermediate than *trans*-1,2-DCE and that 1,1-DCE is the least prevalent intermediate of the three DCE isomers. Vinyl chloride produced from dehalogenation of DCE may be subsequently reduced to innocuous products such as ethane or carbon dioxide. The removal of vinyl chloride occurs more readily under aerobic conditions, such as those encountered at the edge of the plume. Vinyl chloride may also be used as a primary substrate by aerobic organisms, as previously discussed.

Table B.3.4 Sources, Donors, Acceptors, and Products of Reductive Dechlorinating Laboratory Systems

Reference	Source	Donor	Acceptor-Product
Bouwer & McCarty, 1983	Digester	Organic Material	PCE-TCE
Vogel & McCarty, 1985	Bioreactor	Acetate	PCE-VC, CO ₂
Kleopfer <i>et al.</i> , 1985	Soil	Soybean Meal	TCE-DCE
Barrio-Lage <i>et al.</i> , 1987	Swamp Muck	Organic Material	PCE-VC
	Soil	Methanol (?)	PCE-VC
Fathpure <i>et al.</i> , 1987	Methanosarcina	Methanol	PCE-TCE
	DCB-1	3CB ^a , Pyruvate, RF ^b	PCE-TCE
Baek & Jaffe, 1989	Digester	Formate	TCE-VC, CA ^c
		Methanol	TCE-VC, CA
Freedman & Gossett, 1989	Digester	Methanol	PCE-VC, Ethene
		Glucose	PCE-VC, Ethene
		H ₂	PCE-VC, Ethene
		Formate	PCE-VC, Ethene
		Acetate	PCE-VC, Ethene
Scholz-Muramatsu <i>et al.</i> , 1990	Bioreactor	Benzoate	PCE-DCE
Gibson & Sewell, 1990	Aquifer	VFA ^d	PCE-DCE
Sewell & Gibson, 1990	Aquifer	Toluene	PCE-DCE
Sewell <i>et al.</i> , 1991	Aquifer	VFA	PCE-DCE
	Landfill	VFA	PCE-VC
Lyon <i>et al.</i> , 1995	Aquifer	Native Organic Matter	PCE-DCE

a 3-Chlorobenzoate
b Rumen Fluid
c Chloroethane
d Volatile Fatty Acid

B.3.3.2 Reductive Dechlorination of Chlorinated Ethanes

As with the ethenes, chlorinated ethanes will also undergo reductive dehalogenation in the subsurface via use as electron acceptors. Dechlorination of TCA has been described by Vogel and McCarty (1987) and Cox *et al.* (1995), but this pathway is complicated by the abiotic reactions that can affect TCA and its byproducts (Vogel, 1994).

B.3.3.3 Reductive Dechlorination of Chlorobenzenes

For the highly chlorinated benzenes (e.g., hexachlorobenzene and pentachlorobenzene, as well as tetrachlorobenzene, and trichlorobenzene), reductive dechlorination is the most likely biodegradation mechanism (Holliger *et al.*, 1992; Ramanand *et al.*, 1993; Suflita and Townsend, 1995). As discussed by Suflita and Townsend (1995), reductive dehalogenation of aromatic compounds has been observed in a variety of anaerobic habitats, including aquifer materials, marine and freshwater sediments, sewage sludges, and soil samples; however, isolation of specific microbes capable of these reactions has been difficult. As with the chlorinated ethenes and ethanes, the chlorobenzenes are most likely acting as electron acceptors as other sources of carbon and energy are being utilized by microbes or microbial consortia (Suflita and Townsend, 1995). Evidence has been presented suggesting that oxidation of hydrogen using halogenated aromatics as electron acceptors may yield more energy than if more commonly available electron acceptors were used (Dolfing and Harrison, 1992).

As discussed previously, the actual mechanisms of reductive dehalogenation are not well understood. Further, reductive dehalogenation of chlorinated benzenes has not been as well-documented as for other chlorinated solvents. However, reductive dechlorination of chlorobenzenes has been documented more frequently in the past several years (e.g., Bosma *et al.*, 1988; Fathepure *et al.*, 1988; Fathepure and Vogel, 1991; Holliger *et al.*, 1992; Ramanand *et al.*, 1993). As with other chlorinated solvents, the reductive dehalogenation of chlorobenzenes is affected by the degree of chlorination of the compound. The more chlorinated aromatic compounds are typically more amenable to this reaction (Suflita and Townsend, 1995; Adriaens and Vogel, 1995), but as they are dechlorinated, the daughter products will become more resistant to further dehalogenation reactions (Fathepure *et al.*, 1988; Bosma *et al.*, 1988; Holliger *et al.*, 1992). The reductive dechlorination of chlorobenzenes is analogous to reactions involving chlorinated ethenes and ethanes in that such degradation will make them more amenable to aerobic biodegradation (Schraa, *et al.*, 1986; Spain and Nishino, 1987; Ramanand *et al.*, 1993).

B.3.4 BIODEGRADATION OF ORGANIC COMPOUNDS VIA COMETABOLISM

When a chlorinated solvent is biodegraded through cometabolism, it serves as neither an electron acceptor nor a primary substrate in a biologically mediated redox reaction. Instead, the degradation of the compound is catalyzed by an enzyme cofactor that is fortuitously produced by organisms for other purposes. The best-documented cometabolism reactions involve catabolic oxygenases that catalyze the initial step in oxidation of their respective primary or growth substrate (BTEX or other organic compounds). These oxygenases are typically nonspecific and, therefore, fortuitously initiate oxidation of a variety of compounds, including many of the CAHs (McCarty and Semprini, 1994). The organism receives no known benefit from the degradation of the chlorinated solvent; in some cases the cometabolic degradation of the solvent may, in fact, be harmful to the microorganism responsible for the production of the enzyme or cofactor (McCarty and Semprini, 1994). Chlorinated solvents are usually only partially transformed during cometabolic processes, with additional biotic or abiotic degradation generally required to complete the transformation (McCarty and Semprini, 1994).

Cometabolism is best documented for CAHs in aerobic environments; evidence of cometabolism of chlorobenzenes is scant, as is clear evidence of anaerobic cometabolism. In an

aerobic environment, many chlorinated organic compounds can only be degraded via cometabolism. It has been reported that under aerobic conditions chlorinated ethenes, with the exception of PCE, are susceptible to cometabolic degradation (Murray and Richardson, 1993; Vogel, 1994; McCarty and Semprini, 1994; Adriaens and Vogel, 1995). Vogel (1994) further elaborates that the oxidation rate increases as the degree of chlorination decreases. Aerobic cometabolism of ethenes may be characterized by a loss of contaminant mass, the presence of intermediate degradation products (e.g., chlorinated oxides, aldehydes, ethanols, and epoxides), and the presence of other products such as chloride, carbon dioxide, carbon monoxide, and a variety of organic acids (Miller and Guengerich, 1982; McCarty and Semprini, 1994).

The lack of clear evidence for anaerobic cometabolism does not necessarily imply that such transformations do not occur; in some cases, reductive dechlorination may be a result of cometabolism (e.g., Gantzer and Wackett, 1991), depending upon the relationship between the microbes, substrates, contaminants, and other electron acceptors. However, as with aerobic cometabolism, anaerobic cometabolism will be slow relative to dehalorespiration and might not be distinguishable at the field scale (Gossett and Zinder, 1996).

Several groups of aerobic bacteria currently are recognized as being capable of transforming TCE and other CAHs via cometabolism; these groups include:

- Methane Oxidizers (Methanotrophs) (Fogel *et al.*, 1986; Little *et al.*, 1988, Mayer *et al.*, 1988; Oldenhuis *et al.*, 1989; Tsien *et al.*, 1989; Henry and Grbic-Galic, 1990; Alvarez-Cohen and McCarty, 1991a,b; Henry and Grbic-Galic, 1991a,b; Lanzarone and McCarty, 1990; Oldenhuis *et al.*, 1991);
- Propane Oxidizers (Wackett *et al.*, 1989);
- Ethene Oxidizers (Henry, 1991);
- Toluene, Phenol, or Cresol Oxidizers (Nelson *et al.*, 1986, 1987, 1988; Wackett and Gibson, 1988; Folsom *et al.*, 1990; Harker and Kim, 1990);
- Ammonia Oxidizers (Arciero *et al.*, 1989; Vannelli *et al.*, 1990);
- Isoprene Oxidizers (Ewers *et al.*, 1991); and
- Vinyl Chloride Oxidizers (Hartmans and de Bont, 1992).

These bacteria all have catabolic oxygenases that catalyze the initial step in oxidation of their respective primary or growth substrates and have the potential for initiating the oxidation of CAHs.

Cometabolism is not nearly as important a degradation mechanism for chlorinated solvents in the saturated zone as reductive dehalogenation. Due to the need for a substrate that may be present in limited concentrations, as well as the fortuitous nature of the reactions, rates of cometabolism are often slow enough that this process may not be detectable unless the system is stimulated with additional substrate mass. For a discussion of this topic, see McCarty and Semprini (1994) or Wackett (1995).

B.3.5 THERMODYNAMIC CONSIDERATIONS

Electron transfer results in oxidation of the electron donor and reduction of the electron acceptor and the production of usable energy. The energy produced by these reactions is quantified by the Gibbs free energy of the reaction (G_r) which is given by:

$$\Delta G_r^\circ = \sum \Delta G_{f,products}^\circ - \sum \Delta G_{f,reactants}^\circ \quad \text{eq. B.3.1}$$

Where:

ΔG_r° = Gibbs Free Energy of the Reaction at Standard State

$\Delta G_{f,products}^\circ$ = Gibbs Free Energy of Formation for Products at Standard State

$\Delta G_{f,reactants}^\circ$ = Gibbs Free Energy of Formation for the Reactants at Standard State

The G_r defines the maximum useful energy change for a chemical reaction at a constant temperature and pressure. Table B.3.5 presents select electron acceptor and electron donor half-cell reactions and the calculated G_r values. Table B.3.6 gives the Gibbs free energy of formation (G_f) for species used in these half-cell reactions. Table B.3.7 presents coupled oxidation-reduction reactions. In general, those reactions that yield the most energy tend to take precedence over less energy-yielding reactions. However, the calculated energy yield of processes involving anthropogenic organic compounds may not be reflected in the true energy yield of the metabolic process. Figure B.3.4 illustrates the expected sequence of microbially mediated redox reactions based on G_r . There is sufficient energy in the reaction of fuel hydrocarbons with chlorinated solvents to allow their use by microorganisms as physiological electron acceptors.

Table B.3.5 Electron Donor and Electron Acceptor Half-Cell Reactions

HALF-CELL REACTIONS	ΔG° , (kcal/ equiv)*	ΔG° , (kJ/ equiv)*	E° (V)	Eh (V)	pe	Conditions for Eh and pe §
ELECTRON-ACCEPTOR (REDUCTION) HALF CELL REACTIONS						
$5e^- + 6H^+ + NO_3^- \Rightarrow 0.5N_2 + 3H_2O$ <i>Denitrification</i>	-28.7	-120.	+1.24	+0.708	+12.0	pH = 7 $\Sigma[N]=10^{-3}$
$4e^- + 4H^+ + O_2 \Rightarrow 2H_2O$ <i>Aerobic Respiration</i>	-28.3	-119.	+1.23	+0.805	+13.6	pH = 7 $P_{O_2}=0.21$ atm
$2e^- + 4H^+ + MnO_2 \Rightarrow Mn^{2+} + 2H_2O$ <i>Pyrolusite Dissolution/Reduction</i>	-28.3	-119	+1.23	+1.169	+19.8	pH = 7 $\Sigma[Mn]=10^{-5}$
$CO_2 + e^- + H^+ + MnOOH \Rightarrow MnCO_3 + H_2O$ <i>Manganite Carbonation/Reduction</i>	-23.1	-96.8	+1.00	+0.408	+6.90	pH = 8 $P_{CO_2}=10^{-2}$
$e^- + H^+ + MnO_2 \Rightarrow MnOOH$ <i>Pyrolusite Hydrolysis/Reduction</i>	-22.1	-92.5	+0.959	+0.545	+9.21	pH = 7
$e^- + 3H^+ + Fe(OH)_3,amph. \Rightarrow Fe^{2+} + 3H_2O$ <i>Amorphous "Goethite" Dissolution/Reduction</i>	-21.5	-89.9	+0.932	+0.163	+2.75	pH = 6 $\Sigma[Fe]=10^{-5}$
$8e^- + 10H^+ + NO_3^- \Rightarrow NH_4^+ + 3H_2O$ <i>Nitrate Reduction</i>	-20.3	-84.9	+0.879	+0.362	+6.12	pH = 7
$2e^- + 2H^+ + NO_3^- \Rightarrow NO_2^- + H_2O$ <i>Nitrate Reduction</i>	-18.9	-78.9	+0.819	+0.404	+6.82	pH = 7
$e^- + 3H^+ + FeOOH \Rightarrow Fe^{2+} + 2H_2O$ <i>"Ferric oxyhydroxide" Dissolution/Reduction</i>	-15.0	-62.9	+0.652	-0.118	-1.99	pH = 6 $\Sigma[Fe]=10^{-5}$
$e^- + 3H^+ + Fe(OH)_3,cline. \Rightarrow Fe^{2+} + 3H_2O$ <i>Crystallized "Goethite" Dissolution/Reduction</i>	-11.8	-49.2	+0.510	-0.259	-4.38	pH = 6 $\Sigma[Fe]=10^{-5}$
$e^- + H^+ + CO_{2,g} + Fe(OH)_3,amph. \Rightarrow FeCO_3 + 2H_2O$ <i>Amorphous "Goethite" Carbonation/Reduction</i>	-11.0	-46.2	+0.479	-0.113	-1.90	pH = 8 $P_{CO_2}=10^{-2}$ atm
$8e^- + 9H^+ + SO_4^{2-} \Rightarrow HS^- + 4H_2O$ <i>Sulfate Reduction</i>	-5.74	-24.0	+0.249	-0.278	-4.70	pH = 8
$8e^- + 10H^+ + SO_4^{2-} \Rightarrow H_2S^0 + 4H_2O$ <i>Sulfate Reduction</i>	-6.93	-28.9	+0.301	-0.143	-2.42	pH = 6
$8e^- + 8H^+ + CO_{2,g} \Rightarrow CH_{4,g} + 2H_2O$ <i>Methanogenesis</i>	-3.91	-16.4	+0.169	-0.259	-4.39	pH = 7 $P_{CO_2}=10^{-2}$ $P_{CH_4}=10^0$
$C_2Cl_4 + H^+ + 2e^- \Rightarrow C_2HCl_3 + Cl^-$ <i>PCE Reductive Dechlorination</i>	-14.79	-61.8	+0.641	+0.552	+9.33	pH = 7 $[Cl^-]=10^{-4}$
$C_2HCl_3 + H^+ + 2e^- \Rightarrow C_2H_2Cl_2 + Cl^-$ <i>TCE Reductive Dechlorination</i>	-14.50	-60.6	+0.628	+0.539	+9.12	pH = 7 $[Cl^-]=10^{-4}$
$C_2H_2Cl_2 + H^+ + 2e^- \Rightarrow C_2H_3Cl + Cl^-$ <i>c-DCE Reductive Dechlorination</i>	-12.12	-50.7	+0.525	+0.436	+7.38	pH = 7 $[Cl^-]=10^{-4}$
$C_2H_3Cl + H^+ + 2e^- \Rightarrow C_2H_4 + Cl^-$ <i>VC Reductive Dechlorination</i>	-13.75	-57.5	+0.596	+0.507	+8.57	pH = 7 $[Cl^-]=10^{-4}$
$C_2H_2Cl_4 + H^+ + 2e^- \Rightarrow C_2H_3Cl_3 + Cl^-$ <i>PCA Reductive Dechlorination</i>	-13.59	-56.8	+0.589	+0.500	+8.45	pH = 7 $[Cl^-]=10^{-4}$
$C_2H_3Cl_3 + H^+ + 2e^- \Rightarrow C_2H_4Cl_2 + Cl^-$ <i>TCA Reductive Dechlorination</i>	-15.26	-63.8	+0.661	+0.572	+9.67	pH = 7 $[Cl^-]=10^{-4}$
$C_2H_4Cl_2 + H^+ + 2e^- \Rightarrow C_2H_5Cl + Cl^-$ <i>DCA Reductive Dechlorination</i>	-14.08	-58.9	+0.610	+0.521	+8.81	pH = 7 $[Cl^-]=10^{-4}$
$C_6Cl_6 + H^+ + 2e^- \Rightarrow C_6HCl_5 + Cl^-$ <i>Hexachlorobenzene Reductive Dechlorination</i>	-14.36	-60.0	+0.622	+0.533	+9.01	pH = 7 $[Cl^-]=10^{-4}$
$C_6HCl_5 + H^+ + 2e^- \Rightarrow C_6H_2Cl_4 + Cl^-$ <i>Pentachlorobenzene Reductive Dechlorination</i>	-14.64	-61.2	+0.634	+0.545	+9.22	pH = 7 $[Cl^-]=10^{-4}$
$C_6H_2Cl_4 + H^+ + 2e^- \Rightarrow C_6H_3Cl_3 + Cl^-$ <i>Tetrachlorobenzene Reductive Dechlorination</i>	-13.66	-57.1	+0.592	+0.503	+8.50	pH = 7 $[Cl^-]=10^{-4}$
$C_6H_3Cl_3 + H^+ + 2e^- \Rightarrow C_6H_4Cl_2 + Cl^-$ <i>Trichlorobenzene Reductive Dechlorination</i>	-13.20	-55.2	+0.572	+0.483	+8.17	pH = 7 $[Cl^-]=10^{-4}$

Table B.3.5 Continued.

HALF-CELL REACTIONS	ΔG_r° (kcal/ equiv)*	ΔG_r° (kJ/ equiv)*	E° (V)	Eh (V)	pe	Conditions for Eh and pe §
ELECTRON-DONOR (OXIDATION) HALF CELL REACTIONS						
$12H_2O + C_6H_6 \Rightarrow 6CO_2 + 30H^+ + 30e^-$ <i>Benzene Oxidation</i>	+2.83	+11.8	-0.122	+0.316	+5.34	pH = 7 $P_{CO_2} = 10^{-2}$
$14H_2O + C_6H_5CH_3 \Rightarrow 7CO_2 + 36H^+ + 36e^-$ <i>Toluene Oxidation</i>	+2.96	+12.4	-0.128	+0.309	+5.22	pH = 7 $P_{CO_2} = 10^{-2}$
$16H_2O + C_6H_5C_2H_5 \Rightarrow 8CO_2 + 42H^+ + 42e^-$ <i>Ethylbenzene Oxidation</i>	+2.96	+12.4	-0.128	+0.309	+5.21	pH = 7 $P_{CO_2} = 10^{-2}$
$16H_2O + C_6H_4(CH_3)_2 \Rightarrow 8CO_2 + 42H^+ + 42e^-$ <i>m-Xylene Oxidation</i>	+3.03	+12.7	-0.132	+0.303	+5.12	pH = 7 $P_{CO_2} = 10^{-2}$
$20H_2O + C_{10}H_8 \Rightarrow 10CO_2 + 48H^+ + 48e^-$ <i>Naphthalene Oxidation</i>	+2.98	+12.5	-0.130 ^a	+0.309	+5.22	pH = 7 $P_{CO_2} = 10^{-2}$
$18H_2O + C_6H_3(CH_3)_3 \Rightarrow 9CO_2 + 48H^+ + 48e^-$ <i>1,3,5-Trimethylbenzene Oxidation</i>	+3.07	+12.8	-0.133 ^a	+0.303	+5.12	pH = 7 $P_{CO_2} = 10^{-2}$
$18H_2O + C_6H_3(CH_3)_3 \Rightarrow 9CO_2 + 48H^+ + 48e^-$ <i>1,2,4-Trimethylbenzene Oxidation</i>	+3.07	+12.9	-0.134 ^a	+0.302	+5.11	pH = 7 $P_{CO_2} = 10^{-2}$
$4H_2O + C_2H_2Cl_2 \Rightarrow 2CO_2 + 10H^+ + 8e^- + 2Cl^-$ <i>DCE Oxidation</i>	-3.88	-16.2	+0.168	-0.131	-2.21	pH = 7 $P_{CO_2} = 10^{-2}$
$4H_2O + C_2H_3Cl \Rightarrow 2CO_2 + 11H^+ + 10e^- + Cl^-$ <i>Vinyl Chloride Oxidation</i>	-0.55	-2.31	+0.024 ^a	-0.006	-0.10	pH = 7 $P_{CO_2} = 10^{-2}$
$12H_2O + C_6H_2Cl_4 \Rightarrow 6CO_2 + 26H^+ + 22e^- + 4Cl^-$ <i>Tetrachlorobenzene Oxidation</i>	-0.64	-2.68	+0.028	+0.016	+0.27	pH = 7 $P_{CO_2} = 10^{-2}$
$12H_2O + C_6H_3Cl_3 \Rightarrow 6CO_2 + 27H^+ + 24e^- + 3Cl^-$ <i>Trichlorobenzene Oxidation</i>	+0.42	+1.77	-0.018	-0.030	-0.50	pH = 7 $P_{CO_2} = 10^{-2}$
$12H_2O + C_6H_4Cl_2 \Rightarrow 6CO_2 + 28H^+ + 26e^- + 2Cl^-$ <i>Dichlorobenzene Oxidation</i>	+1.40	+5.84	-0.060	-0.071	-1.21	pH = 7 $P_{CO_2} = 10^{-2}$
$12H_2O + C_6H_5Cl \Rightarrow 6CO_2 + 29H^+ + 28e^- + Cl^-$ <i>Chlorobenzene Oxidation</i>	+2.22	+9.26	-0.096 ^a	-0.107	-1.80	pH = 7 $P_{CO_2} = 10^{-2}$

NOTES:

* = ΔG_r° for half-cell reaction as shown divided by the number of electrons involved in reaction.

§ = Conditions assumed for the calculation of Eh and pe (pe = Eh/0.05916). Where two dissolved species are involved, other than those mentioned in this column, their activities are taken as equal. Note, this does not affect the free energy values listed.

^a = E° calculated using the following equation; $E^\circ = \Delta G_r^\circ / (nF) * 1.0365 \times 10^{-5}$ (VF/J) from Stumm and Morgan, 1981.

Table B.3.6 *Gibbs Free Energy of Formation for Species used in Half-Cell Reactions and Coupled Oxidation-Reduction Reactions*

Species	State	$\Delta G_{f,298.15}^{\circ}$ (kcal/mole)	Source
e ⁻	i	0	std
H ⁺	i	0	std
O ₂	g	0	std
H ₂ O	l	-56.687	Dean (1972)
Carbon Species			
CO ₂	g	-94.26	Dean (1972)
CH ₂ O, formaldehyde	aq	-31.02	Dean (1972)
C ₆ H ₆ , benzene	l	+29.72	Dean (1972)
CH ₄ , methane	g	-12.15	Dean (1972)
C ₆ H ₅ CH ₃ , toluene	l	+27.19	Dean (1972)
C ₆ H ₅ C ₂ H ₅ , ethylbenzene	l	+28.61	Dean (1972)
C ₆ H ₄ (CH ₃) ₂ , o-xylene	l	+26.37	Dean (1972)
C ₆ H ₄ (CH ₃) ₂ , m-xylene	l	+25.73	Dean (1972)
C ₆ H ₄ (CH ₃) ₂ , p-xylene	l	+26.31	Dean (1972)
C ₂ Cl ₄ , PCE	l	+1.1	CRC Handbook (1996)
C ₂ HCl ₃ , TCE	l	+2.9	CRC Handbook (1996)
C ₂ H ₂ Cl ₂ 1,1-dichloroethene	l	+5.85	Dean (1972)
C ₂ H ₂ Cl ₂ cis-1,2-dichloroethene	l	5.27	CRC Handbook (1996)
C ₂ H ₂ Cl ₂ trans-1,2-dichloroethene	l	+6.52	CRC Handbook (1996)
C ₂ H ₄ Ethene	g aq, m=1	+16.28 +19.43	CRC Handbook (1996)
C ₂ H ₆ Ethane	g aq, m=1	-7.68 -4.09	CRC Handbook (1996)
HCl hydrochloric acid	aq, m=1	-31.372	CRC Handbook (1996)a
C ₂ H ₂ Cl ₄ , 1,1,2,2-PCA	l	-22.73	Dean (1972)
C ₂ H ₃ Cl ₃ , 1,1,2-TCA	g	-18.54	Dean (1972)
C ₂ H ₄ Cl ₂ , 1,2-DCA	g	-17.68	Dean (1972)
C ₂ H ₅ Cl ₁ , Chloroethane	g	-14.47	Dean (1972)
C ₁₀ H ₈ , naphthalene	l	+48.05	Dean (1972)
C ₆ H ₃ (CH ₃) ₃ , 1,3,5-TMB	l	+24.83	Dean (1972)
C ₆ H ₃ (CH ₃) ₃ , 1,2,4-TMB	l	+24.46	Dean (1972)
C ₂ H ₃ Cl, Vinyl chloride	g	+12.4	Dean (1972)
C ₆ Cl ₆ , Hexachlorobenzene	l	+0.502	Dolfing and Harrison (1992)
C ₆ H ₁ Cl ₅ , Pentachlorobenzene	l	+3.16	Dolfing and Harrison (1992)
C ₆ H ₂ Cl ₄ , 1,2,4,5-Tetrachlorobenzene	l	+5.26	Dolfing and Harrison (1992)
C ₆ H ₃ Cl ₃ , 1,2,4-Trichlorobenzene	l	+9.31	Dolfing and Harrison (1992)
C ₆ H ₄ Cl ₂ , 1,4-Dichlorobenzene	l	+14.28	Dolfing and Harrison (1992)
C ₆ H ₅ Cl, chlorobenzene	l	+21.32	Dean (1972)
C ₁₄ H ₁₀ , phenanthrene	l	+64.12	Dean (1972)

Table B.3.6 Continued.

Species	State	$\Delta G_{f,298.15}^{\circ}$ (kcal/mole)	Source
Nitrogen Species			
NO ₃ ⁻	l	-26.61	Dean (1972)
N ₂	g	0	std
NO ₂ ⁻	l	-7.7	Dean (1972)
NH ₄ ⁺	aq	-18.97	Dean (1972)
Sulfur Species			
SO ₄ ²⁻	i	-177.97	Dean (1972)
H ₂ S	aq	-6.66	Dean (1972)
H ₂ S	g	-7.9	Dean (1972)
HS ⁻	i	+2.88	Dean (1972)
Iron Species			
Fe ²⁺	i	-18.85	Dean (1972)
Fe ³⁺	i	-1.1	Dean (1972)
Fe ₂ O ₃ , hematite	c	-177.4	Dean (1972)
FeOOH, ferric oxyhydroxide	c	-117.2	Naumov <i>et al.</i> (1974)
Fe(OH) ₃ , goethite	a	-167.416	Langmuir and Whittemore (1971)
Fe(OH) ₃ , goethite	c	-177.148	Langmuir and Whittemore (1971)
FeCO ₃ , siderite	c	-159.35	Dean (1972)
Manganese Species			
Mn ²⁺	i	-54.5	Dean (1972)
MnO ₂ , pyrolusite	c	-111.18	Stumm and Morgan (1981)
MnOOH, manganite	c	-133.29	Stumm and Morgan (1981)
MnCO ₃ , rhodochrosite	p	-194	Dean (1972)
Chloride Species			
Cl ⁻	aq	-31.37	Dean (1972)

NOTES:

c = crystallized solid l = liquid g = gaseous aq = undissociated aqueous species

a = amorphous solid (may be partially crystallized - dependent on methods of preparation)

p = freshly precipitated solid

i = dissociated, aqueous ionic species (concentration = 1 m)

std = accepted by convention

Wherever possible multiple sources were consulted to eliminate the possibility of typographical error.

Table B.3.7 Coupled Oxidation-Reduction Reactions

Coupled Benzene Oxidation Reactions	ΔG°_r (kcal/mole)	ΔG°_r (kJ/ mole)	Stoichiometric Mass Ratio of Electron Acceptor or Metabolic Byproduct to Primary Substrate	Mass of Primary Substrate Utilized per Mass of Electron Acceptor Utilized or Metabolic Byproduct Produced
$7.5O_2 + C_6H_6 \Rightarrow 6CO_{2,g} + 3H_2O$ <i>Benzene oxidation /aerobic respiration</i>	-765.34	-3202	3.07:1	0.326:1
$6NO_3 + 6H^+ + C_6H_6 \Rightarrow 6CO_{2,g} + 6H_2O + 3N_{2,g}$ <i>Benzene oxidation / denitrification</i>	-775.75	-3245	4.77:1	0.210:1
$30H^+ + 15MnO_2 + C_6H_6 \Rightarrow 6CO_{2,g} + 15Mn^{2+} + 18H_2O$ <i>Benzene oxidation / manganese reduction</i>	-765.45	-3202	10.56:1	0.095:1
$3.75 NO_3^- + C_6H_6 + 7.5 H^+ + 0.75 H_2O \Rightarrow 6 CO_2 + 3.75 NH_4^+$ <i>Benzene oxidation / nitrate reduction</i>	-524.1	-2193	2.98:1	0.336:1
$60H^+ + 30Fe(OH)_{3,a} + C_6H_6 \Rightarrow 6CO_2 + 30Fe^{2+} + 78H_2O$ <i>Benzene oxidation / iron reduction</i>	-560.10	-2343	21.5:1	0.047:1
$7.5H^+ + 3.75SO_4^{2-} + C_6H_6 \Rightarrow 6CO_{2,g} + 3.75H_2S^0 + 3H_2O$ <i>Benzene oxidation / sulfate reduction</i>	-122.93	-514.3	4.61:1	0.22:1
$4.5H_2O + C_6H_6 \Rightarrow 2.25CO_{2,g} + 3.75CH_4$ <i>Benzene oxidation / methanogenesis</i>	-32.40	-135.6	0.77:1	1.30:1
$15 C_2H_2Cl_4 + C_6H_6 + 12 H_2O \Rightarrow 6 CO_2 + 15 C_2H_3Cl_3 + 15 H^+ + 15 Cl^-$ <i>Benzene oxidation / PCA reduction</i>	-322.7	-1349	32.2:1	0.03:1
$15 C_2H_3Cl_3 + C_6H_6 + 12 H_2O \Rightarrow 6 CO_2 + 15 C_2H_4Cl_2 + 15 H^+ + 15 Cl^-$ <i>Benzene oxidation / TCA reduction</i>	-372.65	-1558	25.6:1	0.04:1
$15 C_2H_4Cl_2 + C_6H_6 + 12 H_2O \Rightarrow 6 CO_2 + 15 C_2H_5Cl + 15 H^+ + 15 Cl^-$ <i>Benzene oxidation / DCA reduction</i>	-337.40	-1410	19.0:1	0.05:1
$15C_2Cl_4 + 12H_2O + C_6H_6 \Rightarrow 15C_2HCl_3 + 6CO_2 + 15H^+ + 15Cl^-$ <i>Benzene oxidation/ Tetrachloroethylene reductive dehalogenation</i>	-358.55	-1499	31.8:1	0.03:1
$15C_2HCl_3 + 12H_2O + C_6H_6 \Rightarrow 15C_2H_2Cl_2 + 6CO_2 + 15H^+ + 15Cl^-$ <i>Benzene oxidation/ Trichloroethylene reductive dehalogenation</i>	-331.25	-1385	25.2:1	0.04:1
$15C_2H_2Cl_2 + 12H_2O + C_6H_6 \Rightarrow 15C_2H_3Cl + 6CO_2 + 15H^+ + 15Cl^-$ <i>Benzene oxidation/ cis-Dichloroethylene reductive dehalogenation</i>	-297.35	-1243	18.6:1	0.05:1
$15C_2H_3Cl + 12H_2O + C_6H_6 \Rightarrow 15C_2H_4 + 6CO_2 + 15H^+ + 15Cl^-$ <i>Benzene oxidation/ Vinyl chloride reductive dehalogenation</i>	-327.35	-1368	12.0:1	0.08:1
$15C_6Cl_6 + 12H_2O + C_6H_6 \Rightarrow 15C_6H_1Cl_5 + 6CO_2 + 15H^+ + 15Cl^-$ <i>Benzene oxidation/ Hexachlorobenzene reductive dehalogenation</i>	-345.68	-1445	54.7:1	0.02:1
$15C_6H_1Cl_5 + 12H_2O + C_6H_6 \Rightarrow 15C_6H_2Cl_4 + 6CO_2 + 15H^+ + 15Cl^-$ <i>Benzene oxidation/ Pentachlorobenzene reductive dehalogenation</i>	-354.05	-1480	48.1:1	0.02:1
$15C_6H_2Cl_4 + 12H_2O + C_6H_6 \Rightarrow 15C_6H_3Cl_3 + 6CO_2 + 15H^+ + 15Cl^-$ <i>Benzene oxidation/ Tetrachlorobenzene reductive dehalogenation</i>	-324.80	-1358	41.5:1	0.02:1
$15C_6H_3Cl_3 + 12H_2O + C_6H_6 \Rightarrow 15C_6H_4Cl_2 + 6CO_2 + 15H^+ + 15Cl^-$ <i>Benzene oxidation/ Trichlorobenzene reductive dehalogenation</i>	-311.0	-1300	34.8:1	0.03:1

Table B.3.7 Continued.

Coupled Toluene Oxidation Reactions	ΔG°_r (kcal/ mole)	ΔG°_r (kJ/ mole)	Stoichiometric Mass Ratio of Electron Acceptor or Metabolic Byproduct to Primary Substrate	Mass of Primary Substrate Utilized per Mass of Electron Acceptor Utilized or Metabolic Byproduct Produced
$9O_2 + C_6H_5CH_3 \Rightarrow 7CO_{2,g} + 4H_2O$ <i>Toluene oxidation/aerobic respiration</i>	-913.76	-3823	3.13:1	0.32:1
$7.2NO_3 + 7.2H^+ + C_6H_5CH_3 \Rightarrow 7CO_{2,g} + 7.6H_2O + 3.6N_{2,g}$ <i>Toluene oxidation/denitrification</i>	-926.31	-3875	4.85:1	0.21:1
$36H^+ + 18MnO_2 + C_6H_5CH_3 \Rightarrow 7CO_{2,g} + 18Mn^{2+} + 22H_2O$ <i>Toluene oxidation/manganese reduction</i>	-913.89	-3824	10.74:1	0.09:1
$72H^+ + 36Fe(OH)_{3,a} + C_6H_5CH_3 \Rightarrow 7CO_2 + 36Fe^{2+} + 94H_2O$ <i>Toluene oxidation/iron reduction</i>	-667.21	-2792	21.86:1	0.05:1
$9H^+ + 4.5SO_4^{2-} + C_6H_5CH_3 \Rightarrow 7CO_{2,g} + 4.5H_2S^0 + 4H_2O$ <i>Toluene oxidation/sulfate reduction</i>	-142.86	-597.7	4.7:1	0.21:1
$5H_2O + C_6H_5CH_3 \Rightarrow 2.5CO_{2,g} + 4.5CH_4$ <i>Toluene oxidation/methanogenesis</i>	-34.08	-142.6	0.78:1	1.28:1
$18C_2H_2Cl_4 + C_6H_5CH_3 + 14H_2O \Rightarrow 7CO_2 + 18C_2H_3Cl_3 + 18H^+ + 18Cl^-$ <i>Toluene oxidation/PCA reduction</i>	-382.6	-1599	32.8:1	0.03:1
$18C_2H_3Cl_3 + C_6H_5CH_3 + 14H_2O \Rightarrow 7CO_2 + 18C_2H_4Cl_2 + 18H^+ + 18Cl^-$ <i>Toluene oxidation/TCA reduction</i>	-442.5	-1850	26.1:1	0.04:1
$18C_2H_4Cl_2 + C_6H_5CH_3 + 14H_2O \Rightarrow 7CO_2 + 18C_2H_5Cl + 18H^+ + 18Cl^-$ <i>Toluene oxidation/DCA reduction</i>	-400.2	-1673	19.3:1	0.05:1
$18C_2Cl_4 + 14H_2O + C_6H_5CH_3 \Rightarrow 18C_2HCl_3 + 7CO_2 + 18H^+ + 18Cl^-$ <i>Toluene oxidation/Tetrachloroethylene reductive dehalogenation</i>	-425.6	-1779	32.4:1	0.03:1
$18C_2HCl_3 + 14H_2O + C_6H_5CH_3 \Rightarrow 18C_2H_2Cl_2 + 7CO_2 + 18H^+ + 18Cl^-$ <i>Toluene oxidation/Trichloroethylene reductive dehalogenation</i>	-404.9	-1693	25.7:1	0.04:1
$18C_2H_2Cl_2 + 14H_2O + C_6H_5CH_3 \Rightarrow 18C_2H_3Cl + 7CO_2 + 18H^+ + 18Cl^-$ <i>Toluene oxidation/cis-Dichloroethylene reductive dehalogenation</i>	-340.1	-1422	18.9:1	0.05:1
$18C_2H_3Cl + 14H_2O + C_6H_5CH_3 \Rightarrow 18C_2H_4 + 7CO_2 + 18H^+ + 18Cl^-$ <i>Toluene oxidation/Vinyl chloride reductive dehalogenation</i>	-331.5	-1386	12.2:1	0.08:1
$18C_6Cl_6 + 14H_2O + C_6H_5CH_3 \Rightarrow 18C_6H_1Cl_5 + 7CO_2 + 18H^+ + 18Cl^-$ <i>Toluene oxidation/Hexachlorobenzene reductive dehalogenation</i>	-410.3	-1715	55.6:1	0.02:1
$18C_6H_1Cl_5 + 14H_2O + C_6H_5CH_3 \Rightarrow 18C_6H_2Cl_4 + 7CO_2 + 18H^+ + 18Cl^-$ <i>Toluene oxidation/Pentachlorobenzene reductive dehalogenation</i>	-420.3	-1757	48.9:1	0.02:1
$18C_6H_2Cl_4 + 14H_2O + C_6H_5CH_3 \Rightarrow 18C_6H_3Cl_3 + 7CO_2 + 18H^+ + 18Cl^-$ <i>Toluene oxidation/Tetrachlorobenzene reductive dehalogenation</i>	-385.2	-1610	42.2:1	0.02:1
$18C_6H_3Cl_3 + 14H_2O + C_6H_5CH_3 \Rightarrow 18C_6H_4Cl_2 + 7CO_2 + 18H^+ + 18Cl^-$ <i>Toluene oxidation/Trichlorobenzene reductive dehalogenation</i>	-368.6	-1541	35.4:1	0.03:1

Table B.3.7 Continued.

Coupled Ethylbenzene Oxidation reactions	ΔG°_r kcal/ mole	ΔG°_r kJ/ mole	Stoichiometric Mass Ratio of Electron Acceptor or Metabolic Byproduct to Primary Substrate	Mass of Primary Substrate Utilized per Mass of Electron Acceptor Utilized or Metabolic Byproduct Produced
$10.5O_2 + C_6H_5C_2H_5 \Rightarrow 8CO_{2,g} + 5H_2O$ <i>Ethylbenzene oxidation /aerobic respiration</i>	-1066.13	-4461	3.17:1	0.32:1
$8.4NO_3 + 8.4H^+ + C_6H_5C_2H_5 \Rightarrow 8CO_{2,g} + 9.2H_2O + 4.2N_{2,g}$ <i>Ethylbenzene oxidation / denitrification</i>	-1080.76	-4522	4.92:1	0.20:1
$46H^+ + 22MnO_2 + C_6H_5C_2H_5 \Rightarrow 8CO_{2,g} + 22Mn^{2+} + 28H_2O$ <i>Ethylbenzene oxidation / manganese reduction</i>	-1066.27	-4461	11.39:1	0.09:1
$84H^+ + 42Fe(OH)_{3,a} + C_6H_5C_2H_5 \Rightarrow 8CO_2 + 42Fe^{2+} + 110H_2O$ <i>Ethylbenzene oxidation / iron reduction</i>	-778.48	-3257	22.0:1	0.05:1
$10.5H^+ + 5.25SO_4^{2-} + C_6H_5C_2H_5 \Rightarrow 8CO_{2,g} + 5.25H_2S^0 + 5H_2$ <i>Ethylbenzene oxidation / sulfate reduction</i>	-166.75	-697.7	4.75:1	0.21:1
$5.5H_2O + C_6H_5C_2H_5 \Rightarrow 2.75CO_{2,g} + 5.25CH_4$ <i>Ethylbenzene oxidation / methanogenesis</i>	-39.83	-166.7	0.79:1	1.27:1
$21C_2H_2Cl_4 + 16H_2O + C_6H_5C_2H_5 \Rightarrow 21C_2H_3Cl_3 + 8CO_2 + 21H^+ + 21Cl^-$ <i>Ethylbenzene oxidation/ PCA reductive dehalogenation</i>	-446.43	-1866	32.8:1	0.03:1
$21C_2H_3Cl_3 + 16H_2O + C_6H_5C_2H_5 \Rightarrow 21C_2H_4Cl_2 + 8CO_2 + 21H^+ + 21Cl^-$ <i>Ethylbenzene oxidation/ TCA reductive dehalogenation</i>	-516.36	-2158	26.1:1	0.04:1
$21C_2H_4Cl_2 + 16H_2O + C_6H_5C_2H_5 \Rightarrow 21C_2H_5Cl + 8CO_2 + 21H^+ + 21Cl^-$ <i>Ethylbenzene oxidation/ DCA reductive dehalogenation</i>	-467.01	-1952	19.4:1	0.05:1
$21C_2Cl_4 + 16H_2O + C_6H_5C_2H_5 \Rightarrow 21C_2HCl_3 + 8CO_2 + 21H^+ + 21Cl^-$ <i>Ethylbenzene oxidation/ Tetrachloroethylene reductive dehalogenation</i>	-496.67	-2078	32.8:1	0.03:1
$21C_2HCl_3 + 16H_2O + C_6H_5C_2H_5 \Rightarrow 21C_2H_2Cl_2 + 8CO_2 + 21H^+ + 21Cl^-$ <i>Ethylbenzene oxidation/ Trichloroethylene reductive dehalogenation</i>	-484.70	-2028	26.0:1	0.04:1
$21C_2H_2Cl_2 + 16H_2O + C_6H_5C_2H_5 \Rightarrow 21C_2H_3Cl + 8CO_2 + 21H^+ + 21Cl^-$ <i>Ethylbenzene oxidation/ cis-Dichloroethylene reductive dehalogenation</i>	-384.74	-1610	19.2:1	0.05:1
$21C_2H_3Cl + 16H_2O + C_6H_5C_2H_5 \Rightarrow 21C_2H_4 + 8CO_2 + 21H^+ + 21Cl^-$ <i>Ethylbenzene oxidation/ Vinyl chloride reductive dehalogenation</i>	-368.79	-1617	12.3:1	0.08:1
$21C_6Cl_6 + 16H_2O + C_6H_5C_2H_5 \Rightarrow 21C_6H_1Cl_5 + 8CO_2 + 21H^+ + 21Cl^-$ <i>Ethylbenzene oxidation/ Hexachlorobenzene reductive dehalogenation</i>	-478.7	-2001	55.6:1	0.02:1
$21C_6H_1Cl_5 + 16H_2O + C_6H_5C_2H_5 \Rightarrow 21C_6H_2Cl_4 + 8CO_2 + 21H^+ + 21Cl^-$ <i>Ethylbenzene oxidation/ Pentachlorobenzene reductive dehalogenation</i>	-490.4	-2050	48.9:1	0.02:1
$21C_6H_2Cl_4 + 16H_2O + C_6H_5C_2H_5 \Rightarrow 21C_6H_3Cl_3 + 8CO_2 + 21H^+ + 21Cl^-$ <i>Ethylbenzene oxidation/ Tetrachlorobenzene reductive dehalogenation</i>	-449.4	-1878	42.2:1	0.02:1
$21C_6H_3Cl_3 + 16H_2O + C_6H_5C_2H_5 \Rightarrow 21C_6H_4Cl_2 + 8CO_2 + 21H^+ + 21Cl^-$ <i>Ethylbenzene oxidation/ Trichlorobenzene reductive dehalogenation</i>	-430.1	-1794	35.5:1	0.03:1

Table B.3.7 Continued.

Coupled m-Xylene Oxidation Reactions	ΔG°_r (kcal/ mole)	ΔG°_r (kJ/ mole)	Stoichiometric Mass Ratio of Electron Acceptor or Metabolic Byproduct to Primary Substrate	Mass of Primary Substrate Utilized per Mass of Electron Acceptor Utilized or Metabolic Byproduct Produced
$10.5 \text{ O}_2 + \text{C}_6\text{H}_4(\text{CH}_3)_2 \Rightarrow 8\text{CO}_2 + 5 \text{H}_2\text{O}$ <i>m-Xylene oxidation / aerobic respiration</i>	-1063.25	-4448	3.17:1	0.32:1
$8.4 \text{ H}^+ + 8.4\text{NO}_3^- + \text{C}_6\text{H}_4(\text{CH}_3)_2 \Rightarrow 8\text{CO}_2 + 4.2 \text{N}_2 + 9.2 \text{H}_2\text{O}$ <i>m-Xylene oxidation / denitrification</i>	-1077.81	-4509	4.92:1	0.20:1
$46 \text{ H}^+ + 22\text{MnO}_2 + \text{C}_6\text{H}_4(\text{CH}_3)_2 \Rightarrow 8\text{CO}_2 + 22 \text{Mn}^{2+} + 28 \text{H}_2\text{O}$ <i>m-Xylene oxidation / manganese reduction</i>	-1063.39	-4449	11.39:1	0.09:1
$84 \text{ H}^+ + 42\text{Fe}(\text{OH})_3 + \text{C}_6\text{H}_4(\text{CH}_3)_2 \Rightarrow 8\text{CO}_2 + 42 \text{Fe}^{2+} + 110 \text{H}_2\text{O}$ <i>m-Xylene oxidation / iron reduction</i>	-775.61	-3245	22:1	0.05:1
$10.5\text{H}^+ + 5.25\text{SO}_4^{2-} + \text{C}_6\text{H}_4(\text{CH}_3)_2 \Rightarrow 8\text{CO}_2 + 5.25 \text{H}_2\text{S}^0 + 5 \text{H}_2\text{O}$ <i>m-Xylene oxidation / sulfate reduction</i>	-163.87	-685.6	4.75:1	0.21:1
$5.5\text{H}_2\text{O} + \text{C}_6\text{H}_4(\text{CH}_3)_2 \Rightarrow 2.75\text{CO}_2 + 5.25\text{CH}_4$ <i>m-Xylene oxidation / methanogenesis</i>	-36.95	-154.6	0.79:1 ^{av}	1.27:1
$21\text{C}_2\text{H}_2\text{Cl}_4 + 16\text{H}_2\text{O} + \text{C}_6\text{H}_4(\text{CH}_3)_2 \Rightarrow 21\text{C}_2\text{H}_3\text{Cl}_3 + 8\text{CO}_2 + 21\text{H}^+ + 21\text{Cl}^-$ <i>m-Xylene oxidation/ PCA reductive dehalogenation</i>	-445.70	-1863	32.7:1	0.03:1
$21\text{C}_2\text{H}_3\text{Cl}_3 + 16\text{H}_2\text{O} + \text{C}_6\text{H}_4(\text{CH}_3)_2 \Rightarrow 21\text{C}_2\text{H}_4\text{Cl}_2 + 8\text{CO}_2 + 21\text{H}^+ + 21\text{Cl}^-$ <i>m-Xylene oxidation/ TCA reductive dehalogenation</i>	-513.48	-2146	26.0:1	0.04:1
$21\text{C}_2\text{H}_4\text{Cl}_2 + 16\text{H}_2\text{O} + \text{C}_6\text{H}_4(\text{CH}_3)_2 \Rightarrow 21\text{C}_2\text{H}_5\text{Cl} + 8\text{CO}_2 + 21\text{H}^+ + 21\text{Cl}^-$ <i>m-Xylene oxidation/ DCA reductive dehalogenation</i>	-464.13	-1940	19.3:	0.05:1
$21\text{C}_2\text{Cl}_4 + 16\text{H}_2\text{O} + \text{C}_6\text{H}_4(\text{CH}_3)_2 \Rightarrow 21\text{C}_2\text{HCl}_3 + 8\text{CO}_2 + 21\text{H}^+ + 21\text{Cl}^-$ <i>m-Xylene oxidation/ Tetrachloroethylene reductive dehalogenation</i>	-493.79	-2066	32.8:1	0.03:1
$21\text{C}_2\text{HCl}_3 + 16\text{H}_2\text{O} + \text{C}_6\text{H}_4(\text{CH}_3)_2 \Rightarrow 21\text{C}_2\text{H}_2\text{Cl}_2 + 8\text{CO}_2 + 21\text{H}^+ + 21\text{Cl}^-$ <i>m-Xylene oxidation/ Trichloroethylene reductive dehalogenation</i>	-469.59	-1963	26.0:1	0.04:1
$21\text{C}_2\text{H}_2\text{Cl}_2 + 16\text{H}_2\text{O} + \text{C}_6\text{H}_4(\text{CH}_3)_2 \Rightarrow 21\text{C}_2\text{H}_3\text{Cl} + 8\text{CO}_2 + 21\text{H}^+ + 21\text{Cl}^-$ <i>m-Xylene oxidation/ cis-Dichloroethylene reductive dehalogenation</i>	-393.99	-1647	19.2:1	0.05:1
$21\text{C}_2\text{H}_3\text{Cl} + 16\text{H}_2\text{O} + \text{C}_6\text{H}_4(\text{CH}_3)_2 \Rightarrow 21\text{C}_2\text{H}_4 + 8\text{CO}_2 + 21\text{H}^+ + 21\text{Cl}^-$ <i>m-Xylene oxidation/ Vinyl chloride reductive dehalogenation</i>	-383.91	-1605	12.3:1	0.08:1
$21\text{C}_6\text{Cl}_6 + 16\text{H}_2\text{O} + \text{C}_6\text{H}_4(\text{CH}_3)_2 \Rightarrow 21\text{C}_6\text{H}_1\text{Cl}_5 + 8\text{CO}_2 + 21\text{H}^+ + 21\text{Cl}^-$ <i>m-Xylene oxidation/ Hexachlorobenzene reductive dehalogenation</i>	-475.9	-1989	55.6:1	0.02:1
$21\text{C}_6\text{H}_1\text{Cl}_5 + 16\text{H}_2\text{O} + \text{C}_6\text{H}_4(\text{CH}_3)_2 \Rightarrow 21\text{C}_6\text{H}_2\text{Cl}_4 + 8\text{CO}_2 + 21\text{H}^+ + 21\text{Cl}^-$ <i>m-Xylene oxidation/ Pentachlorobenzene reductive dehalogenation</i>	-487.5	-2038	48.9:1	0.02:1
$21\text{C}_6\text{H}_2\text{Cl}_4 + 16\text{H}_2\text{O} + \text{C}_6\text{H}_4(\text{CH}_3)_2 \Rightarrow 21\text{C}_6\text{H}_3\text{Cl}_3 + 8\text{CO}_2 + 21\text{H}^+ + 21\text{Cl}^-$ <i>m-Xylene oxidation/ Tetrachlorobenzene reductive dehalogenation</i>	-446.6	-1867	42.2:1	0.02:1
$21\text{C}_6\text{H}_3\text{Cl}_3 + 16\text{H}_2\text{O} + \text{C}_6\text{H}_4(\text{CH}_3)_2 \Rightarrow 21\text{C}_6\text{H}_4\text{Cl}_2 + 8\text{CO}_2 + 21\text{H}^+ + 21\text{Cl}^-$ <i>m-Xylene oxidation/ Trichlorobenzene reductive dehalogenation</i>	-426.9	-1784	35.5:1	0.03:1

Table B.3.7 Continued.

Coupled Naphthalene Oxidation Reactions	ΔG°_r (kcal/ mole)	ΔG°_r (kJ/ mole)	Stoichiometric Mass Ratio of Electron Acceptor or Metabolic Byproduct to Primary Substrate	Mass of Primary Substrate Utilized per Mass of Electron Acceptor Utilized or Metabolic Byproduct Produced
$12O_2 + C_{10}H_8 \Rightarrow 10CO_2 + 4H_2O$ <i>Naphthalene oxidation/aerobic respiration</i>	-1217.40	-5094	3.00:1	0.33:1
$9.6NO_3^- + 9.6H^+ + C_{10}H_8 \Rightarrow 10CO_2 + 8.8H_2O + 4.8N_2$ <i>Naphthalene oxidation/denitrification</i>	-1234.04	-5163	4.65:1	0.22:1
$24MnO_2 + 48H^+ + C_{10}H_8 \Rightarrow 10CO_2 + 24Mn^{2+} + 28H_2O$ <i>Naphthalene oxidation/manganese reduction</i>	-1217.57	-5094	16.31:1	0.06:1
$48Fe(OH)_3 + 96H^+ + C_{10}H_8 \Rightarrow 10CO_2 + 48Fe^{2+} + 124H_2O$ <i>Naphthalene oxidation/iron reduction</i>	-932.64	-3902	40.13:1	0.02:1
$6SO_4^{2-} + 12H^+ + C_{10}H_8 \Rightarrow 10CO_2 + 6H_2S^0 + 4H_2O$ Error! Switch argument not specified. <i>Naphthalene oxidation/ sulfate reduction</i>	-196.98	-824.2	4.50:1	0.22:1
$8H_2O + C_{10}H_8 \Rightarrow 4CO_2 + 6CH_4$ <i>Naphthalene oxidation/methanogenesis</i>	-44.49	-186.1	1.13:1	0.88:1
$24C_2H_2Cl_4 + 20H_2O + C_{10}H_8 \Rightarrow 24C_2H_3Cl_3 + 10CO_2 + 24H^+ + 24Cl^-$ <i>Naphthalene oxidation/PCA reductive dehalogenation</i>	-511.68	-2139	31.1:1	0.03:1
$24C_2H_3Cl_3 + 20H_2O + C_{10}H_8 \Rightarrow 24C_2H_4Cl_2 + 10CO_2 + 24H^+ + 24Cl^-$ <i>Naphthalene oxidation/TCA reductive dehalogenation</i>	-589.09	-2462	24.8:1	0.04:1
$24C_2H_4Cl_2 + 20H_2O + C_{10}H_8 \Rightarrow 24C_2H_3Cl + 10CO_2 + 24H^+ + 24Cl^-$ <i>Naphthalene oxidation/DCA reductive dehalogenation</i>	-532.69	-2227	18.4:1	0.05:1
$24C_2Cl_4 + 20H_2O + C_{10}H_8 \Rightarrow 24C_2HCl_3 + 10CO_2 + 24H^+ + 24Cl^-$ <i>Naphthalene oxidation/Tetrachloroethylene reductive dehalogenation</i>	-566.59	-2371	31.1:1	0.03:1
$24C_2HCl_3 + 20H_2O + C_{10}H_8 \Rightarrow 24C_2H_2Cl_2 + 10CO_2 + 24H^+ + 24Cl^-$ <i>Naphthalene oxidation/Trichloroethylene reductive dehalogenation</i>	-552.91	-2313	24.6:1	0.04:1
$24C_2H_2Cl_2 + 20H_2O + C_{10}H_8 \Rightarrow 24C_2H_3Cl + 10CO_2 + 24H^+ + 24Cl^-$ <i>Naphthalene oxidation/cis-Dichloroethylene reductive dehalogenation</i>	-438.67	-1835	18.2:1	0.05:1
$24C_2H_3Cl + 20H_2O + C_{10}H_8 \Rightarrow 24C_2H_4 + 10CO_2 + 24H^+ + 24Cl^-$ <i>Naphthalene oxidation/Vinyl chloride reductive dehalogenation</i>	-441.01	-1843	11.6:1	0.09:1
$24C_6Cl_6 + 20H_2O + C_{10}H_8 \Rightarrow 24C_6H_1Cl_5 + 10CO_2 + 24H^+ + 24Cl^-$ <i>Naphthalene oxidation/Hexachlorobenzene reductive dehalogenation</i>	-545.94	-2282	52.9:1	0.02:1
$24C_6H_1Cl_5 + 20H_2O + C_{10}H_8 \Rightarrow 24C_6H_2Cl_4 + 10CO_2 + 24H^+ + 24Cl^-$ <i>Naphthalene oxidation/Pentachlorobenzene reductive dehalogenation</i>	-559.33	-2338	46.5:1	0.02:1
$24C_6H_2Cl_4 + 20H_2O + C_{10}H_8 \Rightarrow 24C_6H_3Cl_3 + 10CO_2 + 24H^+ + 24Cl^-$ <i>Naphthalene oxidation/Tetrachlorobenzene reductive dehalogenation</i>	-512.53	-2142	40.1:1	0.02:1
$24C_6H_3Cl_3 + 20H_2O + C_{10}H_8 \Rightarrow 24C_6H_4Cl_2 + 10CO_2 + 24H^+ + 24Cl^-$ <i>Naphthalene oxidation/Trichlorobenzene reductive dehalogenation</i>	-490.45	-2050	33.8:1	0.03:1

Table B.3.7 Continued.

Coupled 1,3,5-Trimethylbenzene (1,3,5-TMB) Oxidation Reactions	ΔG°_r (kcal/ mole)	ΔG°_r (kJ/ mole)	Stoichiometric Mass Ratio of Electron Acceptor or Metabolic Byproduct to Primary Substrate	Mass of Primary Substrate Utilized per Mass of Electron Acceptor Utilized or Metabolic Byproduct Produced
$12O_2 + C_6H_3(CH_3)_3 \Rightarrow 9CO_2 + 6H_2O$ <i>1,3,5-TMB oxidation / aerobic respiration</i>	-1213.29	-5076	3.20:1	0.31:1
$9.6NO_3^- + 9.6H^+ + C_6H_3(CH_3)_3 \Rightarrow 9CO_2 + 10.8H_2O + 4.8N_{2,g}$ <i>1,3,5-TMB oxidation / denitrification</i>	-1229.93	-5146	4.96:1	0.20:1
$24MnO_2 + 48H^+ + C_6H_3(CH_3)_3 \Rightarrow 9CO_2 + 30H_2O + 24Mn^{2+}$ <i>1,3,5-TMB oxidation / manganese reduction</i>	-1213.46	-5077	17.40:1	0.06:1
$48Fe(OH)_{3,a} + 96H^+ + C_6H_3(CH_3)_3 \Rightarrow 9CO_2 + 48Fe^{2+} + 126H_2O$ <i>1,3,5-TMB oxidation / iron reduction</i>	-928.53	-3885	42.80:1	0.02:1
$6SO_4^{2-} + 12H^+ + C_6H_3(CH_3)_3 \Rightarrow 9CO_2 + 6H_2O + 6H_2S^o$ <i>1,3,5-TMB oxidation / sulfate reduction</i>	-192.87	-807.0	4.80:1	0.21:1
$6H_2O + C_6H_3(CH_3)_3 \Rightarrow 3CO_2 + 6CH_4$ <i>1,3,5-TMB oxidation / methanogenesis</i>	-40.39	-169.0	0.90:1	1.11:1
$24 C_2H_2Cl_4 + 18H_2O + C_6H_3(CH_3)_3 \Rightarrow 24C_2H_3Cl_3 + 9CO_2 + 24H^+ + 24Cl^-$ <i>1,3,5-TMB oxidation/ PCA reductive dehalogenation</i>	-507.36	-2121	33.2:1	0.03:1
$24C_2H_3Cl_3 + 18H_2O + C_6H_3(CH_3)_3 \Rightarrow 24C_2H_4Cl_2 + 9CO_2 + 24H^+ + 24Cl^-$ <i>1,3,5-TMB oxidation/ TCA reductive dehalogenation</i>	-584.99	-2445	26.4:1	0.04:1
$24C_2H_4Cl_2 + 18H_2O + C_6H_3(CH_3)_3 \Rightarrow 24C_2H_5Cl + 9CO_2 + 24H^+ + 24Cl^-$ <i>1,3,5-TMB oxidation/ DCA reductive dehalogenation</i>	-528.59	-2210	19.6:1	0.05:1
$24C_2Cl_4 + 18H_2O + C_6H_3(CH_3)_3 \Rightarrow 24C_2HCl_3 + 9CO_2 + 24H^+ + 24Cl^-$ <i>1,3,5-TMB oxidation/ Tetrachloroethene reductive dehalogenation</i>	-562.48	-2353	33.2:1	0.03:1
$24C_2HCl_3 + 18H_2O + C_6H_3(CH_3)_3 \Rightarrow 24C_2H_2Cl_2 + 9CO_2 + 24H^+ + 24Cl^-$ <i>1,3,5-TMB oxidation/ Trichloroethene reductive dehalogenation</i>	-548.80	-2296	26.3:1	0.04:1
$24C_2H_2Cl_2 + 18H_2O + C_6H_3(CH_3)_3 \Rightarrow 24C_2H_3Cl + 9CO_2 + 24H^+ + 24Cl^-$ <i>1,3,5-TMB oxidation/ cis-Dichloroethene reductive dehalogenation</i>	-434.56	-1818	19.4:1	0.05:1
$24C_2H_3Cl + 18H_2O + C_6H_3(CH_3)_3 \Rightarrow 24C_2H_4 + 9CO_2 + 24H^+ + 24Cl^-$ <i>1,3,5-TMB oxidation/ Vinyl chloride reductive dehalogenation</i>	-436.91	-1826	12.4:1	0.08:1
$24C_6Cl_6 + 18H_2O + C_6H_3(CH_3)_3 \Rightarrow 24C_6H_1Cl_5 + 9CO_2 + 24H^+ + 24Cl^-$ <i>1,3,5-TMB oxidation/ Hexachlorobenzene reductive dehalogenation</i>	-541.84	-2265	56.4:1	0.02:1
$24C_6H_1Cl_5 + 18H_2O + C_6H_3(CH_3)_3 \Rightarrow 24C_6H_2Cl_4 + 9CO_2 + 24H^+ + 24Cl^-$ <i>1,3,5-TMB oxidation/ Pentachlorobenzene reductive dehalogenation</i>	-555.23	-2321	49.6:1	0.02:1
$24C_6H_2Cl_4 + 18H_2O + C_6H_3(CH_3)_3 \Rightarrow 24C_6H_3Cl_3 + 9CO_2 + 24H^+ + 24Cl^-$ <i>1,3,5-TMB oxidation/ Tetrachlorobenzene reductive dehalogenation</i>	-508.43	-2125	42.8:1	0.02:1
$24C_6H_3Cl_3 + 18H_2O + C_6H_3(CH_3)_3 \Rightarrow 24C_6H_4Cl_2 + 9CO_2 + 24H^+ + 24Cl^-$ <i>1,3,5-TMB oxidation/ Trichlorobenzene reductive dehalogenation</i>	-486.35	-2033	36.0:1	0.03:1

Table B.3.7 Continued.

Coupled 1,2,4-Trimethylbenzene (1,2,4-TMB) Oxidation Reactions	ΔG°_r (kcal/ mole)	ΔG°_r (kJ/ mole)	Stoichiometric Mass Ratio of Electron Acceptor or Metabolic Byproduct to Primary Substrate	Mass of Primary Substrate Utilized per Mass of Electron Acceptor Utilized or Metabolic Byproduct Produced
$12O_2 + C_6H_3(CH_3)_3 \Rightarrow 9CO_2 + 6H_2O$ <i>1,2,4-TMB oxidation / aerobic respiration</i>	-1212.92	-5075	3.20:1	0.31:1
$9.6NO_3^- + 9.6H^+ + C_6H_3(CH_3)_3 \Rightarrow 9CO_2 + 10.8H_2O + 4.8N_{2,g}$ <i>1,2,4-TMB oxidation / denitrification</i>	-1229.56	-5144	4.96:1	0.20:1
$24MnO_2 + 48H^+ + C_6H_3(CH_3)_3 \Rightarrow 9CO_2 + 30H_2O + 24Mn^{2+}$ <i>1,2,4-TMB oxidation / manganese reduction</i>	-1213.09	-5076	17.4:1	0.06:1
$48Fe(OH)_{3,a} + 96H^+ + C_6H_3(CH_3)_3 \Rightarrow 9CO_2 + 48Fe^{2+} + 126H_2O$ <i>1,2,4-TMB oxidation / iron reduction</i>	-928.16	-3883	42.8:1	0.02:1
$6SO_4^{2-} + 12H^+ + C_6H_3(CH_3)_3 \Rightarrow 9CO_2 + 6H_2O + 6H_2S^o$ <i>1,2,4-TMB oxidation / sulfate reduction</i>	-192.50	-805.4	4.80:1	0.21:1
$6H_2O + C_6H_3(CH_3)_3 \Rightarrow 3CO_2 + 6CH_4$ <i>1,2,4-TMB oxidation / methanogenesis</i>	-40.02	-167.4	0.90:1	1.11:1
$24C_2H_2Cl_4 + 18H_2O + C_6H_3(CH_3)_3 \Rightarrow 24C_2H_3Cl_3 + 9CO_2 + 24H^+ + 24Cl^-$ <i>1,2,4-TMB oxidation/ PCA reductive dehalogenation</i>	-507.36	-2121	33.2:1	0.03:1
$24C_2H_3Cl_3 + 18H_2O + C_6H_3(CH_3)_3 \Rightarrow 24C_2H_4Cl_2 + 9CO_2 + 24H^+ + 24Cl^-$ <i>1,2,4-TMB oxidation/ TCA reductive dehalogenation</i>	-584.62	-2444	26.4:1	0.04:1
$24C_2H_4Cl_2 + 18H_2O + C_6H_3(CH_3)_3 \Rightarrow 24C_2H_5Cl + 9CO_2 + 24H^+ + 24Cl^-$ <i>1,2,4-TMB oxidation/ DCA reductive dehalogenation</i>	-528.22	-2208	19.6:1	0.05:1
$24C_2Cl_4 + 18H_2O + C_6H_3(CH_3)_3 \Rightarrow 24C_2HCl_3 + 9CO_2 + 24H^+ + 24Cl^-$ <i>1,2,4-TMB oxidation/ PCE reductive dehalogenation</i>	-562.11	-2352	33.2:1	0.03:1
$24C_2HCl_3 + 18H_2O + C_6H_3(CH_3)_3 \Rightarrow 24C_2H_2Cl_2 + 9CO_2 + 24H^+ + 24Cl^-$ <i>1,2,4-TMB oxidation/ TCE reductive dehalogenation</i>	-548.43	-2295	26.3:1	0.04:1
$24C_2H_2Cl_2 + 18H_2O + C_6H_3(CH_3)_3 \Rightarrow 24C_2H_3Cl + 9CO_2 + 24H^+ + 24Cl^-$ <i>1,2,4-TMB oxidation/ cis-DCE reductive dehalogenation</i>	-434.19	-1817	19.4:1	0.05:1
$24C_2H_3Cl + 18H_2O + C_6H_3(CH_3)_3 \Rightarrow 24C_2H_4 + 9CO_2 + 24H^+ + 24Cl^-$ <i>1,2,4-TMB oxidation/ Vinyl chloride reductive dehalogenation</i>	-436.54	-1825	12.4:1	0.08:1
$24C_6Cl_6 + 18H_2O + C_6H_3(CH_3)_3 \Rightarrow 24C_6H_1Cl_5 + 9CO_2 + 24H^+ + 24Cl^-$ <i>1,2,4-TMB oxidation/ Hexachlorobenzene reductive dehalogenation</i>	-541.47	-2263	56.4:1	0.02:1
$24C_6H_1Cl_5 + 18H_2O + C_6H_3(CH_3)_3 \Rightarrow 24C_6H_2Cl_4 + 9CO_2 + 24H^+ + 24Cl^-$ <i>1,2,4-TMB oxidation/ Pentachlorobenzene reductive dehalogenation</i>	-554.86	-2319	49.6:1	0.02:1
$24C_6H_2Cl_4 + 18H_2O + C_6H_3(CH_3)_3 \Rightarrow 24C_6H_3Cl_3 + 9CO_2 + 24H^+ + 24Cl^-$ <i>1,2,4-TMB oxidation/ Tetrachlorobenzene reductive dehalogenation</i>	-508.06	-2124	42.8:1	0.02:1
$24C_6H_3Cl_3 + 18H_2O + C_6H_3(CH_3)_3 \Rightarrow 24C_6H_4Cl_2 + 9CO_2 + 24H^+ + 24Cl^-$ <i>1,2,4-TMB oxidation/ Trichlorobenzene reductive dehalogenation</i>	-485.98	-2031	36.0:1	0.03:1

Table B.3.7 Continued.

Coupled Vinyl Chloride Oxidation Reactions	ΔG°_r (kcal/ mole)	ΔG°_r (kJ/ mole)	Stoichiometric Mass Ratio of Electron Acceptor or Metabolic Byproduct to Primary Substrate	Mass of Primary Substrate Utilized per Mass of Electron Acceptor Utilized or Metabolic Byproduct Produced
$2.5O_2 + C_2H_3Cl \Rightarrow 2CO_2 + H_2O + H^+ + Cl^-$ <i>Vinyl Chloride oxidation /aerobic respiration</i>	-288.98	-1209	1.29:1	0.78:1
$2NO_3^- + H^+ + C_2H_3Cl \Rightarrow 2CO_2 + 2H_2O + Cl^- + N_{2,g}$ <i>Vinyl Chloride oxidation / denitrification</i>	-292.44	-1224	2.00:1	0.50:1
$5MnO_2 + 9H^+ + C_2H_3Cl \Rightarrow 2CO_2 + 6H_2O + 5Mn^{2+} + Cl^-$ <i>Vinyl Chloride oxidation / manganese reduction</i>	-289.01	-1209	7.02:1	0.14:1
$10Fe(OH)_{3,a} + 19H^+ + C_6H_3(CH_3)_3 \Rightarrow 2CO_2 + 10Fe^{2+} + 26H_2O + Cl^-$ <i>Vinyl Chloride oxidation / iron reduction</i>	-229.65	-960.9	17.3:1	0.06:1
$1.25SO_4^{2-} + 1.5H^+ + C_2H_3Cl \Rightarrow 2CO_2 + H_2O + 1.25H_2S^0 + Cl^-$ <i>Vinyl Chloride oxidation / sulfate reduction</i>	-76.40	-319.7	1.94:1	0.52:1
$1.5H_2O + C_2H_3Cl \Rightarrow .75CO_2 + 1.25CH_4 + H^+ + Cl^-$ <i>Vinyl Chloride oxidation / methanogenesis</i>	-44.62	-186.7	0.44:1	2.27:1
$5C_2H_2Cl_4 + 4H_2O + C_2H_3Cl \Rightarrow 5C_2H_3Cl_3 + 2CO_2 + 6H^+ + 6Cl^-$ <i>Vinyl Chloride oxidation/ PCA reductive dehalogenation</i>	-141.90	-593.1	13.4:1	0.07:1
$5C_2H_3Cl_3 + 4H_2O + C_2H_3Cl \Rightarrow 5C_2H_4Cl_2 + 2CO_2 + 6H^+ + 6Cl^-$ <i>Vinyl Chloride oxidation/ TCA reductive dehalogenation</i>	-158.08	-661	10.7:1	0.09:1
$5C_2H_4Cl_2 + 4H_2O + C_2H_3Cl \Rightarrow 5C_2H_5Cl + 2CO_2 + 6H^+ + 6Cl^-$ <i>Vinyl Chloride oxidation/ DCA reductive dehalogenation</i>	-146.33	-612	7.92:1	0.13:1
$5C_2Cl_4 + 4H_2O + C_2H_3Cl \Rightarrow 5C_2HCl_3 + 2CO_2 + 6H^+ + 6Cl^-$ <i>Vinyl Chloride oxidation/ DCE reductive dehalogenation</i>	-153.39	-641.8	13.4:1	0.07:1
$5C_2HCl_3 + 4H_2O + C_2H_3Cl \Rightarrow 5C_2H_2Cl_2 + 2CO_2 + 6H^+ + 6Cl^-$ <i>Vinyl Chloride oxidation/ TCE reductive dehalogenation</i>	-150.54	-629.9	10.6:1	0.09:1
$5C_2H_2Cl_2 + 4H_2O + C_2H_3Cl \Rightarrow 5C_2H_3Cl + 2CO_2 + 6H^+ + 6Cl^-$ <i>Vinyl Chloride oxidation/ cis-DCE reductive dehalogenation</i>	-126.74	-530.3	7.82:1	0.13:1
$5C_6Cl_6 + 4H_2O + C_2H_3Cl \Rightarrow 5C_6H_1Cl_5 + 2CO_2 + 6H^+ + 6Cl^-$ <i>Vinyl Chloride oxidation/ Hexachlorobenzene reductive dehalogenation</i>	-144.60	-604.4	22.8:1	0.04:1
$5C_6H_1Cl_5 + 4H_2O + C_2H_3Cl \Rightarrow 5C_6H_2Cl_4 + 2CO_2 + 6H^+ + 6Cl^-$ <i>Vinyl Chloride oxidation/ Pentachlorobenzene reductive dehalogenation</i>	-138.59	-579.3	20.0:1	0.05:1
$5C_6H_2Cl_4 + 4H_2O + C_2H_3Cl \Rightarrow 5C_6H_3Cl_3 + 2CO_2 + 6H^+ + 6Cl^-$ <i>Vinyl Chloride oxidation/ Tetrachlorobenzene reductive dehalogenation</i>	-142.13	-594.1	17.3:1	0.06:1
$5C_6H_3Cl_3 + 4H_2O + C_2H_3Cl \Rightarrow 5C_6H_4Cl_2 + 2CO_2 + 6H^+ + 6Cl^-$ <i>Vinyl Chloride oxidation/ Trichlorobenzene reductive dehalogenation</i>	-137.53	-574.9	14.5:1	0.07:1
$2O_2 + C_2H_2Cl_2 \Rightarrow 2CO_2 + 2H^+ + 2Cl^-$ <i>DCE oxidation /aerobic respiration</i>	-256.53	-1072	1.31:1	0.76:1

Table B.3.7 Continued.

Coupled Chlorobenzene Oxidation Reactions	ΔG°_r (kcal/ mole)	ΔG°_r (kJ/ mole)	Stoichiometric Mass Ratio of Electron Acceptor or Metabolic Byproduct to Primary Substrate	Mass of Primary Substrate Utilized per Mass of Electron Acceptor Utilized or Metabolic Byproduct Produced
$7O_2 + C_6H_4Cl \Rightarrow 6CO_2 + H^+ + 2H_2O + Cl^-$ <i>Chlorobenzene oxidation / aerobic respiration</i>	-731.62	-3061	2.00:1	0.50:1
$5.6NO_3^- + 4.6H^+ + C_6H_4Cl \Rightarrow 6CO_2 + 4.8H_2O + 2.8N_{2,g} + 2Cl^-$ <i>Chlorobenzene oxidation / denitrification</i>	-741.33	-3102	3.10:1	0.32:1
$14MnO_2 + 27H^+ + C_6H_5Cl \Rightarrow 6CO_2 + 16H_2O + 14Mn^{2+} + Cl^-$ <i>Chlorobenzene oxidation / manganese reduction</i>	-731.72	-3062	10.9:1	0.09:1
$28Fe(OH)_{3,a} + 55H^+ + C_6H_5Cl \Rightarrow 6CO_2 + 72H_2O + 28Fe^{2+} + Cl^-$ <i>Chlorobenzene oxidation / iron reduction</i>	-565.51	-2366	26.8:1	0.04:1
$3.5SO_4^{2-} + 6H^+ + C_6H_5Cl \Rightarrow 6CO_2 + 2H_2O + 3.5H_2S^0 + Cl^-$ <i>Chlorobenzene oxidation / sulfate reduction</i>	-136.38	-570.6	3.00:1	0.33:1
$5H_2O + C_6H_5Cl \Rightarrow 2.5CO_2 + 3.5CH_4 + H^+ + Cl^-$ <i>Chlorobenzene oxidation / methanogenesis</i>	-47.43	-198.4	0.80:1	1.25:1
$14C_2H_2Cl_4 + 12H_2O + C_6H_5Cl \Rightarrow 14C_2H_3Cl_3 + 6CO_2 + 15H^+ + 15Cl^-$ <i>Chlorobenzene oxidation/ PCA reductive dehalogenation</i>	-320.04	-1338	20.8:1	0.05:1
$14C_2H_3Cl_3 + 12H_2O + C_6H_5Cl \Rightarrow 14C_2H_4Cl_2 + 6CO_2 + 15H^+ + 15Cl^-$ <i>Chlorobenzene oxidation/ TCA reductive dehalogenation</i>	-365.11	-1526	16.5:1	0.06:1
$14C_2H_4Cl_2 + 12H_2O + C_6H_5Cl \Rightarrow 14C_2H_5Cl + 6CO_2 + 15H^+ + 15Cl^-$ <i>Chlorobenzene oxidation/ DCA reductive dehalogenation</i>	-332.21	-1389	12.3:1	0.08:1
$14C_2Cl_4 + 12H_2O + C_6H_5Cl \Rightarrow 14C_2HCl_3 + 6CO_2 + 15H^+ + 15Cl^-$ <i>Chlorobenzene oxidation/ PCE reductive dehalogenation</i>	-351.99	-1473	20.7:1	0.05:1
$14C_2HCl_3 + 12H_2O + C_6H_5Cl \Rightarrow 14C_2H_2Cl_2 + 6CO_2 + 15H^+ + 15Cl^-$ <i>Chlorobenzene oxidation/ TCE reductive dehalogenation</i>	-344.01	-1439	16.4:1	0.06:1
$14C_2H_2Cl_2 + 12H_2O + C_6H_5Cl \Rightarrow 14C_2H_3Cl + 6CO_2 + 15H^+ + 15Cl^-$ <i>Chlorobenzene oxidation/ cis-DCE reductive dehalogenation</i>	-277.37	-1161	12.1:1	0.08:1
$14C_2H_3Cl + 12H_2O + C_6H_5Cl \Rightarrow 14C_2H_4 + 6CO_2 + 15H^+ + 15Cl^-$ <i>Chlorobenzene oxidation/ Vinyl chloride reductive dehalogenation</i>	-278.73	-1165	7.75:1	0.13:1

Table B.3.7 Continued.

Coupled Dichlorobenzene Oxidation Reactions	ΔG°_r (kcal/ mole)	ΔG°_r (kJ/ mole)	Stoichiometric Mass Ratio of Electron Acceptor or Metabolic Byproduct to Primary Substrate	Mass of Primary Substrate Utilized per Mass of Electron Acceptor Utilized or Metabolic Byproduct Produced
$6.5O_2 + C_6H_4Cl_2 \Rightarrow 6CO_2 + 2H^+ + H_2O + 2Cl^-$ <i>Dichlorobenzene oxidation /aerobic respiration</i>	-698.36	-2919	1.42:1	0.70:1
$5.2NO_3^- + 3.2H^+ + C_6H_4Cl_2 \Rightarrow 6CO_2 + 3.6H_2O + 2.6N_2,g + 2Cl^-$ <i>Dichlorobenzene oxidation / denitrification</i>	-708.76	-2963	1.64:1	0.61:1
$13MnO_2 + 24H^+ + C_6H_4Cl_2 \Rightarrow 6CO_2 + 14H_2O + 13Mn^{2+} + 2Cl^-$ <i>Dichlorobenzene oxidation / manganese reduction</i>	-698.36	-2919	7.75:1	0.13:1
$26Fe(OH)_{3,a} + 50H^+ + C_6H_4Cl_2 \Rightarrow 6CO_2 + 66H_2O + 26Fe^{2+} + 2Cl^-$ <i>Dichlorobenzene oxidation / iron reduction</i>	-521.56	-2180	19.05:1	0.05:1
$3.25SO_4^{2-} + 4.5H^+ + C_6H_4Cl_2 \Rightarrow 6CO_2 + H_2O + 3.25H_2S^0 + 2Cl^-$ <i>Dichlorobenzene oxidation / sulfate reduction</i>	-142.74	-596.7	2.14:1	0.47:1
$5.5H_2O + C_6H_4Cl_2 \Rightarrow 2.75CO_2 + 3.25CH_4 + 2H^+ + 2Cl^-$ <i>Dichlorobenzene oxidation / methanogenesis</i>	-64.22	-268.4	0.33:1	2.99:1
$13C_2H_2Cl_4 + 12H_2O + C_6H_4Cl_2 \Rightarrow 13C_2H_3Cl_3 + 6CO_2 + 15H^+ + 15Cl^-$ <i>Dichlorobenzene oxidation/ PCA reductive dehalogenation</i>	-317.20	-1326	14.8:1	0.07:1
$13C_2H_3Cl_3 + 12H_2O + C_6H_4Cl_2 \Rightarrow 13C_2H_4Cl_2 + 6CO_2 + 15H^+ + 15Cl^-$ <i>Dichlorobenzene oxidation/ TCA reductive dehalogenation</i>	-358.93	-1500	11.8:1	0.09:1
$13C_2H_4Cl_2 + 12H_2O + C_6H_4Cl_2 \Rightarrow 13C_2H_5Cl + 6CO_2 + 15H^+ + 15Cl^-$ <i>Dichlorobenzene oxidation/ DCA reductive dehalogenation</i>	-328.38	-1373	8.73:1	0.11:1
$13C_2Cl_4 + 12H_2O + C_6H_4Cl_2 \Rightarrow 13C_2HCl_3 + 6CO_2 + 15H^+ + 15Cl^-$ <i>Dichlorobenzene oxidation/ PCE reductive dehalogenation</i>	-347.10	-1450	14.6:1	0.07:1
$13C_2HCl_3 + 12H_2O + C_6H_4Cl_2 \Rightarrow 13C_2H_2Cl_2 + 6CO_2 + 15H^+ + 15Cl^-$ <i>Dichlorobenzene oxidation/ TCE reductive dehalogenation</i>	-339.56	-1419	11.6:1	0.09:1
$13C_2H_2Cl_2 + 12H_2O + C_6H_4Cl_2 \Rightarrow 13C_2H_3Cl + 6CO_2 + 15H^+ + 15Cl^-$ <i>Dichlorobenzene oxidation/ cis-DCE reductive dehalogenation</i>	-277.68	-1161	8.55:1	0.12:1
$13C_2H_3Cl + 12H_2O + C_6H_4Cl_2 \Rightarrow 13C_2H_4 + 6CO_2 + 15H^+ + 15Cl^-$ <i>Dichlorobenzene oxidation/ Vinyl chloride reductive dehalogenation</i>	-278.72	-1165	5.52:1	0.18:1

Table B.3.7 Continued.

Coupled Trichlorobenzene Oxidation Reactions	ΔG°_r (kcal/ mole)	ΔG°_r (kJ/ mole)	Stoichiometric Mass Ratio of Electron Acceptor or Metabolic Byproduct to Primary Substrate	Mass of Primary Substrate Utilized per Mass of Electron Acceptor Utilized or Metabolic Byproduct Produced
$6O_2 + C_6H_3Cl_3 \Rightarrow 6CO_2 + 3H^+ + 3Cl^-$ <i>Trichlorobenzene oxidation / aerobic respiration</i>	-668.16	-2793	1.07:1	0.94:1
$4.8NO_3^- + 1.8H^+ + C_6H_3Cl_3 \Rightarrow 6CO_2 + 2.4H_2O + 2.4N_{2,g} + 3Cl^-$ <i>Trichlorobenzene oxidation / denitrification</i>	-677.76	-2833	1.65:1	0.60:1
$12MnO_2 + 21H^+ + C_6H_3Cl_3 \Rightarrow 6CO_2 + 12H_2O + 12Mn^{2+} + 3Cl^-$ <i>Trichlorobenzene oxidation / manganese reduction</i>	-688.16	-2793	5.80:1	0.17:1
$24Fe(OH)_3,a + 45H^+ + C_6H_3Cl_3 \Rightarrow 6CO_2 + 60H_2O + 24Fe^{2+} + 3Cl^-$ <i>Trichlorobenzene oxidation / iron reduction</i>	-504.96	-2111	14.3:1	0.07:1
$3SO_4^{2-} + 3H^+ + C_6H_3Cl_3 \Rightarrow 6CO_2 + 3H_2S^o + 3Cl^-$ <i>Trichlorobenzene oxidation / sulfate reduction</i>	-155.28	-649.1	1.60:1	0.63:1
$6H_2O + C_6H_3Cl_3 \Rightarrow 3CO_2 + 3CH_4 + 3H^+ + 3Cl^-$ <i>Trichlorobenzene oxidation / methanogenesis</i>	-82.80	-346.1	0.25:1	4.00:1
$12C_2H_2Cl_4 + 12H_2O + C_6H_3Cl_3 \Rightarrow 12C_2H_3Cl_3 + 6CO_2 + 15H^+ + 15Cl^-$ <i>Trichlorobenzene oxidation/ PCA reductive dehalogenation</i>	-316.32	-1322	11.1:1	0.09:1
$12C_2H_3Cl_3 + 12H_2O + C_6H_3Cl_3 \Rightarrow 12C_2H_4Cl_2 + 6CO_2 + 15H^+ + 15Cl^-$ <i>Trichlorobenzene oxidation/ TCA reductive dehalogenation</i>	-354.82	-1483	8.8:1	0.11:1
$12C_2H_4Cl_2 + 12H_2O + C_6H_3Cl_3 \Rightarrow 12C_2H_5Cl + 6CO_2 + 15H^+ + 15Cl^-$ <i>Trichlorobenzene oxidation/ DCA reductive dehalogenation</i>	-326.62	-1365	6.53:1	0.15:1
$12C_2Cl_4 + 12H_2O + C_6H_3Cl_3 \Rightarrow 12C_2HCl_3 + 6CO_2 + 15H^+ + 15Cl^-$ <i>Trichlorobenzene oxidation/ PCE reductive dehalogenation</i>	-343.92	-1438	10.9:1	0.09:1
$12C_2HCl_3 + 12H_2O + C_6H_3Cl_3 \Rightarrow 12C_2H_2Cl_2 + 6CO_2 + 15H^+ + 15Cl^-$ <i>Trichlorobenzene oxidation/ TCE reductive dehalogenation</i>	-336.96	-1408	8.67:1	0.12:1
$12C_2H_2Cl_2 + 12H_2O + C_6H_3Cl_3 \Rightarrow 12C_2H_3Cl + 6CO_2 + 15H^+ + 15Cl^-$ <i>Trichlorobenzene oxidation/ cis-DCE reductive dehalogenation</i>	-279.58	-1169	6.40:1	0.16:1
$12C_2H_3Cl + 12H_2O + C_6H_3Cl_3 \Rightarrow 12C_2H_4 + 6CO_2 + 15H^+ + 15Cl^-$ <i>Trichlorobenzene oxidation/ Vinyl chloride reductive dehalogenation</i>	-280.78	-1174	4.13:1	0.24:1

Table B.3.7 Continued.

Coupled Tetrachlorobenzene Oxidation Reactions	ΔG°_r (kcal/ mole)	ΔG°_r (kJ/ mole)	Stoichiometric Mass Ratio of Electron Acceptor or Metabolic Byproduct to Primary Substrate	Mass of Primary Substrate Utilized per Mass of Electron Acceptor Utilized or Metabolic Byproduct Produced
$5.5O_2 + H_2O + C_6H_2Cl_4 \Rightarrow 6CO_2 + 4H^+ + 4Cl^-$ <i>Tetrachlorobenzene oxidation /aerobic respiration</i>	-639.10	-2671	0.82:1	1.22:1
$4.4NO_3^- + 0.4 H^+ + C_6H_2Cl_4 \Rightarrow 6CO_2 + 1.2H_2O + 2.2N_{2,g} + 4Cl^-$ <i>Tetrachlorobenzene oxidation / denitrification</i>	-647.90	-2708	1.27:	0.78:1
$11MnO_2 + 18H^+ + C_6H_2Cl_4 \Rightarrow 6CO_2 + 10H_2O + 11Mn^{2+} + 4Cl^-$ <i>Tetrachlorobenzeneoxidation / manganese reduction</i>	-639.10	-2671	4.47:1	0.22:1
$22Fe(OH)_{3,a} + 40H^+ + C_6H_2Cl_4 \Rightarrow 6CO_2 + 54H_2O + 22Fe^{2+} + 4Cl^-$ <i>Tetrachlorobenzene oxidation / iron reduction</i>	-489.50	-2046	11.0:1	0.09:1
$2.75SO_4^{2-} + 1.75H^+ + H_2O + C_6H_2Cl_4 \Rightarrow 6CO_2 + 2.75H_2S^o + 4Cl^-$ <i>Tetrachlorobenzene oxidation / sulfate reduction</i>	-168.96	-706.3	1.23:1	0.81:1
$6.5H_2O + C_6H_2Cl_4 \Rightarrow 3.25CO_2 + 2.75CH_4 + 4H^+ + 4Cl^-$ <i>Tetrachlorobenzene oxidation / methanogenesis</i>	-102.52	-428.5	0.19:1	5.19:1
$11C_2H_2Cl_4 + 12H_2O + C_6H_2Cl_4 \Rightarrow 11C_2H_3Cl_3 + 6CO_2 + 15H^+ + 15Cl^-$ <i>Tetrachlorobenzene oxidation/ PCA reductive dehalogenation</i>	-287.01	-1200	8.53:1	0.12:1
$11C_2H_3Cl_3 + 12H_2O + C_6H_2Cl_4 \Rightarrow 11C_2H_4Cl_2 + 6CO_2 + 15H^+ + 15Cl^-$ <i>Tetrachlorobenzene oxidation/ TCA reductive dehalogenation</i>	-323.64	-1353	6.79:1	0.15:1
$11C_2H_4Cl_2 + 12H_2O + C_6H_2Cl_4 \Rightarrow 11C_2H_3Cl + 6CO_2 + 15H^+ + 15Cl^-$ <i>Tetrachlorobenzene oxidation/ DCA reductive dehalogenation</i>	-297.79	-1392	5.04:1	0.20:1
$11C_2Cl_4 + 12H_2O + C_6H_2Cl_4 \Rightarrow 11C_2HCl_3 + 6CO_2 + 15H^+ + 15Cl^-$ <i>Tetrachlorobenzene oxidation/ PCE reductive dehalogenation</i>	-313.3	-1310	8.43:1	0.12:1
$11C_2HCl_3 + 12H_2O + C_6H_2Cl_4 \Rightarrow 11C_2H_2Cl_2 + 6CO_2 + 15H^+ + 15Cl^-$ <i>Tetrachlorobenzene oxidation/ TCE reductive dehalogenation</i>	-307.03	-1283	6.68:1	0.15:1
$11C_2H_2Cl_2 + 12H_2O + C_6H_2Cl_4 \Rightarrow 11C_2H_3Cl + 6CO_2 + 15H^+ + 15Cl^-$ <i>Tetrachlorobenzene oxidation/ cis-DCE reductive dehalogenation</i>	-254.67	-1065	4.93:1	0.20:1
$11C_2H_3Cl + 12H_2O + C_6H_2Cl_4 \Rightarrow 11C_2H_4 + 6CO_2 + 15H^+ + 15Cl^-$ <i>Tetrachlorobenzene oxidation/ Vinyl chloride reductive dehalogenation</i>	-255.77	-1069	3.19:1	0.31:1

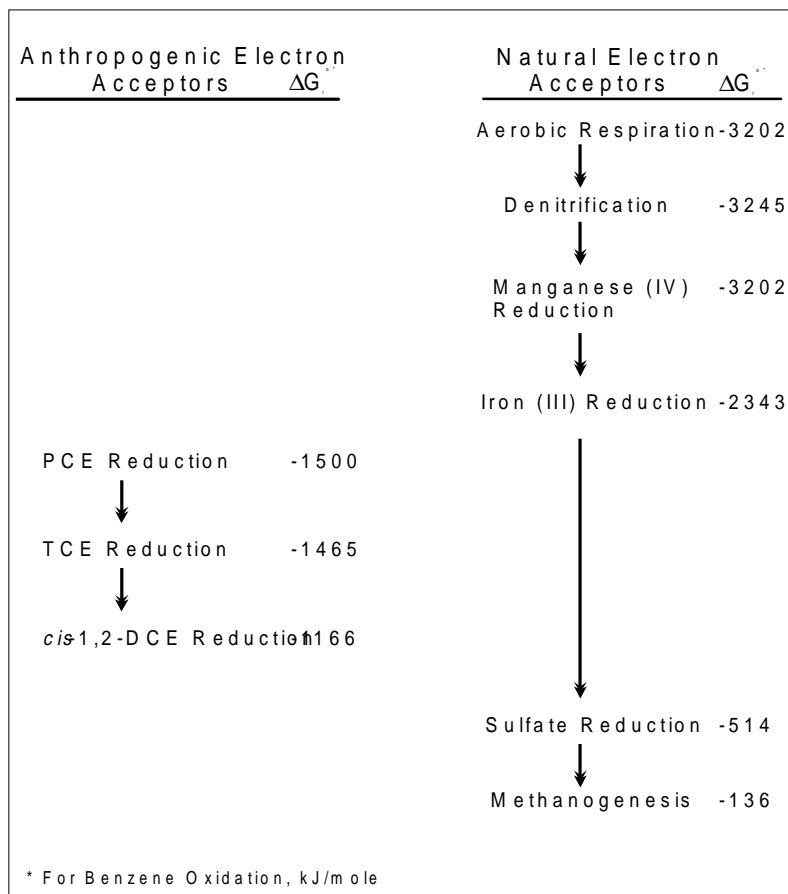

Figure B.3.4 Expected sequence of microbially-mediated redox reactions and Gibbs free energy of reaction.

B.3.6 ONE-DIMENSIONAL ADVECTION-DISPERSION EQUATION WITH RETARDATION AND BIODEGRADATION

The advection-dispersion equation is obtained by adding a biodegradation term to equation B.2.20. In one dimension, this is expressed as:

$$\frac{\partial C}{\partial t} = \frac{D_x}{R} \frac{\partial^2 C}{\partial x^2} - \frac{v_x}{R} \frac{\partial C}{\partial x} - \lambda C \quad \text{eq. B.3.2}$$

Where:

v_x = average linear ground-water velocity [L/T]

R = coefficient of retardation

C = contaminant concentration [M/L³]

D_x = hydrodynamic dispersion [L²/T]

t = time [T]

x = distance along flow path [L]

λ = first-order biodegradation decay rate [T⁻¹]

This equation considers advection, hydrodynamic dispersion, sorption (retardation), and biodegradation. First-order rate constants are appropriate for iron (III)-reducing, sulfate-reducing, and methanogenic conditions. They are not appropriate under aerobic or denitrifying conditions.

SECTION B-4

DESTRUCTIVE ATTENUATION MECHANISMS - ABIOTIC

Chlorinated solvents dissolved in ground water may also be degraded by abiotic mechanisms, although the reactions are typically not complete and often result in the formation of an intermediate that may be at least as toxic as the original contaminant. The most common reactions affecting chlorinated compounds are hydrolysis (a substitution reaction) and dehydrohalogenation (an elimination reaction). Other possible reactions include oxidation and reduction reactions. Butler and Barker (1996) note that no abiotic oxidation reactions involving typical halogenated solvents have been reported in the literature. They also note that reduction reactions (which include hydrogenolysis and dihaloelimination) are commonly microbially mediated, although some abiotic reduction reactions have been observed.

As Butler and Barker (1996) note, attributing changes in either the presence or absence of halogenated solvents or the concentrations of halogenated solvents to abiotic processes is usually difficult. For example, microbial activity is generally required to produce reducing conditions that favor reductive dehalogenation. If such activity is taking place, chlorinated solvents may be undergoing both biotic and abiotic degradation, and discerning the relative contribution of each mechanism on the field scale, if possible, would be very difficult. As another example, Butler and Barker (1996) note that to substantiate that hydrolysis is occurring, the presence of non-halogenated breakdown products such as acids and alcohols should be established. In general, these products are more easily biodegraded than their parent compounds and can be difficult to detect. Field evidence of this nature has yet to be collected to demonstrate hydrolysis of halogenated solvents (Butler and Barker, 1996).

Given the difficulties of demonstrating abiotic degradation on the field scale, it may not be practical to demonstrate that such processes are occurring and to quantitatively evaluate the contributions of those reactions (i.e., separately from biotic processes). If biodegradation is occurring at a site, the loss of contaminant mass due to that process may dwarf the mass lost to abiotic reactions, ruling out a cost-effective evaluation of abiotic degradation. However, while the rates of abiotic degradation may be slow relative to biotic mechanisms, the contribution of these mechanisms may still play a significant role in natural attenuation, depending on site conditions (e.g., a site with a slow solute transport velocity or a long distance to the nearest receptor). Vogel (1994) describes data patterns that may result from varying combinations of biotic and abiotic degradation of chlorinated solvents. Moreover, because some of the by-products of these reactions are chlorinated compounds that may be more easily or less easily degraded than the parent, the contributions of abiotic mechanisms may need to be considered when evaluating analytical data from a site.

B.4.1 HYDROLYSIS AND DEHYDROHALOGENATION

As discussed by Butler and Barker (1996), hydrolysis and dehydrohalogenation reactions are the most thoroughly studied abiotic attenuation mechanisms. In general, the rates of these reactions are often quite slow within the range of normal ground-water temperatures, with half-lives of days to centuries (Vogel *et al.*, 1987; Vogel, 1994). Therefore, most information about the rates of these reactions is extrapolated from experiments run at higher temperatures so that the experiments could be performed within a practical time frame.

B.4.1.1 Hydrolysis

Hydrolysis is a substitution reaction in which an organic molecule reacts with water or a component ion of water, and a halogen substituent is replaced with a hydroxyl (OH⁻) group. The hydroxyl substitution typically occurs at the halogenated carbon. This leads initially to the production of alcohols. If the alcohols are halogenated, additional hydrolysis to acids or diols may occur. Also,

the addition of a hydroxyl group to a parent molecule may make the daughter product more susceptible to biodegradation, as well as more soluble (Neely, 1985). Non-alcohol products have also been reported by Vogel *et al.* (1987) and Jeffers *et al.* (1989), but they are apparently products of competing dehydrohalogenation reactions.

The likelihood that a halogenated solvent will undergo hydrolysis depends in part on the number of halogen substituents. More halogen substituents on a compound will decrease the chance for hydrolysis reactions to occur (Vogel *et al.*, 1987), and will therefore decrease the rate of the reaction. In addition, bromine substituents are more susceptible to hydrolysis than chlorine substituents (Vogel *et al.*, 1987). 1,2-Dibromoethane is one compound that is subject to significant hydrolysis reactions under natural conditions. Locations of the halogen substituent on the carbon chain may also have some effect on the rate of reaction. The rate also may increase with increasing pH; however, a rate dependence upon pH is typically not observed below a pH of 11 (Mabey and Mill, 1978; Vogel and Reinhard, 1986). Rates of hydrolysis may also be increased by the presence of clays, which can act as catalysts (Vogel *et al.*, 1987). Hydrolysis rates can generally be described using first-order kinetics, particularly in solutions in which water is the dominant nucleophile (Vogel *et al.*, 1987). However, this oversimplifies what is typically a much more complicated relationship (Neely, 1985). As noted in the introduction to this Appendix, reported rates of environmentally significant hydrolysis reactions involving chlorinated solvents are typically the result of extrapolation from experiments performed at higher temperatures (Mabey and Mill, 1978; Vogel, 1994).

Hydrolysis of chlorinated methanes and ethanes has been well-demonstrated in the literature. Vogel (1994) reports that monohalogenated alkanes have half-lives on the order of days to months, while polychlorinated methanes and ethanes have half-lives that may range up to thousands of years for carbon tetrachloride. As the number of chlorine atoms increases, dehydrohalogenation may become more important (Jeffers *et al.*, 1989). Butler and Barker (1996) note that chlorinated ethenes do not undergo significant hydrolysis reactions (i.e., the rates are slow). Butler and Barker also reported that they were unable to find any studies on hydrolysis of vinyl chloride. A listing of half-lives for abiotic hydrolysis and dehydrohalogenation of some chlorinated solvents is presented on Table B.4.1. Note that no distinctions are made in the table as to which mechanism is operating; this is consistent with the references from which the table has been derived (Vogel *et al.*, 1987; Butler and Barker, 1996).

One common chlorinated solvent for which abiotic transformations have been well-studied is 1,1,1-TCA. 1,1,1-TCA may be abiotically transformed to acetic acid through a series of substitution reactions, including hydrolysis. In addition, 1,1,1-TCA may be reductively dehalogenated to form 1,1-DCA and then chloroethane (CA), which is then hydrolyzed to ethanol (Vogel and McCarty, 1987) or dehydrohalogenated to vinyl chloride (Jeffers *et al.*, 1989). Rates of these reactions have been studied by several parties, and these rates are summarized in Table B.4.1.

B.4.1.2 Dehydrohalogenation

Dehydrohalogenation is an elimination reaction involving halogenated alkanes in which a halogen is removed from one carbon atom, followed by the subsequent removal of a hydrogen atom from an adjacent carbon atom. In this two-step reaction, an alkene is produced. Although the oxidation state of the compound decreases due to the removal of a halogen, the loss of a hydrogen atom increases it. This results in no external electron transfer, and there is no net change in the oxidation state of the reacting molecule (Vogel *et al.*, 1987). Contrary to the patterns observed for hydrolysis, the likelihood that dehydrohalogenation will occur increases with the number of halogen substituents. It has been suggested that under normal environmental conditions, monohalogenated aliphatics apparently do not undergo dehydrohalogenation, and these reactions are apparently not likely to occur (March, 1985; Vogel *et al.*, 1987). However, Jeffers *et al.* (1989) report on the

dehydrohalogenation of CA to VC. Polychlorinated alkanes have been observed to undergo dehydrohalogenation under normal conditions and extremely basic conditions (Vogel *et al.*, 1987). As with hydrolysis, bromine substituents are more reactive with respect to dehydrohalogenation.

Table B.4.1 Approximate Half-Lives of Abiotic Hydrolysis and Dehydrohalogenation Reactions Involving Chlorinated Solvents

Compound	Half-Life (years)	Products
Chloromethane	no data	
Methylene Chloride (Dichloromethane)	704 ^{a/}	
Trichloromethane (Chloroform)	3500 ^a , 1800 ^b	
Carbon Tetrachloride	41 ^b	
Chloroethane	0.12 ^c	ethanol
1,1-Dichloroethane	61 ^b	
1,2-Dichloroethane	72 ^b	
1,1,1-Trichloroethane	1.7 ^a , 1.1 ^b 2.5 ^d	acetic acid 1,1-DCE
1,1,2-Trichloroethane	140 ^b , 170 ^a	1,1-DCE
1,1,1,2-Tetrachloroethane	47 ^b , 380 ^a	TCE
1,1,2,2-Tetrachloroethane	0.3 ^e 0.4 ^b , 0.8 ^a	1,1,2-TCA TCE
Tetrachloroethene	0.7 ^f *, 1.3 x 10 ⁶ ^b	
Trichloroethene	0.7 ^f *, 1.3 x 10 ⁶ ^b	
1,1-Dichloroethene	1.2 x 10 ⁸ ^b	
1,2-Dichloroethene	2.1 x 10 ¹⁰ ^b	

^a From Mabey and Mill, 1978

^b From Jeffers *et al.*, 1989

^c From Vogel *et al.*, 1987

^d From Vogel and McCarty, 1987

^e From Cooper *et al.*, 1987

^f From Dilling *et al.*, 1975

* Butler and Barker (1996) indicate that these values may reflect experimental difficulties and that the longer half-life [as calculated by Jeffers *et al.* (1989)] should be used.

Dehydrohalogenation rates may also be approximated using pseudo-first-order kinetics. Once again, this is not truly a first-order reaction, but such approximations have been used in the literature to quantify the reaction rates. The rates will not only depend upon the number and types of halogen substituent, but also on the hydroxide ion concentration. Under normal pH conditions (i.e., near a

pH of 7), interaction with water (acting as a weak base) may become more important (Vogel *et al.*, 1987). Transformation rates for dehydrohalogenation reactions is presented in Table B.4.1. 1,1,1-TCA is also known to undergo dehydrohalogenation (Vogel and McCarty, 1987). In this case, TCA is transformed to 1,1-DCE, which is then reductively dehalogenated to VC. The VC is then either reductively dehalogenated to ethene or consumed as a substrate in an aerobic reaction and converted to CO₂. In a laboratory study, Vogel and McCarty (1987) reported that the abiotic conversion of 1,1,1-TCA to 1,1-DCE has a rate constant of about 0.04 year⁻¹. It was noted that this result was longer than indicated in previous studies, but that experimental methods differed. Jeffers *et al.* (1989) reported on several other dehydrohalogenation reactions; in addition to 1,1,1-TCA and 1,1,2-TCA both degrading to 1,1-DCE, the tetrachloroethanes and pentachloroethanes degrade to TCE and PCE, respectively. Rates of these reactions are included in Table B.4.1. As noted previously, Jeffers *et al.* (1989) also report that CA may degrade to VC, but no information on rates was encountered during the literature search for this Appendix.

B.4.2 REDUCTION REACTIONS

Two abiotic reductive dechlorination reactions that may operate in the subsurface are hydrogenolysis and dihaloelimination. Hydrogenolysis is the simple replacement of a chlorine (or another halogen) by a hydrogen, while dihaloelimination is the removal of two chlorines (or other halogens) accompanied by the formation of a double carbon-carbon bond. Butler and Barker (1996) review work by Criddle *et al.* (1986), Jafvert and Wolfe (1987), Reinhard *et al.* (1990), and Acton (1990) and this review suggests that while these reactions are thermodynamically possible under reducing conditions, they often do not take place in the absence of biological activity, even if such activity is only indirectly responsible for the reaction. While not involved in a manner similar to that for cometabolism, microbes may produce reductants that facilitate such reactions in conjunction with minerals in the aquifer matrix, as has been suggested by work utilizing aquifer material from the Borden test site (Reinhard *et al.*, 1990). Moreover, the reducing conditions necessary to produce such reactions are most often created as a result of microbial activity. It is therefore not clear if some of these reactions are truly abiotic, or if because of their reliance on microbial activity to produce reducing conditions or reactants, they should be considered to be a form of cometabolism.

In some cases, truly abiotic reductive dechlorination has been observed; however, the conditions that favor such reactions may not occur naturally. For example, Gillham and O'Hannesin (1994) describe reductive dehalogenation of chlorinated aliphatics using zero-valent iron, in which the iron serves as an electron donor in an electrochemical reaction. However, this is not a natural process. Wang and Tan (1990) reported reduction of TCE to ethene and carbon tetrachloride to methane during a platinum-catalyzed reaction between elemental magnesium and water. Given that the metals involved in these reactions are unlikely to occur naturally in the reduced forms used in the aforementioned work, such processes are not likely to contribute to natural attenuation of chlorinated solvents.

APPENDIX C

DATA INTERPRETATION and CALCULATIONS

TABLE OF CONTENTS - APPENDIX C

C-1	INTRODUCTION	C1-5
C-2	PREPARATION OF GEOLOGIC BORING LOGS, HYDROGEOLOGIC SECTIONS, AND MAPS	C2-6
C.2.1	PREPARATION OF LITHOLOGIC LOGS	C2-6
C.2.2	PREPARATION OF HYDROGEOLOGIC SECTIONS	C2-7
C.2.3	REVIEW OF TOPOGRAPHIC MAPS AND PREPARATION OF POTENTIOMETRIC SURFACE MAPS AND FLOW NETS	C2-7
C.2.3.1	Review of Topographic Maps	C2-7
C.2.3.2	Preparation of Potentiometric Surface Maps	C2-7
C.2.3.3	Preparation of Flow Nets	C2-9
C.2.3.4	Preparation of Contaminant Isopach Maps	C2-9
C.2.3.5	Preparation of Contaminant and Daughter Product Isopleth Maps	C2-14
C.2.3.6	Preparation of Electron Donor, Inorganic Electron Acceptor, and Metabolic By-product Contour (Isopleth) Maps	C2-15
C-3	NATURAL ATTENUATION CALCULATIONS	C3-18
C.3.1	CALCULATING HYDRAULIC PARAMETERS	C3-18
C.3.1.1	Hydraulic Conductivity	C3-18
C.3.1.2	Transmissivity	C3-20
C.3.1.3	Hydraulic Head and Gradient	C3-20
C.3.1.4	Total Porosity (n) and Effective Porosity (n_e)	C3-23
C.3.1.5	Linear Ground-water Flow Velocity (Seepage or Advective Velocity)	C3-24
C.3.1.6	Coefficient of Retardation and Retarded Contaminant Transport Velocity	C3-25
C.3.2	CONTAMINANT SOURCE TERM CALCULATIONS	C3-28
C.3.2.1	Direct Measurement of Dissolved Contaminant Concentrations in Ground Water in Contact with NAPL	C3-31
C.3.2.2	Equilibrium Partitioning Calculations	C3-32
C.3.2.3	Mass Flux Calculations	C3-33
C.3.3	CONFIRMING AND QUANTIFYING BIODEGRADATION	C3-37
C.3.3.1	Isopleth Maps	C3-37
C.3.3.2	Data Set Normalization	C3-37
C.3.3.3	Calculating Biodegradation Rates	C3-41
C.3.4	DESIGN, IMPLEMENTATION, AND INTERPRETATION OF MICROCOSM STUDIES	C3-49
C.3.4.1	Overview	C3-49
C.3.4.2	When to Use Microcosms	C3-50
C.3.4.3	Application of Microcosms	C3-50
C.3.4.4	Selecting Material for Study	C3-50
C.3.4.5	Geochemical Characterization of the Site	C3-51
C.3.4.6	Microcosm Construction	C3-54
C.3.4.7	Microcosm Interpretation	C3-54
C.3.4.8	The Tibbetts Road Case Study	C3-55
C.3.4.9	Summary	C3-58

FIGURES

No.	Title	Page
C.2.1	Example hydrogeologic section	C2-6
C.2.2	Example ground-water elevation map	C2-8
C.2.3	Example flow net	C2-9
C.2.4	Example mobile LNAPL isopach (A) and contaminant isopleth (B) maps	C2-10
C.2.5	Measured (apparent) <i>versus</i> actual LNAPL thickness	C2-11
C.2.6	Type curve for LNAPL baildown test	C2-14
C.2.7	Example isopleth maps of contaminants and soluble electron acceptors	C2-16
C.2.8	Example isopleth maps of contaminants and metabolic by-products	C2-17
C.3.1	Range of hydraulic conductivity values	C3-18
C.3.2	Hydraulic head	C3-21
C.3.3	Ground-water Elevation Map	C3-23
C.3.4	Location of sampling points at the St. Joseph, Michigan NPL site	C3-25
C.3.5	Field rate constants for TCE as reported in literature	C3-43
C.3.6	Field rate constants for PCE as reported in literature	C3-43
C.3.7	Field rate constants for Vinyl Chloride as reported in literature	C3-44
C.3.8	Exponential regression of TCE concentration on time of travel along flow path.....	C3-46
C.3.9	Regression of the TCE concentration on distance along flow path	C3-48
C.3.10	Tibbetts Road study site	C3-49
C.3.11	TCE microcosm results	C3-56
C.3.12	Benzene microcosm results	C3-56
C.3.13	Toluene microcosm results	C3-57

TABLES

No.	Title	Page
C.2.1	Typical Values for $h_{aw}^c _{dr}$	C2-12
C.2.2	Surface Tensions for Various Compounds	C2-13
C.2.3	Results of Example Baildown Test	C2-15
C.3.1	Representative Values of Hydraulic Conductivity for Various Sediments and Rocks	C3-19
C.3.2	Representative Values of Dry Bulk Density, Total Porosity, and Effective Porosity for Common Aquifer Matrix Materials	C3-24
C.3.3	Representative Values of Total Organic Carbon for Common Sediments	C3-27
C.3.4	Example Retardation Calculations for Select Compounds	C3-28
C.3.5	Attenuation of Chlorinated Ethenes and Chloride Downgradient of the Source of TCE in the West Plume at the St. Joseph, Michigan, NPL Site	C3-40
C.3.6	Use of the Attenuation of a Tracer to Correct the Concentration of TCE Downgradient of the Source of TCE in the West Plume at the St. Joseph, Michigan NPL Site	C3-41
C.3.7	Geochemical Parameters Important to Microcosm Studies	C3-53
C.3.8	Contaminants and Daughter Products	C3-53
C.3.9	Concentrations of TCE, Benzene, and Toluene in the Tibbetts Road Microcosms	C3-58
C.3.10	First-order Rate Constants for Removal of TCE, Benzene, and Toluene in the Tibbetts Road Microcosms	C3-59
C.3.11	Concentrations of Contaminants and Metabolic By-products in Monitoring Wells along Segments in the Plume used to Estimate Field-scale Rate Constants	C3-59
C.3.12	Comparison of First-order Rate for Contaminant Attenuation in Segments of the Tibbetts Road Plume	C3-60
C.3.13	Comparison of First-order Rate Constants in a Microcosm Study, and in the Field at the Tibbetts Road NPL Site	C3-60

SECTION C-1

INTRODUCTION

Successful documentation of natural attenuation requires interpretation of site-specific data to define the ground-water flow system, refine the conceptual model, quantify rates of contaminant attenuation, and model the fate and transport of dissolved contaminants. Tasks to be completed include preparation of lithologic logs, hydrogeologic sections, potentiometric surface maps and flow nets, contaminant isopach and isopleth maps, electron acceptor and metabolic byproduct isopleth maps, and calculation of hydraulic parameters, retardation coefficients, and biodegradation rate constants. The rate and amount of partitioning of organic compounds from mobile and residual nonaqueous-phase liquid (NAPL) into ground water should also be determined to allow estimation of a source term. Completion of these tasks permits refinement of the conceptual model and is necessary to successfully support remediation by natural attenuation.

This appendix consists of three sections, including this introduction. Section C-2 discusses preparation of geologic boring logs, hydrogeologic sections, and maps. Section C-3 covers natural attenuation calculations, including hydraulic parameter calculations, contaminant source term calculations, confirming and quantifying biodegradation, and designing, implementing, and interpreting microcosm studies.

SECTION C-2

PREPARATION OF GEOLOGIC BORING LOGS, HYDROGEOLOGIC SECTIONS, AND MAPS

The first step after completion of site characterization field activities is to prepare geologic boring logs, hydrogeologic sections, water table elevation (or potentiometric surface) maps, flow nets, and maps depicting contaminant concentrations, electron acceptor and metabolic byproduct concentrations, and mobile NAPL thickness. The construction of these items is discussed in the following sections.

C.2.1 PREPARATION OF LITHOLOGIC LOGS

Lithologic logs should be prepared using field data. Whenever possible, these logs should contain descriptions of the aquifer matrix, including relative density, color, major textural constituents, minor constituents, porosity, relative moisture content, plasticity of fines, cohesiveness, grain size, structure or stratification, relative permeability, and any significant observations such as visible fuel or fuel odor. It is also important to correlate the results of volatile organic compound (VOC) screening using headspace vapor analysis with depth intervals of geologic materials. The depth of lithologic contacts and/or significant textural changes should be recorded to the nearest 0.1 foot. This resolution is necessary because preferential flow and contaminant transport pathways may be limited to stratigraphic units less than 6 inches thick.

C.2.2 PREPARATION OF HYDROGEOLOGIC SECTIONS

Lithologic logs should be used in conjunction with water level data to prepare a minimum of two hydrogeologic sections for the site. One section should be oriented parallel to the direction of ground-water flow, and one section should be oriented perpendicular to the direction of ground-water flow. Both sections should be drawn to scale. Hydrogeologic sections are an integral part of the conceptual model and are useful in identifying preferential contaminant migration pathways and in modeling the site.

At a minimum, hydrogeologic sections should contain information on the relationships between hydrostratigraphic units at the site, including the location and distribution of transmissive vs. non-transmissive units, the location of the water table relative to these units, and the location(s) of the contaminant source(s). Figure C.2.1 is an example of a completed hydrogeologic section.

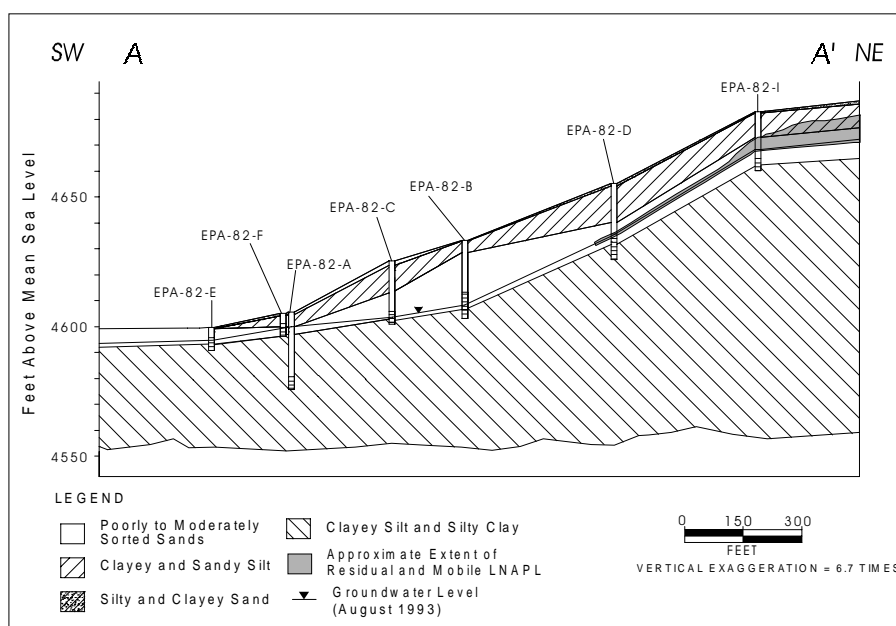

Figure C.2.1 Example hydrogeologic section.

C.2.3 REVIEW OF TOPOGRAPHIC MAPS AND PREPARATION OF POTENTIOMETRIC SURFACE MAPS AND FLOW NETS

Determining the direction of ground-water flow and the magnitude of hydraulic gradients is important because these parameters influence the direction and rate of contaminant migration. Ground-water flow directions are represented by a three-dimensional set of equipotential lines and orthogonal flow lines. If a plan view (potentiometric surface, or water table elevation, map) or a two-dimensional cross-section is drawn to represent a flow system, the resultant equipotential lines and flow lines constitute a flow net. A flow net can be used to determine the distribution of hydraulic head, the ground-water velocity distribution, ground-water and solute flow paths and flow rates, and the general flow pattern in a ground-water system.

C.2.3.1 Review of Topographic Maps

Ground-water flow is strongly influenced by the locations of ground-water divides and by recharge from and discharge to surface water bodies such as rivers, streams, lakes, and wetlands. Topographic highs generally represent divergent flow boundaries (divergent ground-water divide), and topographic lows such as valleys or drainage basins typically represent convergent flow boundaries (convergent ground-water divide). In addition, the configuration of the water table is typically a subtle reflection of the surface topography in the area. However, topography is not always indicative of subsurface flow patterns and should not be depended upon unless confirmed by head data. In order to place the local hydrogeologic flow system within the context of the regional hydrogeologic flow system, it is important to have an understanding of the local and regional topography. Included in this must be knowledge of the locations of natural and manmade surface water bodies. This information can generally be gained from topographic maps published by the United States Geological Survey.

C.2.3.2 Preparation of Potentiometric Surface Maps

A potentiometric surface map is a two-dimensional graphical representation of equipotential lines shown in plan view. Water table elevation maps are potentiometric surface maps drawn for water table (unconfined) aquifers. Potentiometric surface maps for water table aquifers show where planes of equal potential intersect the water table. A potentiometric surface map should be prepared from water level measurements and surveyor's data. These maps are used to estimate the direction of plume migration and to calculate hydraulic gradients. To document seasonal variations in ground-water flow, separate potentiometric surface maps should be prepared using quarterly water level measurements taken over a period of at least 1 year.

The data used to develop the potentiometric surface map should be water level elevation data (elevation relative to mean sea level) from piezometers/wells screened in the same relative position within the same hydrogeologic unit. For example, wells that are screened at the water table can be used for the same potentiometric surface map. Wells screened in different hydrogeologic units or at different relative positions within the same water table aquifer cannot be used to prepare a potentiometric surface map. Where possible, a potentiometric surface map should be prepared for each hydrogeologic unit at the site. In recharge areas, wells screened at various elevations cannot all be used to prepare the same potentiometric surface map because of strong downward vertical gradients. Likewise, wells screened at various elevations in discharge areas such as near streams, lakes, or springs, should not all be used because of the strong upward vertical gradients.

When preparing a potentiometric surface map, the locations of system boundaries should be kept in mind; particularly the site features that tend to offset the shape of the contours on the map. Such features include topographic divides, surface water bodies, and pumping wells.

In addition to, and separately from, preparation of a potentiometric surface map, water level measurements from wells screened at different depths can be used to determine any vertical hydrau-

lic gradients. It is important to have a good understanding of vertical hydraulic gradients because they may have a profound influence on contaminant migration.

In areas with measurable mobile LNAPL, a correction must be made for the water table deflection caused by the LNAPL. The following relationship, based on Archimedes' Principle, provides a correction factor that allows the water table elevation to be adjusted for the effect of floating LNAPL.

$$CDTW = MDTW - \frac{\rho_{lnapl}}{\rho_w} (PT) \quad \text{eq. C.2.1}$$

Where:

- $CDTW$ = corrected depth to water [L]
- $MDTW$ = measured depth to water [L]
- ρ_{lnapl} = density of the LNAPL [M/L^3]
- ρ_w = density of the water, generally 1.0 [M/L^3]
- PT = measured LNAPL thickness [L]

Using the corrected depth to water, the corrected ground-water elevation, CGWE, is given by:

$$CGWE = \text{Datum Elevation} - CDTW \quad \text{eq. C.2.2}$$

Corrected ground-water elevations should be used for potentiometric surface map preparation. Figure C.2.2 is an example of a ground-water elevation map for an unconfined aquifer. Water table elevation data used to prepare this map were taken from wells screened across the water table.

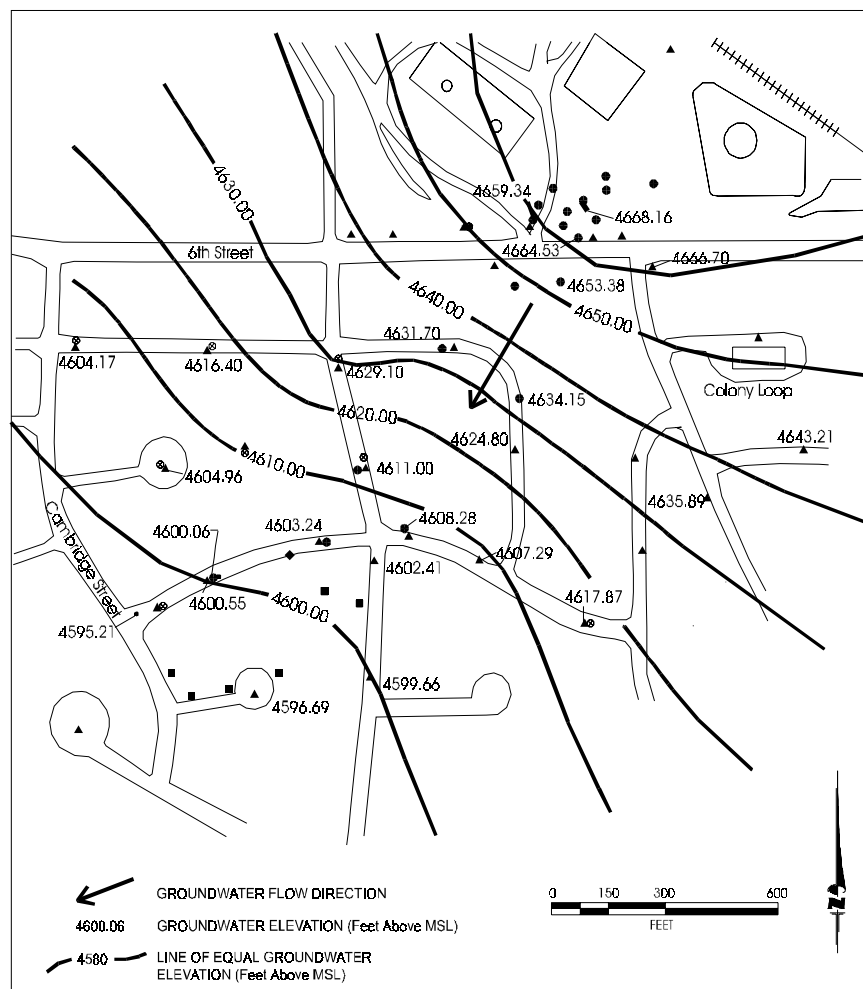

Figure C.2.2 Example ground-water elevation map.

C.2.3.3 Preparation of Flow Nets

Where an adequate three-dimensional database is available, flow nets can be constructed to facilitate the interpretation of the total hydraulic head distribution in the aquifer. This will help determine potential solute migration pathways. The simplest ground-water flow system is one that is homogeneous and isotropic. This type of hydrogeologic setting serves as a simple basis for describing the basic rules of flow net construction, despite the fact that homogeneous, isotropic media rarely occur in nature. Regardless of the type of geologic media, the basic rules of flow net construction must be applied, and necessary modifications must be made throughout the procedure to account for aquifer heterogeneity or anisotropic conditions. Water level data for flow net construction should come from multiple sets of nested wells (two or more wells at the same location) at various depths in the aquifer. The fundamental rules of flow net construction and the important properties of flow nets are summarized as follows:

- Flow lines and equipotential lines intersect at 90-degree angles if the permeability is isotropic;
- The geometric figures formed by the intersection of flow lines and equipotential lines must approximate squares or rectangles;
- Equipotential lines must meet impermeable boundaries at right angles (impermeable boundaries are flow lines); and
- Equipotential lines must be parallel to constant-head boundaries (constant-head boundaries are equipotential lines).

Trial-and-error sketching is generally used to construct a flow net. Flow net sketching can be sufficiently accurate if constructed according to the basic rules outlined above. A relatively small number of flow lines (three to five) generally are sufficient to adequately characterize flow conditions. Flow nets should be superimposed on the hydrogeologic sections. Figure C.2.3 is an example of a completed flow net. This figure shows ground-water flow patterns in both recharge and discharge areas.

C.2.3.4 Preparation of Contaminant Isopach Maps

If NAPL is present at the site, isopach maps showing the thickness and distribution of NAPL should be prepared. Two maps should be prepared: one for mobile NAPL, and one for residual NAPL. Such isopach maps allow estimation of the distribution of NAPL in the subsurface and aid in

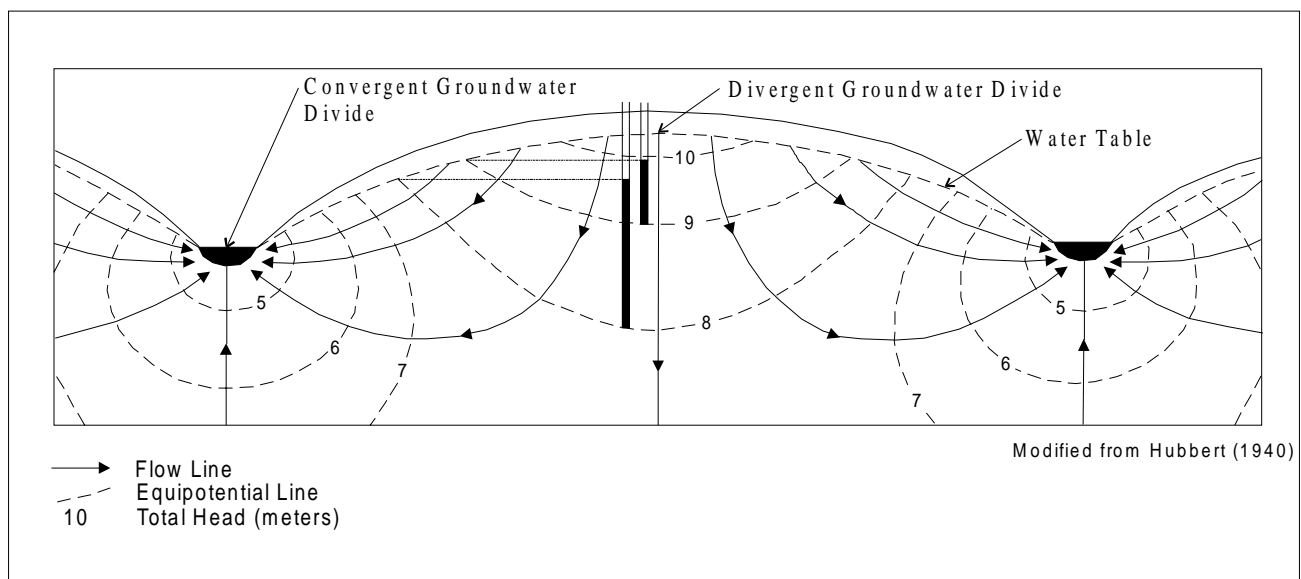

Figure C.2.3 Example flow net.

fate and transport model development by identifying the boundary of the NAPL. Because of the differences between the magnitude of capillary suction in the aquifer matrix and the different surface tension properties of fuel and water, LNAPL thickness observations made in monitoring points are only an estimate of the actual volume of mobile LNAPL in the aquifer. To determine the actual NAPL thickness it is necessary to collect and visually analyze soil samples. LNAPL thickness data also should be used to correct for water table deflections caused by the mobile LNAPL. This process is described in Section C.2.2.3.2.

Isopach maps are prepared by first plotting the measured NAPL thickness on a base map prepared using surveyor's data. Lines of equal NAPL thickness (isopachs) are then drawn and labeled. Each data point must be honored during contouring. Figure C.2.4 is an example of a completed isopach map. This figure also contains an example of an isopleth map.

C.2.3.4.1 Relationship Between Apparent and Actual LNAPL Thickness

It is well documented that LNAPL thickness measurements taken in ground-water monitoring wells are not indicative of actual LNAPL thicknesses in the formation (de Pastrovich *et al.*, 1979; Blake and Hall, 1984; Hall *et al.*, 1984; Hughes *et al.*, 1988; Abdul *et al.*, 1989; Testa and Paczkowski, 1989; Farr *et al.*, 1990; Kemblowski and Chiang, 1990; Lenhard and Parker, 1990; Mercer and Cohen, 1990; Ballesterio *et al.*, 1994; Huntley *et al.*, 1994a). These authors note that the measured thickness of LNAPL in a monitoring well is greater than the true LNAPL thickness in the aquifer and, according Mercer and Cohen (1990), measured LNAPL thickness in wells is typically 2 to 10 times greater than the actual LNAPL thickness in the formation. The difference between actual and measured LNAPL thickness occurs because mobile LNAPL floating on the water table flows into the well (if the top of well screen is above the base of the LNAPL) and depresses the water table. Figure C.2.5 is a schematic that illustrates this relationship. The equation for correcting depth

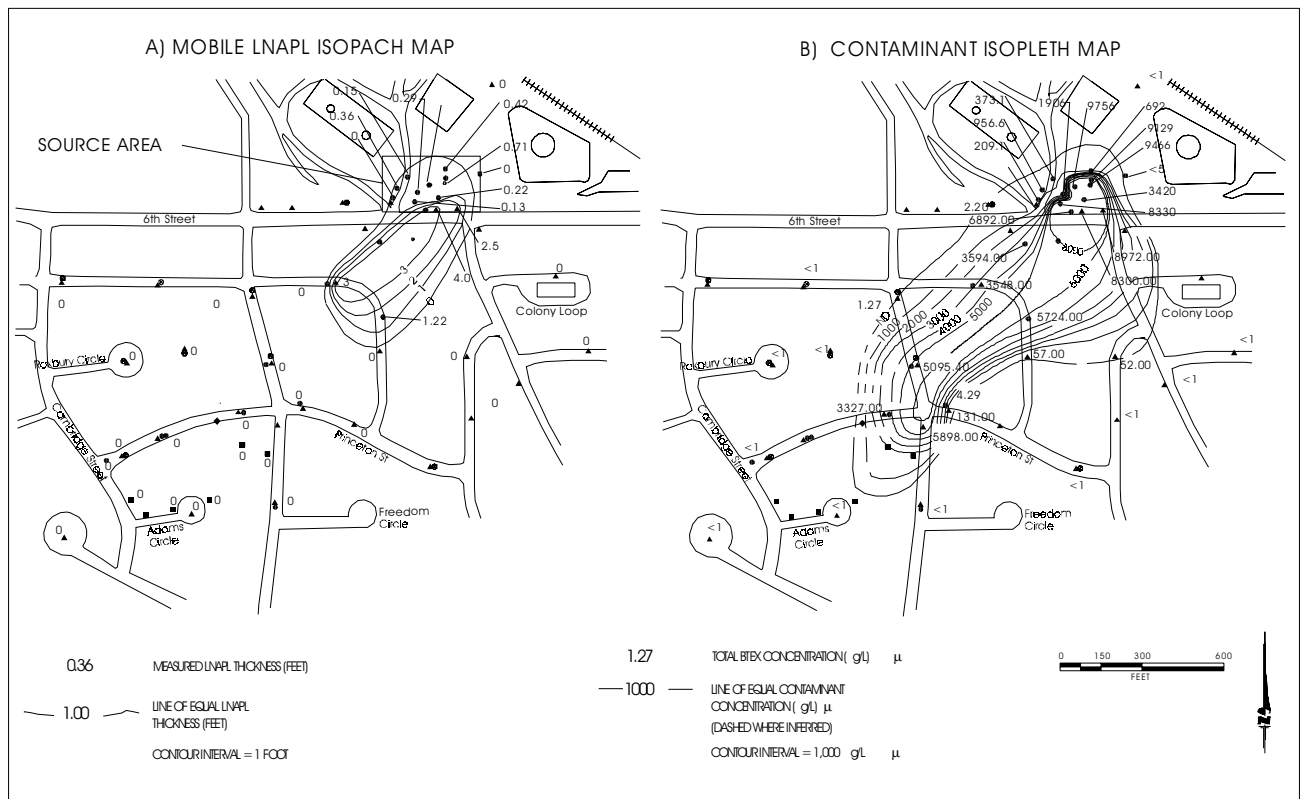

Figure C.2.4 Example mobile LNAPL isopach (A) and contaminant isopleth (B) maps.

to ground water caused by LNAPL in the well is given in Section C.2.3.2. Empirical relationships relating measured LNAPL thickness to actual LNAPL thickness are presented below. Also presented below are test methods that can be used to determine actual LNAPL thickness. There are no established methods for determining actual DNAPL volume based on measurements taken in monitoring wells.

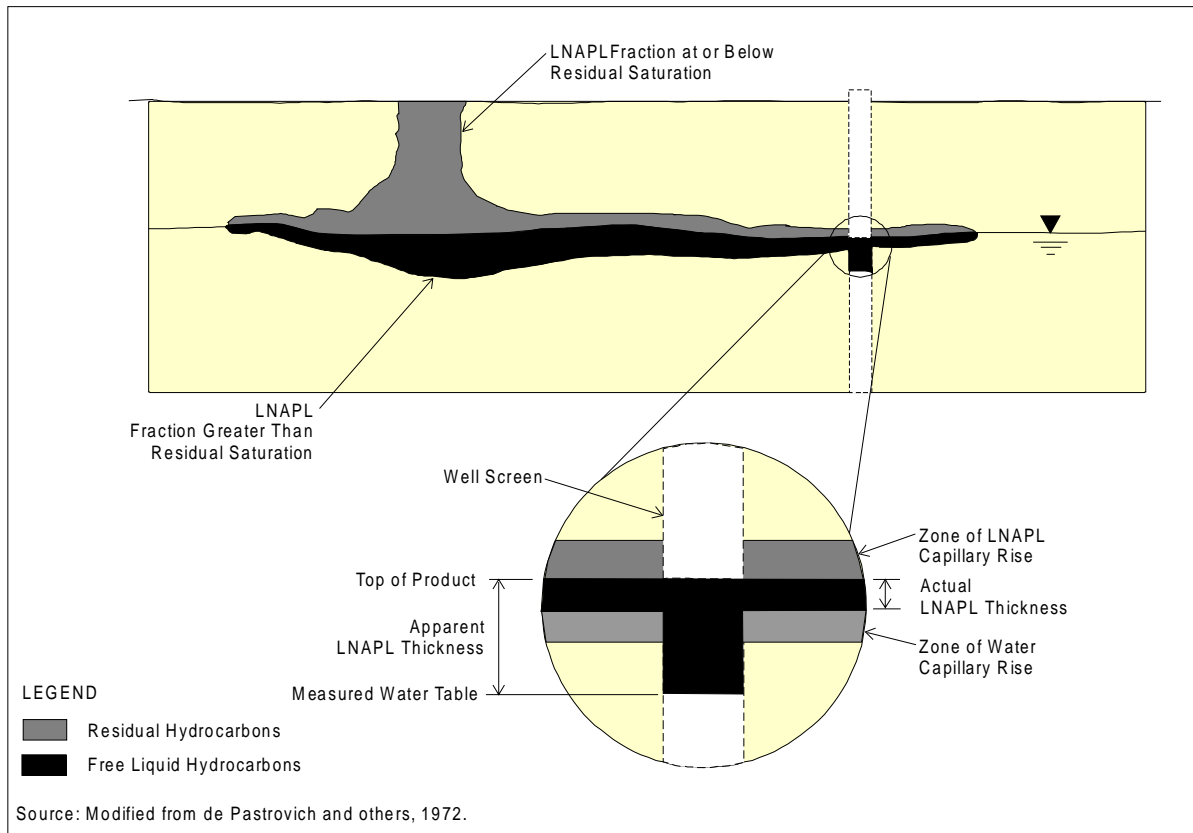

Figure C.2.5 Measured (apparent) versus actual LNAPL thickness.

C.2.3.4.2. Empirical Relationships

There are several empirical methods available to estimate the actual thickness of mobile LNAPL in the subsurface based on LNAPL thicknesses measured in a ground-water monitoring well. Such empirical relationships are, at best, approximations because many factors influence the relationship between measured and apparent LNAPL thickness (Mercer and Cohen, 1990):

- Capillary fringe height depends on grain size and is hysteretic with fluid level fluctuations.
- LNAPL can become trapped below the water table as the water table rises and falls.
- The thickness of LNAPL is ambiguous because the interval of soil containing mobile LNAPL is not 100-percent saturated with LNAPL.

Some empirical methods for determining actual LNAPL thickness are described below.

Method of de Pastrovich *et al.* (1979)

Hampton and Miller (1988) conducted laboratory experiments to examine the relationship between the actual thickness of LNAPL in a formation, h_p , and that measured in a monitoring well, h_m . Based on their research, Hampton and Miller (1988) suggest using the following relationship (developed by de Pastrovich *et al.*, 1979) to estimate LNAPL thickness:

$$h_f \approx \frac{h_m(\rho_w - \rho_{lnapl})}{\rho_{lnapl}} \quad \text{eq. C.2.3}$$

Where:

- h_f = actual thickness of LNAPL in formation
- h_m = measured LNAPL thickness in well
- ρ_w = density of water (1.0 gm/cm³ for pure water)
- ρ_{lnapl} = density of LNAPL (See Table C.3.9)

Method of Kemblowski and Chiang (1990)

Another empirical relationship was proposed by Kemblowski and Chiang (1990) to estimate actual LNAPL thickness based on measured LNAPL thickness. This relationship is given by:

$$h_o = H_o - 2.2h_{aw}^c|_{dr} \quad \text{eq. C.2.4}$$

Where:

- h_o = equivalent thickness of LNAPL in the formation (volume of oil per unit area of aquifer, divided by porosity)
- H_o = measured LNAPL thickness in well
- $h_{aw}^c|_{dr}$ = capillary height of air-water interface assuming water is being displaced by oil (typical values are given in Table C.2.1)

This method assumes equilibrium conditions, water drainage, and oil imbibition.

Table C.2.1 Typical Values for $h_{aw}^c|_{dr}$ (Bear, 1972)

Aquifer Matrix	$h_{aw}^c _{dr}$ (cm)	$h_{aw}^c _{dr}$ (ft)
Coarse Sand	2-5	0.066-0.16
Sand	12-35	0.39-1.15
Fine Sand	35-70	1.14-2.30
Silt	70-150	2.30-4.92
Clay	>200-400	>6.56-13.12

Method of Lenhard and Parker (1990)

Another empirical relationship was proposed by Lenhard and Parker (1990) to estimate actual LNAPL thickness based on measured LNAPL thickness. This relationship is given by:

$$D_o = \frac{\rho_{ro}\beta_{ao}H_o}{\beta_{ao}\rho_{ro} - \beta_{ow}(1 - \rho_{ro})} \quad \text{eq. C.2.5}$$

Where:

- D_o = actual thickness of LNAPL in formation
- H_o = measured LNAPL thickness in well
- ρ_{ro} = specific gravity of LNAPL (density of oil/density of water)
- $\beta_{ao} = \frac{\sigma_{aw}}{\sigma_{ao}}$ Air-oil scaling factor

$$\beta_{ow} = \frac{\sigma_{aw}}{\sigma_{ow}} \text{ Oil-water scaling factor}$$

σ_{aw} = surface tension of uncontaminated water (72.75 dynes/cm @ 20°C)

σ_{ao} = surface tension of LNAPL [25 dynes/cm @ 20°C for JP-4, Table C.2.2]

σ_{ow} = $\sigma_{aw} - \sigma_{ao}$ = interfacial tension between water and LNAPL (47.75 dynes/cm @ 20°C)

It is important to note that this method includes the capillary thickness of the hydrocarbon, and is, therefore, likely to be an overestimate.

Table C.2.2 Surface Tensions for Various Compounds

Compound	Surface Tension @ 20°C (dyne/cm)
JP-4	25 ^{a/}
Gasoline	19-23 ^{a/}
Pure Water	72.75 ^{b/}

a/ Martel (1987).

b/ CRC Handbook (1956).

C.2.3.4.3. LNAPL Baildown Test

The LNAPL baildown test is applicable in areas where the hydrocarbon/water interface is below the potentiometric surface, and the recharge rate of hydrocarbon into the well is slow (Hughes *et al.*, 1988).

Baildown Test Procedure (from Hughes *et al.*, 1988):

- 1) Gauge the well and calculate the corrected potentiometric surface elevation using equations C.2.1 and C.2.2.
- 2) Rapidly bail the hydrocarbon from the well.
- 3) Gauge the well again, and if the thickness of the hydrocarbon is acceptable (0.1 to 1 foot), calculate the potentiometric surface elevation. The potentiometric surface elevation thus calculated should be within 0.005 foot of the value calculated in step 1. If it is, then continue to step 4; if it is not, repeat steps 2 and 3.
- 4) Record the top of the LNAPL surface in the well as it recharges until the well is fully recharged.
- 5) Plot the elevation of the top of LNAPL in the well vs. time since bailing ceased.
- 6) The true thickness of the mobile LNAPL layer (T_f) is the distance from the inflection point to the top of the hydrocarbon under static conditions (Figure C.2.6). Thus, T_f is picked directly off the plot. Table C.2.3 is an example of the results of this procedure.

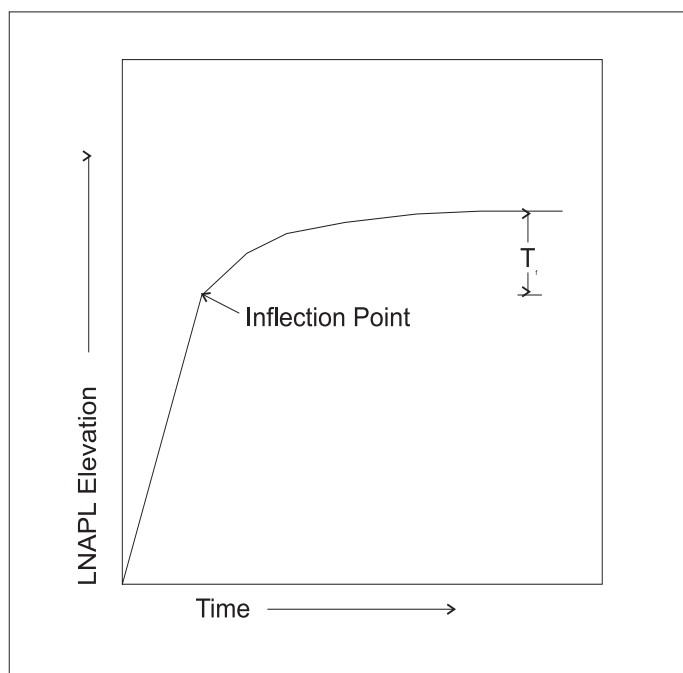

Figure C.2.6 Type curve for LNAPL baildown test.

Table C.2.3 Results of Example Baildown Test (Modified from Hughes *et al.*, 1988)

Well	T_w (ft) ^{a/}	T_f (ft)	Exaggeration (T_w/T_f)
ROW-143	4.97	0.61	8.1:1
ROW-189	12.5	0.29	43.0:1
ROW-129	0.94	0.0 ^{b/}	N/A

a/ T_w = LNAPL thickness initially measured in the well, if LNAPL thickness that is actually mobile

b/ Capillary oil only

Hughes *et al.* (1988) also present a recharge method that involves pumping the mobile LNAPL until steady-state conditions are achieved, and then letting the well fully recharge.

C.2.3.5 Preparation of Contaminant and Daughter Product Isoleth Maps

Isoleth maps should be prepared for all chlorinated solvents of concern and their daughter products and for total BTEX if present. For example, if trichloroethene and BTEX were released (as is typical for fire training areas), then maps of dissolved trichloroethene, dichloroethene, vinyl chloride, ethene, and total BTEX concentrations should be prepared. Isoleth maps allow interpretation of data on the distribution and the relative transport and degradation rates of contaminants in the subsurface. In addition, contaminant isopleth maps allow contaminant concentrations to be gridded and used for input into a solute transport model.

Isoleth maps are prepared by first plotting the concentration of the contaminant on a base map prepared using surveyor's data. Lines of equal contaminant concentration (isopleths) are then drawn

and labeled. It is important to ensure that each data point is honored during contouring. Outliers should be displayed and qualified, if they are not contoured. Figures C.2.4, C.2.7, and C.2.8 contain examples of contaminant isopleth maps.

Dissolved contaminant concentrations are determined through ground-water sampling and laboratory analysis. From these data, isopleth maps for each of the contaminant compounds and for total dissolved contaminant should be made. Dissolved BTEX concentrations are transferred to the fate and transport model grid cells by overlaying the isopleth map onto the model grid.

C.2.3.6 Preparation of Electron Donor, Inorganic Electron Acceptor, and Metabolic By-product Contour (Isopleth) Maps

Isopleth maps should be prepared for any organic compound that can be used as an electron donor. Examples of such compounds include natural organic carbon, and petroleum hydrocarbons (and landfill leachate). These maps are used to provide visible evidence that biodegradation could occur or is occurring. Isopleth maps also should be prepared for dissolved oxygen, nitrate, manganese (II), iron (II), sulfate, methane, and chloride. These maps are used to provide visible evidence that biodegradation is occurring. The electron acceptor and metabolic by-product isopleth maps can be used to determine the relative importance of each of the terminal electron-accepting processes (TEAPs).

Isopleth maps are prepared by first plotting the concentration of the electron donor, electron acceptor, or metabolic by-product on a base map prepared using surveyor's data. Lines of equal concentration (isopleths) are then drawn and labeled. It is important to ensure that each data point is honored during contouring, unless some data are suspect.

C.2.3.6.1 Inorganic Electron Acceptor Isopleth Maps

Electron acceptor isopleth maps allow interpretation of data on the distribution of dissolved oxygen, nitrate, and sulfate in the subsurface. Isopleth maps for these compounds provide a visual indication of the relationship between the contaminant plume and the electron acceptors and the

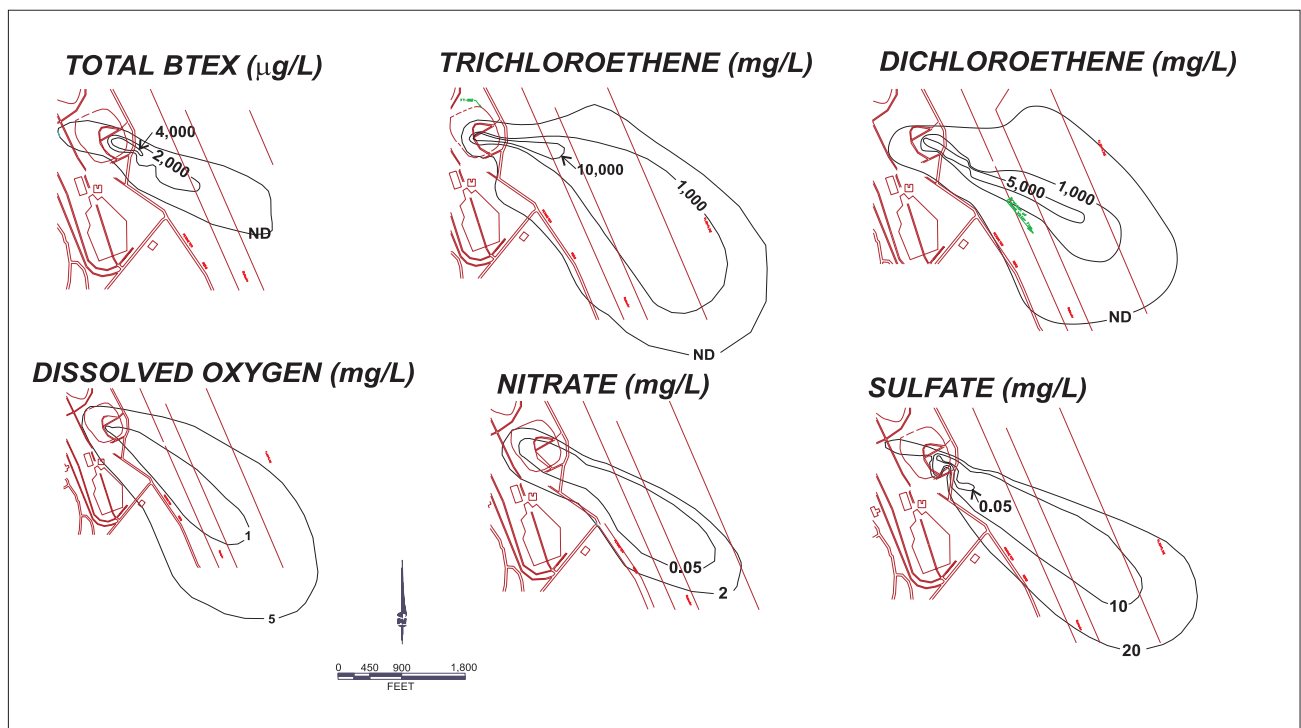

Figure C.2.7 Example isopleth maps of contaminants and soluble electron acceptors.

relative importance of each TEAP. Dissolved oxygen concentrations below background levels in areas with high organic carbon concentrations are indicative of aerobic respiration. Nitrate concentrations below background in areas with high organic carbon concentrations are indicative of denitrification. Sulfate concentrations below background in areas with high organic carbon concentrations are indicative of sulfate reduction.

Figure C.2.7 gives examples of completed isopleth maps for dissolved oxygen, nitrate, and sulfate. This figure also contains isopleth maps for TCE and DCE and the total BTEX (electron donor) isopleth map for the same period. Comparison of the total BTEX isopleth map and the electron acceptor isopleth maps shows that there is a strong correlation between areas with elevated organic carbon and depleted electron acceptor concentrations. The strong correlation indicates that the electron acceptor demand exerted during the metabolism of BTEX has resulted in the depletion of soluble inorganic electron acceptors. These relationships provide strong evidence that biodegradation is occurring via the processes of aerobic respiration, denitrification, and sulfate reduction.

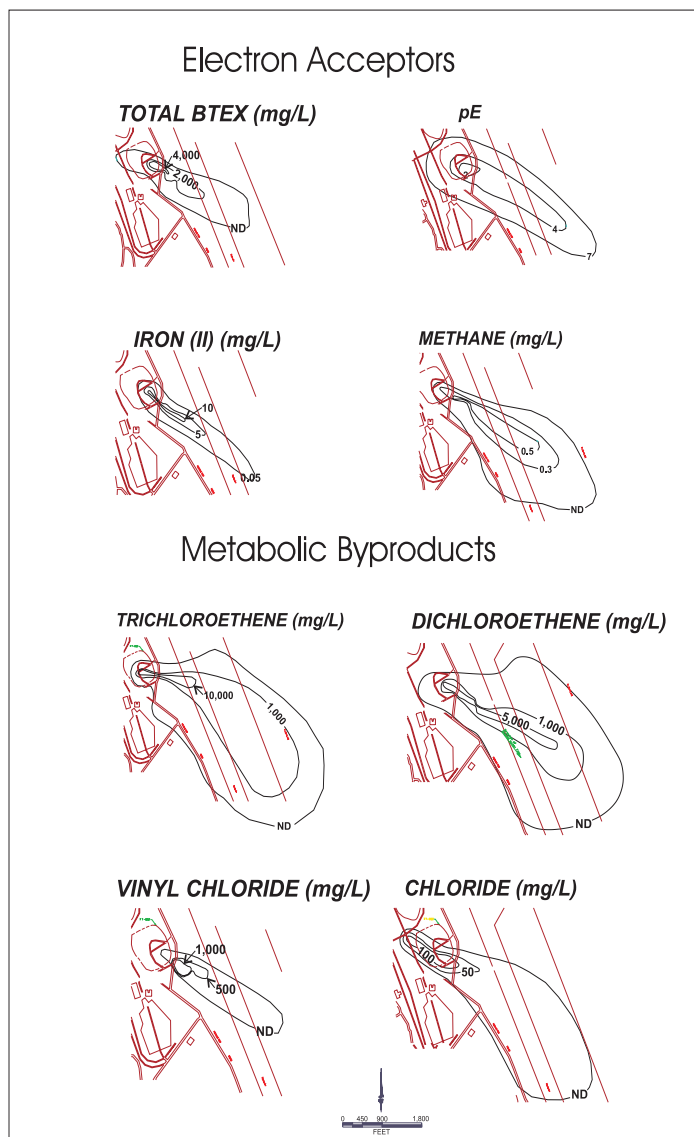

Figure C.2.8 Example isopleth maps of contaminants and metabolic by-products.

C.2.3.6.2 Metabolic By-product Isopleth Maps

Metabolic by-product maps should be prepared for manganese (II), iron (II), methane, and chloride. The manganese (II) map is prepared in lieu of an electron acceptor isopleth map for manganese (IV) because the amount of bioavailable amorphous or poorly crystalline manganese (IV) in an aquifer matrix is extremely hard to quantify. The iron (II) map is prepared in lieu of an electron acceptor isopleth map for iron (III) because the amount of bioavailable amorphous or poorly crystalline iron (III) in an aquifer matrix is extremely hard to quantify. Iron (II) concentrations above background levels in areas with BTEX contamination are indicative of anaerobic iron (III) reduction. Methane concentrations above background levels in areas with BTEX contamination are indicative of methanogenesis, another anaerobic process. Biodegradation of chlorinated solvents tends to increase the chloride concentration found in ground water. Thus, chloride concentrations inside the contaminant plume generally increase to concentrations above background. This map will allow visual interpretation of chloride data by showing the relationship between the contaminant plume and chloride. During anaerobic biodegradation, the oxidation-reduction potential of ground water is lowered. Thus, the oxidation-reduction potential (or pE) inside the contaminant plume generally decreases to levels below background.

Figure C.2.8 gives examples of completed isopleth maps for iron (II), methane, chloride, and pE. This figure also contains the TCE, DCE and Vinyl Chloride isopleth maps, and total BTEX (electron donor) isopleth map for the same period. Comparison of the total BTEX isopleth map and the metabolic by-product isopleth maps and comparison of Figures C.2.7 and C.2.8 shows that there is a strong correlation between areas with elevated organic carbon and elevated metabolic by-product concentrations. These relationships provide strong evidence that biodegradation is occurring via the processes of iron (III) reduction, methanogenesis, and reductive dechlorination.

SECTION C-3

NATURAL ATTENUATION CALCULATIONS

Several calculations using site-specific data must be made in order to document the occurrence of natural attenuation and successfully implement the natural attenuation alternative. The following sections describe these calculations.

C.3.1 CALCULATING HYDRAULIC PARAMETERS

Hydraulic parameters necessary for adequate site characterization and model implementation include hydraulic conductivity, transmissivity, hydraulic gradient, linear ground-water flow velocity, hydrodynamic dispersion, and retarded solute transport velocity. Calculations for these parameters are discussed in the following sections.

C.3.1.1 Hydraulic Conductivity

Hydraulic conductivity, K , is a measure of an aquifer's ability to transmit water and is perhaps the most important variable governing fluid flow in the subsurface. Hydraulic conductivity has the units of length over time [L/T]. Observed values of hydraulic conductivity range over 12 orders of magnitude, from 3×10^{-12} to 3 cm/sec (3×10^{-9} to 3×10^3 m/day) (Figure C.3.1 and Table C.3.1). In

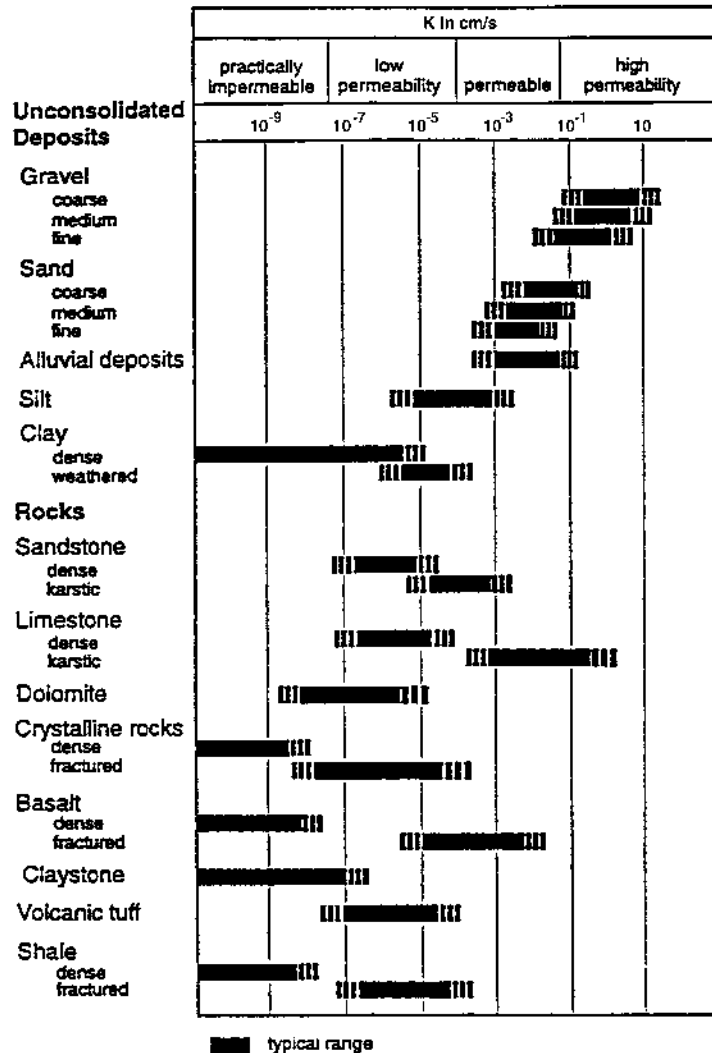

Modified from: Spitz and Moreno, 1996.

Figure C.3.1 Range of hydraulic conductivity values.

general terms, the hydraulic conductivity for unconsolidated sediments tends to increase with increasing grain size and sorting. The velocity of ground water and dissolved contaminants is directly related to the hydraulic conductivity of the saturated zone. Subsurface variations in hydraulic conductivity directly influence contaminant fate and transport by providing preferential pathways for contaminant migration. The most common methods used to quantify hydraulic conductivity in the subsurface are aquifer pumping tests and slug tests. The quantitative analysis of pumping and slug test data is beyond the scope of this document. For information on the quantitative analysis of these data, the reader is referred to the works of Kruseman and de Ridder (1991) and Dawson and Istok (1991).

Table C.3.1 *Representative Values of Hydraulic Conductivity for Various Sediments and Rocks (From Domenico and Schwartz, 1990)*

Material	Hydraulic Conductivity (m/day)	Hydraulic Conductivity (cm/sec)
UNCONSOLIDATED SEDIMENT		
Glacial till	$9 \times 10^{-8} - 2 \times 10^{-1}$	$1 \times 10^{-10} - 2 \times 10^{-4}$
Clay	$9 \times 10^{-7} - 4 \times 10^{-4}$	$1 \times 10^{-9} - 5 \times 10^{-7}$
Silt	$9 \times 10^{-5} - 2$	$1 \times 10^{-7} - 2 \times 10^{-3}$
Fine sand	$2 \times 10^{-2} - 2 \times 10^1$	$2 \times 10^{-5} - 2 \times 10^{-2}$
Medium sand	$8 \times 10^{-2} - 5 \times 10^1$	$9 \times 10^{-5} - 6 \times 10^{-2}$
Coarse sand	$8 \times 10^{-2} - 5 \times 10^2$	$9 \times 10^{-5} - 6 \times 10^{-1}$
Gravel	$3 \times 10^1 - 3 \times 10^3$	$3 \times 10^{-2} - 3$
SEDIMENTARY ROCK		
Karstic limestone	$9 \times 10^{-2} - 2 \times 10^3$	$1 \times 10^{-4} - 2$
Limestone and dolomite	$9 \times 10^{-5} - 5 \times 10^{-1}$	$1 \times 10^{-7} - 6 \times 10^{-4}$
Sandstone	$3 \times 10^{-5} - 5 \times 10^{-1}$	$3 \times 10^{-8} - 6 \times 10^{-4}$
Siltstone	$9 \times 10^{-7} - 1 \times 10^{-3}$	$1 \times 10^{-9} - 1 \times 10^{-6}$
Shale	$9 \times 10^{-9} - 2 \times 10^{-4}$	$1 \times 10^{-11} - 2 \times 10^{-7}$
CRYSTALLINE ROCK		
Vesicular basalt	$3 \times 10^{-2} - 2 \times 10^3$	$4 \times 10^{-5} - 2$
Basalt	$2 \times 10^{-6} - 3 \times 10^{-2}$	$2 \times 10^{-9} - 4 \times 10^{-5}$
Fractured igneous and metamorphic	$7 \times 10^{-4} - 3 \times 10^1$	$8 \times 10^{-7} - 3 \times 10^{-2}$
Unfractured igneous and metamorphic	$3 \times 10^{-9} - 2 \times 10^{-5}$	$3 \times 10^{-12} - 2 \times 10^{-8}$

C.3.1.1.1 Hydraulic Conductivity from Pumping Tests

Pumping tests generally provide the most reliable information about aquifer hydraulic conductivity. Pumping test data for geohydraulic characteristics are most commonly interpreted by graphic techniques. The analytical method used for interpretation of the data will depend upon the physical characteristics of the aquifer and test wells. The assumptions inherent in the analytical method used to calculate aquifer characteristics should be evaluated to ensure acceptance of the method for the subsurface conditions present at the site under investigation.

The interpretation of aquifer pumping test data is not unique. Similar sets of data can be obtained from various combinations of geologic conditions. Field data of drawdown *vs.* time and/or distance are plotted on graph paper either by hand or using programs such as AQTESOLV® or a spreadsheet program. There are numerous methods of interpreting pumping test data. The method to be used for each pumping test should be selected based on site-specific conditions (aquifer conditions, test conditions, assumptions made, etc.). Most hydrogeology text books contain pumping test evaluation techniques. Two publications dealing with pump test analysis are recommended (Kruseman and de Ridder, 1991 and Dawson and Istok, 1991).

C.3.1.1.2 Hydraulic Conductivity from Slug Tests

Slug tests are a commonly used alternative to pumping tests that are relatively easy to conduct. The biggest advantage of slug tests is that no contaminated water is produced during the test. During pumping tests at fuel-hydrocarbon-contaminated sites, large volumes of contaminated water that must be treated typically are produced. One commonly cited drawback to slug testing is that this method generally gives hydraulic conductivity information only for the area immediately surrounding the monitoring well. If slug tests are going to be relied upon to provide information on the three-dimensional distribution of hydraulic conductivity in an aquifer, multiple slug tests must be performed, both within the same well and at several monitoring wells at the site. It is not advisable to rely on data from one slug test in a single monitoring well. Data obtained during slug testing are generally analyzed using the method of Hvorslev (1951) for confined aquifers or the method of Bouwer and Rice (1976) and Bouwer (1989) for unconfined conditions.

C.3.1.2 Transmissivity

The transmissivity, T , of an aquifer is the product of the aquifer's hydraulic conductivity, K , and the saturated thickness, b :

$$T = Kb \quad \text{eq. C.3.1}$$

For a confined aquifer, b is the thickness of the aquifer between confining units. For unconfined aquifers, b is the saturated thickness of the aquifer measured from the water table to the underlying confining layer. Transmissivity has the units of length squared over time [L^2/T].

C.3.1.3 Hydraulic Head and Gradient

Determining the magnitude of hydraulic gradients is important because gradients influence the direction and rate of contaminant migration. Hydraulic head, H , and specifically, variations in hydraulic head within an aquifer, is the driving force behind ground-water movement and solute migration. The total hydraulic head at one location in a system is the sum of the elevation head, pressure head, and velocity head (Figure C.3.2):

$$H = h_z + h_p + h_v \quad \text{eq. C.3.2}$$

Where:

H = total hydraulic head [L]

h_z = elevation head = z = elevation relative to the reference plane [L]

h_p = pressure head [L]

h_v = velocity head [L]

Pressure head is given by:

$$h_p = \frac{P}{\rho g}$$

Where:

p = fluid pressure

ρ = density

g = acceleration due to gravity

Velocity head is given by:

$$h_v = \frac{v^2}{2g}$$

Where:

v = ground-water velocity

g = acceleration due to gravity

Because h_v is generally assumed to be zero for most ground-water flow, the relationship for total head is generally written:

$$H = z + \frac{P}{\rho g} \quad \text{eq. C.3.3}$$

Thus, the total hydraulic head at a point measured by a piezometer is the sum of the elevation at the base of the piezometer plus the length of the water column in the piezometer. The total hydraulic head in a piezometer is determined by measuring the depth from a surveyed reference point (datum) to the surface of the standing water. The elevation of the water surface is the total hydraulic head in the piezometer. This total head is the total head at the base of the piezometer, not the water table elevation, unless the piezometer terminates immediately below the water table or is a well screened

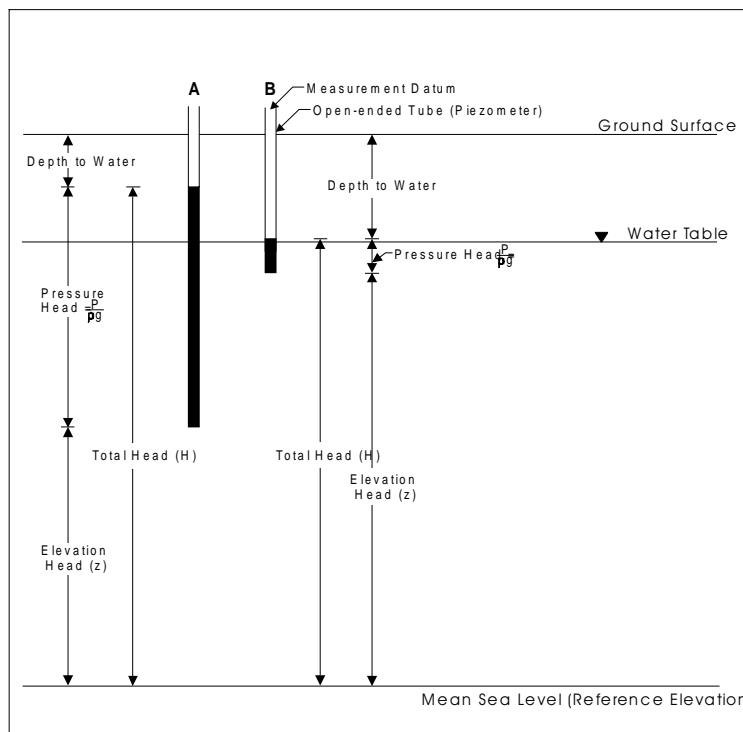

Figure C.3.2 Hydraulic head.

across the water table. Figure C.3.2 shows a pair of nested piezometers that illustrate the relationships between total hydraulic head, pressure head, and elevation head. Because ground water flows from areas with high total head (point A, Figure C.3.2) to areas with lower total head (point B), this figure depicts a water table aquifer with a strong upward vertical gradient. This figure illustrates how nested piezometers (or wells) are used to determine the importance of vertical gradients at a site. This figure also illustrates the importance of using wells screened in the same portion of the aquifer (preferably across the water table) when preparing potentiometric surface maps.

The hydraulic gradient (dH/dL) is a dimensionless number that is the change in hydraulic head (dH) between two points divided by the length of ground-water flow between these same two points, parallel to the direction of ground-water flow, and is given by:

$$\text{Hydraulic Gradient} = \frac{dH}{dL} \quad \text{eq. C.3.4}$$

Where:

dH = change in total hydraulic head between two points [L]

dL = distance between the two points used for head measurement [L]

In a system where flow is not occurring, the total hydraulic head, H , is the same everywhere in the system and the hydraulic gradient is zero. To accurately determine the hydraulic gradient, it is necessary to measure ground-water levels in all monitoring wells at the site. Because hydraulic gradients can change over a short distance within an aquifer, it is essential to have as much site-specific ground-water elevation information as possible so that accurate hydraulic gradient calculations can be made. In addition, seasonal variations in ground-water flow direction can have a profound influence on contaminant transport. To determine the effect of seasonal variations in ground-water flow direction on contaminant transport, quarterly ground-water level measurements should be taken over a period of at least 1 year.

The hydraulic gradient must be determined parallel to the direction of ground-water flow. Unless two monitoring wells screened in the same relative location within the same hydrogeologic unit are located along a line parallel to the direction of ground-water flow, the potentiometric surface map is generally used to determine the hydraulic gradient. To determine the hydraulic gradient, an engineer's scale is used to draw a line perpendicular to the equal-potential lines on the potentiometric surface map (i.e., parallel to the direction of ground-water flow). Measure the distance between the two equal-potential lines, making note of the ground-water potential at each equal-potential line. Subtract the larger potential from the smaller potential, and divide this number by the distance between the two equal potential lines, being sure to use consistent units. The number generated will be a negative number because water flows from areas of higher potential to areas of lower potential.

Example C.3.1: Hydraulic Gradient Calculation

Given the water table elevation map shown in Figure C.3.3, calculate the hydraulic gradient between points A and B. Assume that all wells are screened across the water table.

Solution:

The hydraulic gradient is given by dH/dL . The line connecting points A and B is parallel to the direction of ground-water flow. The water table elevation is 4659.34 ft msl at point A and 4602.41 ft msl at point B. Therefore, because ground water flows from areas of high head to areas of lower head:

$$dH = 4602.41 - 4659.34 = -56.93 \text{ feet}$$

The distance between the two points A and B is 936 feet. Therefore:

$$dL = 936 \text{ feet}$$

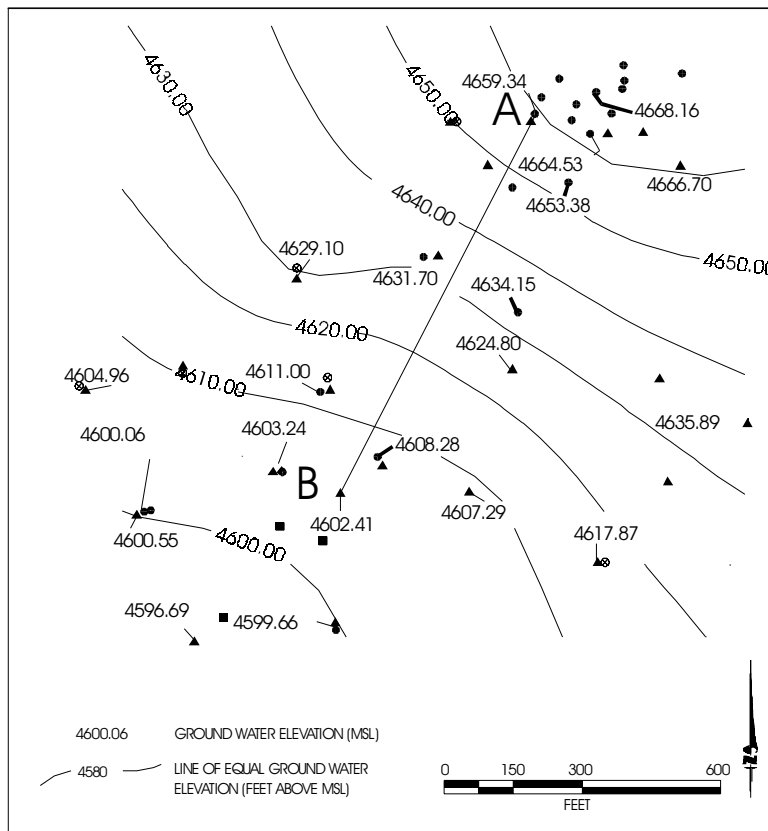

Figure C.3.3 Ground water elevation map.

and

$$\frac{dH}{dL} = \frac{-56.93 \text{ ft}}{936 \text{ ft}} = -9.06 \frac{\text{ft}}{\text{ft}} = -0.06 \frac{\text{m}}{\text{m}}$$

C.3.1.4 Total Porosity (n) and Effective Porosity (n_e)

Total porosity (n) is the volume of voids in a unit volume of aquifer. Specific retention is the amount of water (volumetric) that is retained against the force of gravity after a unit volume of an unconfined aquifer is drained. Storativity is defined as the volume of water that a confined aquifer takes into or releases from storage per unit surface area of the aquifer per unit change in total hydraulic head. Effective porosity, n_e , is the total porosity of the aquifer minus the specific retention (unconfined) or storativity (confined) of the aquifer:

$$n_e = n - S \quad \text{eq. C.3.5}$$

Where:

n_e = effective porosity [dimensionless]

n = total porosity [dimensionless]

S = specific retention (unconfined) or storativity (confined) [dimensionless]

Effective porosity can be estimated using the results of a tracer test. Although this is potentially the most accurate method, time and monetary constraints can be prohibitive. For this reason, the most common technique is to use an accepted literature value for the types of materials making up the aquifer matrix, and then to calibrate a contaminant transport model by adjusting the value of effective porosity (in conjunction with other input parameters such as transmissivity) within the range of

accepted literature values until the modeled and observed contaminant distribution patterns match. Because aquifer materials can have a range of effective porosity, sensitivity analyses should be performed to determine the effect of varying the effective porosity on numerical model results. Values of effective porosity chosen for the sensitivity analyses should vary over the accepted range for the aquifer matrix material. Table C.3.2 presents accepted literature values for total porosity and effective porosity.

Table C.3.2 *Representative Values of Dry Bulk Density, Total Porosity, and Effective Porosity for Common Aquifer Matrix Materials (After Walton, 1988 and Domenico and Schwartz, 1990)*

Aquifer Matrix	Dry Bulk Density (gm/cm³)	Total Porosity	Effective Porosity
Clay	1.00-2.40	0.34-0.60	0.01-0.2
Peat	---	---	0.3-0.5
Glacial Sediments	1.15-2.10	---	0.05-0.2
Sandy Clay	---	---	0.03-0.2
Silt	---	0.34-0.61	0.01-0.3
Loess	0.75-1.60	---	0.15-0.35
Fine Sand	1.37-1.81	0.26-0.53	0.1-0.3
Medium Sand	1.37-1.81	---	0.15-0.3
Coarse Sand	1.37-1.81	0.31-0.46	0.2-0.35
Gravelly Sand	1.37-1.81	---	0.2-0.35
Fine Gravel	1.36-2.19	0.25-0.38	0.2-0.35
Medium Gravel	1.36-2.19	---	0.15-0.25
Coarse Gravel	1.36-2.19	0.24-0.36	0.1-0.25
Sandstone	1.60-2.68	0.05-0.30	0.1-0.4
Siltstone	---	0.21-0.41	0.01-0.35
Shale	1.54-3.17	0.0-0.10	---
Limestone	1.74-2.79	0.0-50	0.01-0.24
Granite	2.24-2.46	---	---
Basalt	2.00-2.70	0.03-0.35	---
Volcanic Tuff	---	---	0.02-0.35

C.3.1.5 Linear Ground-water Flow Velocity (Seepage or Advective Velocity)

The average linear ground-water flow velocity (seepage velocity) in one dimension in the direction parallel to ground-water flow in a saturated porous medium is given by:

$$v_x = \frac{K}{n_e} \frac{dH}{dL} \quad \text{eq. C.3.6}$$

Where:

v_x = average linear ground-water velocity parallel to ground-water flow direction (seepage velocity) [L/T]

K = hydraulic conductivity [L/T]

n_e = effective porosity [L³/L³]

$\frac{dH}{dL}$ = hydraulic gradient [L/L]

The average linear ground-water flow velocity should be calculated to estimate ground-water flow and solute transport velocity, to check the accuracy of ground-water models, and to calculate first-order biodegradation rate constants.

Example C.3.2: Linear Ground-water Flow Velocity Calculation

Calculate the linear ground-water flow velocity in a medium-grained sandy aquifer. The hydraulic gradient as determined from the potentiometric surface map in the previous example is -0.06 m/m. The hydraulic conductivity is 1.7×10^{-1} m/day as determined by pumping tests.

Solution:

Because the effective porosity of this sediment is not known, it is necessary to estimate this parameter. From Table C.3.2, the effective porosity for a medium-grained sand is approximately 23 percent.

$$v_x = -\frac{K}{n_e} \frac{dH}{dL} = -\frac{(0.17 \text{ m/day})(-0.06 \text{ m/m})}{0.23} = 0.044 \text{ m/day}$$

C.3.1.6 Coefficient of Retardation and Retarded Contaminant Transport Velocity

When the average linear velocity of a dissolved contaminant is less than the average linear velocity of the ground water, the contaminant is said to be “retarded.” The difference between the velocity of the ground water and that of the contaminant is caused by sorption and is described by the coefficient of retardation, R , which is defined as:

$$R = \frac{v_x}{v_c} \quad \text{eq. C.3.7}$$

Where:

R = coefficient of retardation

v_x = average linear ground-water velocity parallel to ground-water flow

v_c = average velocity of contaminant parallel to groundwater flow

The ratio v_x/v_c describes the relative velocity between the ground water and the dissolved contaminant. When $K_d = 0$ (no sorption), the transport velocities of the ground water and the solute are equal ($v_x = v_c$). If it can be assumed that sorption is adequately described by the distribution coefficient, the coefficient of retardation for a dissolved contaminant (for saturated flow) is given by:

$$R = 1 + \frac{\rho_b K_d}{n} \quad \text{eq. C.3.8}$$

Where:

R = coefficient of retardation

ρ_b = bulk density (Section C.3.1.6.1)

K_d = distribution coefficient (Section C.3.1.6.2)

n = total porosity

This relationship expresses the coefficient of retardation in terms of the bulk density and effective porosity of the aquifer matrix and the distribution coefficient for the contaminant. Substitution of this equation into equation C.3.7 gives:

$$\frac{v_x}{v_c} = 1 + \frac{\rho_b K_d}{n} \quad \text{eq. C.3.9}$$

Solving for the contaminant velocity, v_c , gives:

$$v_c = \frac{v_x}{1 + \frac{\rho_b K_d}{n}} \quad \text{eq. C.3.10}$$

Retardation of a contaminant relative to the advective transport velocity of the ground-water flow system has important implications for natural attenuation. If retardation is occurring, dissolved oxygen and other electron acceptors traveling at the advective transport velocity of the ground water sweep over the contaminant plume from the upgradient margin. This results in greater availability of electron acceptors within the plume for biodegradation of fuel hydrocarbons. In addition, adsorption of a contaminant to the aquifer matrix results in dilution of the dissolved contaminant plume.

C.3.1.6.1 Bulk Density

The bulk density of a soil, ρ_b , as used in most ground-water models, expresses the ratio of the mass of dried soil to its total volume (solids and pores together).

$$\rho_b = \frac{M_s}{V_T} = \frac{M_s}{(V_s + V_a + V_w)} \quad \text{eq. C.3.11}$$

Where:

- ρ_b = bulk density
- M_s = mass of solid in the system
- V_T = total volume in the system
- V_s = volume of solid in the system
- V_a = volume of air (or gas) in the system
- V_w = volume of water (or liquid) in the system

Bulk density is related to particle density by:

$$\rho_b = (1 - n)\rho_s \quad \text{eq. C.3.12}$$

Where:

- ρ_b = bulk density
- n = total porosity
- ρ_s = density of grains comprising the aquifer

The bulk density is always less than the particle density, ρ_s ; for example, if pores constitute half the volume, then ρ_b is half of ρ_s . The bulk density of a soil is affected by the structure of the soil (looseness and degree of compaction), as well as by its swelling and shrinking characteristics, both of which depend on clay content and soil moisture. Even in extremely compacted soil, the bulk density remains appreciably lower than the particle density. This is because the particles can never interlock perfectly, and the soil remains a porous body, never completely impervious. In sandy soils, ρ_b can be as high as 1.81 gm/cm³. In aggregated loams and clayey soils, ρ_b can be as low as 1.1gm/cm³. Table C.3.2 contains representative values of dry bulk density for common sediments and rocks.

C.3.1.6.2 Distribution Coefficient and Total Organic Carbon Content

The distribution coefficient is described in Section B.4.3. Recall equation B.4.10, which gives the relationship between f_{oc} and K_{oc} :

$$K_d = K_{oc} f_{oc} \quad \text{eq. C.3.13}$$

Where:

K_d = distribution coefficient [L^3/M]

K_{oc} = soil adsorption coefficient for soil organic carbon content [L^3/M]

f_{oc} = fraction soil organic carbon (mg organic carbon/mg soil) [M/M]

Representative K_{oc} values are given in Table B.4.1. The fraction of soil organic carbon must be determined from site-specific data. Representative values of total organic carbon (TOC) in common sediments are given in Table C.3.3. Because most solute transport occurs in the most transmissive aquifer zones, it is imperative that soil samples collected for total organic carbon analyses come from these zones in background areas. To be conservative, the average of all total organic carbon concentrations from sediments in the most transmissive aquifer zone should be used for retardation calculations.

Table C.3.3 Representative Values of Total Organic Carbon for Common Sediments

Texture	Depositional Environment	Fraction Organic Carbon	Site Name
medium sand	fluvial-deltaic	0.00053 - 0.0012	Hill AFB, Utah
fine sand		0.0006 - 0.0015	Bolling AFB, D.C.
fine to coarse sand	back-barrier (marine)	0.00026 - 0.007	Patrick AFB, Florida
organic silt and peat	glacial (lacustrine)	0.10 - 0.25	Elmendorf AFB, Alaska
silty sand	glaciofluvial	0.0007 - 0.008	Elmendorf AFB, Alaska
silt with sand, gravel and clay (glacial till)	glacial moraine	0.0017 - 0.0019	Elmendorf AFB, Alaska
medium sand to gravel	glaciofluvial	0.00125	Elmendorf AFB, Alaska
loess (silt)	eolian	0.00058 - 0.0016	Offutt AFB, Nebraska
fine - medium sand	glaciofluvial or glaciolacustrine	< 0.0006 - 0.0061	Truax Field, Madison Wisconsin
fine to medium sand	glaciofluvial	0.00021 - 0.019	King Salmon AFB, Fire Training Area, Alaska
			Dover AFB, Delaware
fine to coarse sand	glaciofluvial	0.00029 - 0.073	Battle Creek ANGB, Michigan
sand	fluvial	0.0057	Oconee River, Georgia ^{a/}
coarse silt	fluvial	0.029	Oconee River, Georgia ^{a/}
medium silt	fluvial	0.020	Oconee River, Georgia ^{a/}
fine silt	fluvial	0.0226	Oconee River, Georgia ^{a/}
silt	lacustrine	0.0011	Wildwood, Ontario ^{b/}
fine sand	glaciofluvial	0.00023 - 0.0012	Various sites in Ontario ^{b/}
medium sand to gravel	glaciofluvial	0.00017 - 0.00065	Various sites in Ontario ^{b/}

a/ Karickhoff, 1981

b/ Domenico and Schwartz (1990)

Example C.3.3: Retarded Solute Transport Velocity Calculation

For ground-water flow and solute transport occurring in a shallow, saturated, well-sorted, fine-grained, sandy aquifer, with a total organic carbon content of 0.7 percent, a hydraulic gradient of - 0.015 m/m, and an hydraulic conductivity of 25 m/day, calculate the retarded contaminant velocity for trichloroethene.

Solution:

Because the total porosity, effective porosity, and the bulk density are not given, values of these parameters are obtained from Table C.3.2. The median values for total porosity, effective

porosity, and bulk density are approximately 0.4, 0.2, and 1.6 kg/L, respectively.

The first step is to calculate the average linear ground-water velocity, v_x .

$$v_x = -\frac{(25 \text{ m/day})(-0.015 \text{ m/m})}{0.2} = 1.9 \text{ m/day}$$

The next step is to determine the distribution coefficient, K_d . Values of K_{oc} for chlorinated solvents and BTEX are obtained from Tables B.2.1 and B.2.2, respectively, and are listed in Table C.3.4.

For trichloroethene $K_{oc} = 87 \text{ L/kg}$, and (using equation C.3.13):

$$K_d = \left(87 \frac{\text{L}}{\text{kg}}\right)(0.007) = 0.61 \frac{\text{L}}{\text{kg}}$$

The retarded contaminant velocity is given by (equation C.3.10):

$$v_c = \frac{1.9 \text{ m/day}}{1 + \frac{(1.6 \text{ kg/L})(0.61 \text{ L/kg})}{0.4}} = 0.55 \text{ m/day}$$

Table C.3.4 presents the estimated coefficient of retardation contaminant velocity for a number of contaminants under the conditions of Example C.3.3. This example illustrates that contaminant sorption to total organic carbon can have a profound influence on contaminant transport by significantly slowing the rate of dissolved contaminant migration.

Table C.3.4 Example Retardation Calculations for Select Compounds

Compound	K_{oc} L/kg	Fraction Organic Carbon	Distribution Coefficient (L/kg)	Bulk Density (kg/L)	Total Porosity	Coefficient of Retardation	Advective Ground-water Velocity (m/day)	Contaminant Velocity (m/day)
Benzene	79	0.007	0.553	1.60	0.40	3.21	1.90	0.59
Toluene	190	0.007	1.33	1.60	0.40	6.32	1.90	0.30
Ethylbenzene	468	0.007	3.276	1.60	0.40	14.10	1.90	0.13
m-xylene	405	0.007	2.835	1.60	0.40	12.34	1.90	0.15
Tetrachloroethene	209	0.007	1.463	1.60	0.40	6.85	1.90	0.28
Trichloroethene	87	0.007	0.609	1.60	0.40	3.44	1.90	0.55
cis-1,2-Dichloroethene	49	0.007	0.343	1.60	0.40	2.37	1.90	0.80
Vinyl Chloride	2.5	0.007	0.0175	1.60	0.40	1.07	1.90	1.78
1,3,5-trimethylbenzene	676	0.007	4.732	1.60	0.40	19.93	1.90	0.10

C.3.2 CONTAMINANT SOURCE TERM CALCULATIONS

NAPLs present in the subsurface represent a continuing source of ground-water contamination. NAPLs may be made up of one compound, or more likely, a mixture of compounds. Concentrations of dissolved contaminants and the lifetime of NAPL source areas and associated ground-water plumes are ultimately determined by the rate at which contaminants dissolve from the NAPL. When sufficient quantities of NAPL are present, the unsaturated zone may initially be saturated with

NAPL, and the NAPL may migrate under the influence of gravity. After a period of time the NAPL may drain from the pores under the influence of gravity, leaving a thin coating of NAPL. Depending on the surface area of the subsurface materials, the surface tension of the NAPL, and the porosity and permeability of the subsurface materials, some NAPL also may be held between the grains by capillarity. NAPL adhering to the grains of the aquifer matrix or retained by capillarity is herein referred to as residual NAPL. In residual zones, NAPL will be present in immobile blobs or ganglia that may occupy 10 percent or less of the pore space (Feenstra and Guiguer, 1996). If the NAPL is at saturation and is mobile within and among the pores of the aquifer matrix, the NAPL is referred to as mobile NAPL. Mobile NAPL may occupy as much as 50 to 70 percent of the pore space and can reduce flow of water through these zones.

In the unsaturated zone, dissolution from residual or mobile NAPL into downward-migrating precipitation (recharge) will occur, as well as migration and dissolution of vapors. In the saturated zone, dissolution of contaminants from residual NAPL occurs as ground-water flows through the residual zone. Dissolution from mobile NAPL mostly takes place along the tops, bottoms, or lateral margins of the NAPL bodies, because ground-water (or recharge) flow through the NAPL is restricted. Because the distribution of residual NAPL results in a greater surface area of product in contact with ground water and does not restrict ground-water velocities, concentrations of contaminants entering ground water will typically be closer to the compounds' equilibrium solubilities than in the case of mobile NAPL bodies. The equilibrium solubility of the compound(s) of interest will depend on the composition of the NAPL (i.e., the molar fraction of the NAPL represented by the compound).

In general, residual and mobile NAPL may be present above or below the water table, but direct dissolution into ground water will only occur when NAPL is at or below the capillary fringe. In either case, quantifying the flux of contamination entering ground water from above or below the water table is a difficult proposition. The processes governing dissolution from NAPLs are complex and depend upon many variables (Feenstra and Guiguer, 1996). Among these variables (in the saturated zone) are the shape of a mobile NAPL body, the contact area between the NAPL and the ground water, the velocity of the ground water moving through or past the NAPL, the effect of residual NAPL on the effective porosity of the contact zone, the solubility of the compounds of interest, the relative fractions of the compounds in the NAPL, the diffusion coefficients of the compounds, and the effects of other compounds present in the NAPL. This will be further complicated by any processes in the vadose zone (e.g., volatilization, dissolution from residual NAPL into recharge, or dissolution of vapors into recharge) that also will add contaminant mass to ground water. Further, as the mass of the NAPL body changes over time, the rate of dissolution will also change. Clearly, given the number of variables that affect the transfer of contaminant mass to ground water, it is difficult to accurately estimate the flux of contaminants into ground water. Depending on the intended use of the flux estimate, different approaches can be used.

If one desires to estimate a source term for a contaminant fate and transport model, one can attempt to estimate the mass loading rate and use that estimate as an input parameter. However, this often does not yield model concentrations (dissolved) that are similar to observed concentrations. As a result, the source in the model often becomes a calibration parameter (Mercer and Cohen, 1990; Spitz and Moreno, 1996). This is because the effects of the source (i.e., the dissolved contaminant plume) are easier to quantify than the actual flux from the source. The frequent need for such a "black box" source term has been borne out during modeling associated with evaluations of natural attenuation of fuel hydrocarbons [following the AFCEE technical protocol (Wiedemeier *et al.*, 1995d)] at over 30 U.S. Air Force sites. Use of other methods to calculate source loading for those models often produced model concentrations that differed from observed concentrations by as

much as an order of magnitude. From the model, the flux estimate then can be used for estimating source lifetimes or other such calculations.

For other purposes, one can estimate flux using several methods, as summarized by Feenstra and Guiguer (1996). For bodies of mobile LNAPL, this is more practical, because the area of NAPL in contact with ground water can be estimated from plume/pool dimensions. Where most NAPL is residual, the surface area can be highly variable, and cannot be measured in the field. Laboratory studies to understand and quantify mass transfer from residual NAPL in porous media are in the early stages, and when such mass transfer is modeled, surface area is a calibration parameter with great uncertainty (Abriola, 1996). Most methods of estimating NAPL dissolution rates require an estimate of the contact area and, therefore, will contain a great deal of uncertainty. This is one of the main reasons why, for purposes of modeling, the “black box” source term is more commonly used.

One reason practitioners want to estimate mass transfer rates is to provide a basis for estimating contaminant source lifetimes, which can affect regulatory decisions and remedial designs. To determine how long it will take for a dissolved contaminant plume to fully attenuate, it is necessary to estimate how fast the contaminants are being removed from the NAPL. In general, it is difficult to estimate cleanup times, so conservative estimates should be made based on NAPL dissolution rates. Predicting the cleanup time for sites with mobile NAPL is especially difficult because residual NAPL will remain after the recoverable mobile NAPL has been removed. Of course, this is all complicated by the many factors that affect dissolution rates as discussed above. Moreover, most methods do not account for changing dissolution rates as a result of NAPL volume loss (and subsequent surface area decrease), preferential partitioning from mixed NAPLs, and the change in porosity (and, therefore, ground-water velocity) resulting from NAPL dissolution. Finally, the mass of the NAPL present in the subsurface must also be estimated, lending further uncertainty to any calculation of source lifetime.

There are several ways to quantify the mass loading rate from a body of mobile or residual NAPL. Feenstra and Guiguer (1996) present a good summary of some common methods. As noted above, transfer rates calculated from these methods are all dependent upon several parameters, many of which cannot be measured or derived from the literature. This is especially true for residual NAPL. Johnson and Pankow (1992) present a method for estimating dissolution rates from pools of NAPL which contact ground water over an area that is essentially two-dimensional. Many other dissolution models may be available; however, as noted before, the experimental evidence to support dissolution models is really just starting to be collected. Despite these limitations, some of these models can prove useful, and a selected few are presented (in limited detail) in the following subsections.

If estimating mass flux rates is less important, one can use direct measurement or equilibrium concentration calculations to estimate contaminant source area concentrations. The first method involves directly measuring the concentration of dissolved contaminants in ground water near the NAPL plume. The second method involves the use of partitioning calculations. These approaches are described in the following sections. This type of data can be useful if it can be demonstrated that the source is not capable of introducing concentrations of compounds of concern that exceed regulatory limits, or that with slight weathering the same results can be expected. Source area concentrations, whether measured or calculated, also may be used to provide calibration targets for transport models in which a “black box” source term is used.

If contaminant concentrations in the residual and mobile NAPL are not decreasing over time, or if they are decreasing very slowly, extremely long times will be required for natural attenuation of the dissolved contaminant plume. This will likely make natural attenuation less feasible and will reduce the chance of implementation. In order for natural attenuation to be a viable remedial option, the

source of continuing ground-water contamination must be decreasing over time (decaying), either by natural weathering processes or via engineered remedial solutions such as mobile NAPL recovery, soil vapor extraction, bioventing, or bioslurping. Because natural weathering processes can be fairly slow, especially in systems where the NAPL dissolves slowly or is inhibited from volatilizing or biodegrading, it will generally be necessary to implement engineered remedial solutions to remove the NAPL or reduce the total mass of residual and dissolved NAPL.

A discussion of estimating source terms for sites contaminated solely with fuel hydrocarbons is presented by Wiedemeier *et al.* (1995a). In general, estimating dissolution rates of individual compounds from fuels is simpler than estimating rates of dissolution from other NAPL mixtures because there is a great deal of experimental evidence regarding partitioning and equilibrium solubilities of individual compounds from common fuel mixtures. Methods presented in the following subsections can use such data to reduce some of the uncertainty in source term calculations.

Typical uses of chlorinated solvents (e.g., degreasing or parts cleaning) and past disposal practices that generally mixed different waste solvents or placed many types of waste solvents in close proximity have resulted in complex and greatly varying NAPL mixtures being released at sites. For mixtures containing other compounds (e.g., either DNAPLs containing multiple chlorinated compounds, or fuel LNAPLs containing commingled chlorinated compounds), the equilibrium solubility of the individual compounds of interest must first be calculated, then that information can be used in the common mass transfer rate calculations. Except in the case of pure solvent spills, therefore, the estimation of dissolution rates is then further complicated by this need to estimate equilibrium solubilities from the mixture.

Because this work focuses largely on saturated-zone processes, vadose zone dissolution processes will not be discussed in any detail. However, this discussion will provide a starting point for estimating source terms for ground-water contaminant fate and transport modeling, as well as for estimating source and plume lifetimes. As a starting point, two basic methods of estimating or measuring equilibrium dissolved contaminant concentrations in the vicinity of NAPL bodies are presented. In addition, methods for estimating fluxes summarized by Feenstra and Guiguer (1996) and presented by Johnson and Pankow (1992) will be briefly summarized.

C.3.2.1 Direct Measurement of Dissolved Contaminant Concentrations in Ground Water in Contact with NAPL

Two methods can be used to determine the dissolved concentration of contaminants in ground water near a NAPL plume. The first method involves collecting ground-water samples from near a NAPL lens in monitoring wells. The second method involves collecting samples of mixed NAPL and water from monitoring wells.

C.3.2.1.1 Collecting Ground-water Samples from Near the NAPL

This method involves carefully sampling ground water beneath a floating LNAPL lens or near a DNAPL lens. One way of collecting a ground-water sample from beneath a lens of floating LNAPL or above/adjacent to a DNAPL body involves using a peristaltic pump. For LNAPL, the depth to the base of the mobile LNAPL is measured, a length of high-density polyethylene (HDPE) tubing that will reach 1 to 2 feet beneath the LNAPL is lowered into the well, and the sample is collected. For DNAPL, the tube would be cut to reach 1 to 2 feet above the NAPL. Another useful technique for obtaining such samples where the depth to ground water is too deep to allow use of a peristaltic pump is to use a Grundfos® pump. If a Grundfos® pump is used to collect a water sample from beneath LNAPL, it is imperative that the pump be thoroughly cleaned after each use, and that good sampling logic be used (e.g., sample less contaminated wells first). Also, dedicated bladder pumps that are being used for long-term monitoring (LTM) in wells with NAPL can be used to collect water samples from beneath or above the NAPL.

C.3.2.1.2 Collecting Mixed Ground-water/NAPL Samples

This method involves collecting a sample of ground water and NAPL from a monitoring well, placing the sample in a sealed container used for volatile organics analysis being careful to ensure there is no headspace, allowing the sample to reach equilibrium, and submitting the water above or below the floating NAPL to a qualified laboratory for analysis. A disposable bailer generally works best for collection of this type of sample. Smith *et al.* (1981) has information on how to conduct such a test for LNAPL. Two or three samples should be collected from different monitoring wells containing NAPL at the site. This test should only be done when it is not possible to collect a discrete sample from above or below the NAPL.

C.3.2.2 Equilibrium Partitioning Calculations

The NAPL present at a site represents a continuing source of contamination because chlorinated solvents, BTEX, and other compounds will partition from the NAPL into the ground water. In such cases, it is generally necessary to estimate the dissolved concentration of contaminants expected in ground water near the LNAPL. Partitioning calculations can be performed for sites with NAPL to quantify contaminant loading from the NAPL into the ground water at the time the ground water or NAPL samples are collected. Such calculations allow a crude estimation of the impact of continuing sources of contamination on dissolved contaminant concentrations. The results of partitioning calculations may show that even if the NAPL is allowed to remain in the ground, dissolved contaminant concentrations will remain below regulatory guidelines. This is especially true when weathered NAPLs with initially low contaminant concentrations are present. Partitioning calculations made by Wiedemeier *et al.* (1993) showed that NAPL present in the subsurface at a fueling facility near Denver, Colorado, was incapable of producing dissolved contaminant concentrations in ground water above regulatory standards. Such partitioning calculations should be confirmed with an LTM program.

On the other hand, if partitioning calculations indicate that continued dissolution will produce contaminant concentrations exceeding regulatory guidelines, further work will be needed. The contaminant concentrations calculated by equilibrium methods will clearly not provide mass flux estimates that can be used in modeling; again, the “black box” methods will be more useful. Moreover, there is no estimation of the actual mass flux across the entire body of NAPL and, therefore, source lifetimes and weathering rates cannot be estimated directly from partitioning data. More advanced calculations, such as those that will be discussed in later sections, are then required, keeping in mind that greater uncertainties will be introduced.

When found in the saturated zone, residual NAPL is extremely difficult to remove. Maximum contaminant concentrations resulting from such partitioning will occur when the ground water and NAPL reach equilibrium. Assuming that equilibrium is reached gives the most conservative modeling results.

C.3.2.2.1 Equilibrium Partitioning of Contaminants from Mobile NAPL into Ground Water

Because most NAPLs will be a mixture of compounds, the solubilities of those compounds will be lower than the solubility of the individual compound (which is what is most commonly found in the literature). For an organic NAPL mixture, the dissolved concentration of each compound (in equilibrium with the mixture) can be approximated by:

$$C_{sat,m} = X_m C_{sat,p} \quad \text{eq. C.3.14}$$

Where:

$C_{sat,m}$ = solubility of compound from mixture

X_m = mole fraction of compound in the mixture

$C_{sat,p}$ = solubility of pure compound

This equilibrium concentration may also be referred to as the effective solubility of the compound from the mixture. Experimental evidence (Banerjee, 1984; Broholm and Feenstra, 1995) have suggested that eq. C.3.14 produces reasonable approximations of effective solubilities for mixtures of structurally similar compounds, and that the relationship works best for binary mixtures of similar compounds. For other mixtures, the error is greater due to the complex solubility relationships created; however, the method is appropriate for many environmental studies for which there are many other uncertainties (Feenstra and Guiguer, 1996).

For complex mixtures (e.g., multiple identified and unidentified solvents, or mixed fuels and solvents), it will be necessary to estimate the weight percent and an average molecular weight of the unidentified fraction of the NAPL before the calculation can be completed. In doing so, it should be remembered that increasing the average molecular weight for the unidentified fraction will produce greater estimated effective solubilities for the identified contaminants. A higher molecular weight for the unidentified fraction will result in a lower mole fraction for that fraction and, therefore, higher mole fractions (and solubilities) for the known compounds. Feenstra and Guiguer (1996) provide an example of these calculations for a mixture of chlorinated and nonchlorinated compounds.

In the case of fuel hydrocarbon mixtures, experimental partitioning data has been collected and used to develop individual-compound solubility calculations, largely because fuel mixtures are somewhat consistent in their makeup. The fuel-water partitioning coefficient, K_{fw} , is defined as the ratio of the concentration of a compound in the fuel to the compound's equilibrium concentration in water in contact with the fuel:

$$K_{fw} = \frac{C_f}{C_w} \quad \text{eq. C.3.15}$$

Where:

K_{fw} = fuel-water partitioning coefficient [dimensionless]

C_f = concentration of the compound in the fuel [M/L³]

C_w = concentration of the compound dissolved in ground water [M/L³]

A summary of values of K_{fw} for BTEX and trimethylbenzenes (TMB) in jet fuel and gasoline are presented by Wiedemeier *et al.* (1995d), along with the relationships relating K_{fw} to the aqueous solubility of a pure compound in pure water, S , which can be used to estimate K_{fw} for compounds for which there is no experimental data.

Using the definition of K_{fw} presented above, the maximum (equilibrium) total dissolved BTEX concentration resulting from the partitioning of BTEX from NAPL into ground water is given by:

$$C_w = \frac{C_f}{K_{fw}} \quad \text{eq. C.3.16}$$

This relationship predicts the concentration of dissolved BTEX in the ground water if the LNAPL is allowed to remain in contact with the ground water long enough so that equilibrium between the two phases is reached. Further discussion and example calculations for this method are presented by Wiedemeier *et al.* (1995d).

C.3.2.3 Mass Flux Calculations

In general, the rate of mass transfer from a NAPL can be given as the product of a mass transfer coefficient, a concentration difference, and a contact area. As Feenstra and Guiguer (1996) note, the driving force for mass transfer is the concentration difference across a boundary layer between the NAPL and the ground water. The concentration difference can be approximated using the effective solubility of a compound (eq. C.3.14) and either the measured concentration of the compound in ground water adjacent to the NAPL, or a calculated (theoretical) ground-water concentration. How-

ever, the contact area and the mass transfer coefficient incorporate a great deal of uncertainty and are typically calibration parameters for modeling dissolution, as discussed previously.

Once these parameters have been estimated, one can use them in a variety of models. In general, models for dissolution of NAPL in porous media either assume local equilibrium between phases, or assume that dissolution is a first-order process governed by the variables discussed above (Feenstra and Guiguer, 1996). Abriola and Pinder (1985a), Baehr and Corapcioglu (1987), and Kaluarachchi and Parker (1990) developed two-dimensional NAPL migration models that account for dissolution using the local equilibrium assumption (LEA). As noted by Abriola (1996), these studies generally were computer modeling studies for which follow-up laboratory work is ongoing and uncovering additional factors to consider. For single-component NAPLs, models utilizing a first-order reaction have been developed by Miller *et al.* (1990), Powers *et al.* (1992), Brusseau (1992), Guiguer (1993), and Guiguer and Frind (1994). For multi-component NAPLs, a model developed by Shiu *et al.* (1988) and Mackay *et al.* (1991) may be of use.

Due to approximate nature of flux calculations and the inherent uncertainty in those calculations, we have chosen to omit a detailed discussion of such efforts. The numerical modeling using LEA methods is beyond the scope of this work, and may not be practical for use at most sites. Instead, we will present a brief review of ideas presented by Feenstra and Guiguer (1996) and Johnson and Pankow (1992) in order to illustrate some of the concepts involved in estimating flux terms. Should further detail or other methods be desired, both of those works provide excellent background and references to start with, including many of the works referenced in this discussion of source term calculations.

C.3.2.3.1 General Mass Transfer Models

Using concepts from the field of chemical engineering, Feenstra and Guiguer (1996) note that for a single-component NAPL, simple dissolution of the compound may be described by:

$$N = K_c (C_w - C_{sat}) \quad \text{eq. C.3.17}$$

Where:

- N = flux of the species of interest (M/L²T)
- K_c = mass transfer coefficient (L/T)
- C_w = concentration of compound in bulk aqueous phase (M/L³)
- C_{sat} = concentration of compound at NAPL-water interface (taken as the solubility of the compound) (M/L³)

The mass transfer coefficient may be calculated various ways, but in all cases, the diffusivity of the species of interest is a factor. Feenstra and Guiguer (1996) present three methods for determining a mass transfer coefficient.

In a porous media, the mass transfer rate per volume of porous medium can be defined by multiplying the mass flux by the ratio of NAPL surface contact area to the unit volume of porous medium, yielding:

$$N^* = \lambda (C_w - C_{sat}) \quad \text{eq. C.3.18}$$

Where:

- N^* = flux of the species of interest per unit volume of porous medium (M/L²T)
- λ = lumped mass transfer coefficient (L/T)
- C_w = concentration of compound in bulk aqueous phase (M/L³)
- C_{sat} = concentration of compound at NAPL-water interface (taken as the solubility of the compound) (M/L³)

The lumped mass transfer coefficient is the product of K_c and the ratio of the NAPL surface contact

area and the unit volume of the porous media. This can further be extended for multicomponent NAPLs :

$$N_m^* = \lambda_m (C_{w,m} - C_{sat,m}) \quad \text{eq. C.3.19}$$

Where:

N_m^* = flux of component m per unit volume of porous medium (M/L²T)

λ_m = lumped mass transfer coefficient for component m (L/T)

$C_{w,m}$ = concentration of component m in bulk aqueous phase (M/L³)

$C_{sat,m}$ = concentration of component m at NAPL-water interface (calculated using eq. C.3.14) (M/L³)

Further complicating all of these relationships is the fact that as dissolution continues, λ_m will vary over time as the amount of NAPL changes. This can be accounted by using the following first-order relation:

$$N_m = S_w \lambda_m (C_{sat,m} - C_{w,m}) \quad \text{eq. C.3.20}$$

Where:

N_m = flux of component m per unit volume of porous medium (M/L²T)

S_w = average fraction of pore volume occupied by water

λ_m = lumped mass transfer coefficient for component m (L/T)

$C_{w,m}$ = concentration of component m in bulk aqueous phase (M/L³)

$C_{sat,m}$ = concentration of component m at NAPL-water interface (calculated using eq. C.3.14) (M/L³)

Again, it bears repeating that on the field scale, measurement of many of the parameters used for these calculations is not possible, and, therefore, great uncertainty is introduced. Source terms calculated using these or any other methods should be presented in that light, and if used for solute transport modeling, should be accompanied with a sensitivity analysis.

C.3.2.3.2 Nonequilibrium Partitioning Model of Johnson and Pankow (1992)

The steady-state, two-dimensional dissolution of contaminants from a pool of NAPL floating on the water table into ground water (assumed to be a semi-infinite medium) can be described by the steady-state, two-dimensional, advection-dispersion equation (Hunt *et al.*, 1988):

$$v_x \frac{\partial C}{\partial x} = D_z \frac{\partial^2 C}{\partial z^2} \quad x, z > 0 \quad \text{eq. C.3.21}$$

Where:

C = contaminant concentration dissolved in water

v_x = average linear ground-water velocity

D_z = vertical dispersion coefficient

If it is assumed that:

- The time required for total NAPL dissolution is exceedingly long in comparison to the contact time between the NAPL pool and the flowing ground water
- The NAPL pool is wide compared to the horizontal transverse mixing process
- The NAPL pool can be approximated as a rectangle
- The NAPL lens width does not affect the dissolution rate
- The elevation of the NAPL lens is taken as $z=0$, with z measured positively upward
- The boundary conditions are:

$$\begin{aligned}
C(x, z = 0) &= 0 \\
C(x, z = 0) &= C_e \quad 0 \leq x \leq L \\
C(x = 0, z) &= 0
\end{aligned}$$

Where:

- C = contaminant concentration dissolved in water
- C_e = effective water solubility
- L = horizontal length of NAPL pool

then the rate of dissolution of constituents from an LNAPL lens into ground water flowing beneath the lens can be calculated as two-dimensional, steady-state dissolution, and the surface area averaged mass transfer rate, M_a, is calculated as (Johnson and Pankow, 1992; Hunt *et al.*, 1988):

$$M_a = C_e n_e \sqrt{\frac{4 D_z v_x}{\pi L}} \quad \text{eq. C.3.22}$$

Where:

- n_e = effective porosity
- L = length of NAPL lens parallel to ground-water flow direction
- v_x = average linear ground-water flow velocity
- C_e = effective water solubility (proportional to a compound's pure phase solubility and mole fraction in the NAPL)
- D_z = vertical dispersion coefficient

The vertical dispersion coefficient, D_z, results from a combination of molecular diffusion and mechanical dispersion and is defined as (Johnson and Pankow, 1992):

$$D_z = D_e + v_x \alpha_z \quad \text{eq. C.3.23}$$

Where:

- D_e = effective molecular diffusivity (corrected for porosity and tortuosity)
- α_z = vertical dispersivity (typically 0.01 of longitudinal dispersivity)
- v_x = average linear ground-water flow velocity

A typical value of D_e for a nonpolar organic compound is 1 x 10⁻⁵ cm²/sec (Sellers and Schreiber, 1992).

“At very low flow velocities where molecular diffusion dominates, the average concentration decreases with increasing flow velocity because of decreasing contact time. At higher groundwater flow velocities where dispersion dominates over diffusion, average percent solubility becomes independent of velocity. This is because the transverse dispersion coefficient is proportional to flow velocity, and D_z/v is constant. At typical groundwater flow velocities, an effluent concentration far less than the solubility limit is expected. For example, for a flow velocity of 1 m/day and α_z=10⁻⁴ m, less than 1 percent of solubility is predicted, and considerable pumping would be required to remove the contaminant. The analysis predicts a constant contaminant concentration dissolved in the extracted water as long as the separate phase covers the boundary” (Hunt *et al.*, 1988, pp. 1253 and 1254).

C.3.3 CONFIRMING AND QUANTIFYING BIODEGRADATION

Chemical evidence of two types can be used to document the occurrence of biodegradation. The first type of evidence is graphical and is provided by the electron acceptor and metabolic byproduct maps discussed in Section C.2. The second line of evidence involves using a conservative tracer.

C.3.3.1 Isopleth Maps

The extent and distribution of contamination relative to electron acceptors and metabolic byproducts can be used to qualitatively document the occurrence of biodegradation. Depleted dissolved oxygen concentrations in areas with fuel hydrocarbon contamination indicates that an active zone of aerobic hydrocarbon biodegradation is present. Depleted nitrate and sulfate concentrations in areas with fuel hydrocarbon contamination indicate that an active zone of anaerobic hydrocarbon biodegradation is present and that denitrification and sulfate reduction are occurring. Elevated iron (II) and methane concentrations in areas with fuel hydrocarbon contamination indicate that an active zone of anaerobic hydrocarbon biodegradation is present and that iron reduction and methanogenesis are occurring. Isopleth maps of contaminants, electron acceptors, and metabolic byproducts can be used as evidence that biodegradation of fuel hydrocarbons is occurring. Figures C.2.7 and C.2.8 show how these maps can be used to support the occurrence of biodegradation. Figure C.2.7 shows that areas with depleted dissolved oxygen, nitrate, and sulfate correspond with areas having elevated BTEX concentrations. Figure C.2.8 shows that areas with elevated iron (II) and elevated methane concentrations also coincide with areas having elevated BTEX concentrations. These figures suggest that aerobic respiration, denitrification, iron reduction, sulfate reduction, and methanogenesis are all occurring at the example site.

C.3.3.2 Data Set Normalization

In order to calculate biodegradation rates accurately, measured contaminant concentrations must be normalized for the effects of dispersion, dilution, and sorption. A convenient way to do this is to use compounds or elements associated with the contaminant plume that are relatively unaffected or predictably affected by biologic processes occurring within the aquifer. At sites where commingled fuel hydrocarbon and chlorinated solvent plumes are present, the trimethylbenzene isomers (TMB), which can be biologically recalcitrant under some geochemical conditions have proven useful when estimating biodegradation rates for BTEX and chlorinated solvents. At sites where TMB data are not available, the chloride produced as a result of biodegradation or the carbon nucleus of the chlorinated compound can be used as a tracer.

Measured concentrations of tracer and contaminant from a minimum of two points along a flow path can be used to estimate the amount of contaminant that would be expected to remain at each point if biodegradation were the only attenuation process operating to reduce contaminant concentrations. The fraction of contaminant remaining as a result of all attenuation processes can be computed from the measured contaminant concentrations at two adjacent points. The fraction of contaminant that would be expected to remain if dilution and dispersion were the only mechanisms for attenuation can be estimated from the tracer concentrations at the same two points. The tracer is affected by dilution and dispersion to the same degree as the contaminant of interest and is not affected by biologic processes. The following equation uses these assumptions to solve for the expected downgradient contaminant concentration if biodegradation had been the only attenuation process operating between two points along the flow path:

$$C_{B,corr} = C_B \left(\frac{T_A}{T_B} \right) \quad \text{eq. C.3.24}$$

Where:

- $C_{B,corr}$ = corrected contaminant concentration at a point B downgradient
- C_B = measured contaminant concentration at point B
- T_A = tracer concentration at a point A upgradient
- T_B = tracer concentration at point B downgradient

This equation can be used to estimate the theoretical contaminant concentration that would result from biodegradation alone for every point along a flow path on the basis of the measured contaminant concentration at the origin and the dilution of the tracer along the flow path. This series of normalized concentrations can then be used to estimate a first-order rate of biodegradation as described in Section C.3.3.3.

C.3.3.2.1 Normalization Using Organic Compounds as Tracers

A convenient way of estimating biodegradation rate constants is to use compounds present in the dissolved contaminant plume that are biologically recalcitrant. One such compound that is useful in some, but not all, ground-water environments is Trimethylbenzene (TMB). The three isomers of this compound (*1,2,3*-TMB, *1,2,4*-TMB, and *1,3,5*-TMB) are generally present in sufficient quantities in fuel mixtures to be readily detectable when dissolved in ground water. When chlorinated solvents enter the subsurface as a mixture with petroleum hydrocarbons, the TMB compounds can be useful tracers. The TMB isomers are fairly recalcitrant to biodegradation under anaerobic conditions; however, the TMB isomers do not make good tracers under aerobic conditions (because they are readily biodegraded in aerobic environments). The degree of recalcitrance of TMB is site-specific, and the use of this compound as a tracer must be evaluated on a case-by-case basis. Nevertheless, if any TMB mass is lost to biodegradation, equation C.3.24 will be conservative because the calculated mass losses and the attenuation rate constants calculated on the basis of those losses will be lower than the actual losses and attenuation rates. Another compound of potential use as a conservative tracer is tetramethylbenzene; however, detectable dissolved tetramethylbenzene concentrations are generally less common than detectable dissolved TMB concentrations.

An ideal tracer would have Henry's Law and soil sorption coefficients identical to the contaminant of interest; however, TMB is more hydrophobic than BTEX, chlorinated ethenes, and chlorinated ethanes, resulting in a higher soil sorption coefficient than the compound of interest. As a result, use of TMB as a tracer is often conservative, and the biodegradation rates can be underestimated. It is best, whenever possible, to compare several tracers to determine whether they are internally consistent.

C.3.3.2.2 Normalization Using Inorganics as Tracers

Inorganic compounds also can serve as tracers for the contaminant of interest as long as their presence is in some way associated (either directly or indirectly) with the dissolved contaminant plume. For many chlorinated solvent plumes, the sum of ionic chloride and organic chloride associated with the solvents can be considered a conservative tracer. Note that the following discussion assumes that the background chloride concentration is negligible in comparison to the source area concentration of total chloride plus chlorine. If background chloride is more than approximately 10 percent of the total source area chloride plus chlorine concentration, then background concentrations will need to be accounted for prior to performing the tracer normalization.

Total chlorine can easily be calculated by multiplying the measured concentration of a chlorinated organic compound by the mass fraction of chlorine in the molecule, then summing that quantity for all the chlorinated organic compounds represented in the plume. The stoichiometry for chlorinated ethenes is presented in the following paragraphs.

As PCE is reduced to ethene, 4 moles of chloride are produced:



On a mass basis, the ratio of chloride produced to PCE degraded is given by:

Molecular weights:	PCE	$2(12.011) + 4(35.453) = 165.83 \text{ gm}$
	Chloride	$4(35.453) = 141.81 \text{ gm}$
Mass Ratio of Chloride to PCE = $141.81:165.83 = 0.86:1$		

Similarly, as TCE is reduced to ethene, 3 moles of chloride are produced:

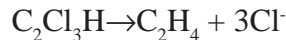

On a mass basis, the ratio of chloride produced to TCE degraded is given by:

Molecular weights:	TCE	$2(12.011) + 3(35.453) + 1(1.01) = 131.39 \text{ gm}$
	Chloride	$3(35.453) = 106.36 \text{ gm}$
Mass Ratio of Chloride to TCE = $106.36:131.39 = 0.81:1$		

Likewise, as DCE is reduced to ethene, 2 moles of chloride are produced:

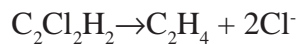

On a mass basis, the ratio of chloride produced to DCE degraded is given by:

Molecular weights:	DCE	$2(12.011) + 2(35.453) + 2(1.01) = 96.95 \text{ gm}$
	Chloride	$2(35.453) = 70.9 \text{ gm}$
Mass Ratio of Chloride to DCE = $70.9:96.95 = 0.73:1$		

As VC is reduced to ethene, 1 mole of chloride is produced:

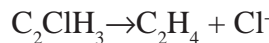

On a mass basis, the ratio of chloride produced to VC degraded is given by:

Molecular weights:	VC	$2(12.011) + 1(35.453) + 3(1.01) = 62.51 \text{ gm}$
	Chloride	$1(35.453) = 35.453 \text{ gm}$
Mass Ratio of Chloride to VC = $35.453:62.51 = 0.57:1$		

Therefore, the amount of total chloride plus chlorine for a spill undergoing reductive dechlorination would be estimated as:

$$[\text{Cl}_{\text{Total}}] = 0.86[\text{PCE}] + 0.81[\text{TCE}] + 0.73[\text{DCE}] + 0.57[\text{VC}] \quad \text{eq. C.3.25}$$

Example C.3.4: Calculating Total Concentration of Chloride and Organic Chlorine

The approach is illustrated in the following data set from the West TCE Plume at the St. Joseph, Michigan NPL site.

A series of discrete vertical water samples were taken in transects that extended across the plume at locations downgradient of the source of TCE. The locations of the samples are depicted in Figure C.3.5 as circles. At each sampling location, water samples were acquired using a hollow-stem auger. The leading auger was slotted over a five-foot interval. After a sample was collected, the auger was driven five feet further into the aquifer and the next sample was collected. At any one location, the water samples were collected in a sequential and continuous series that extended from the water table to a clay layer at the bottom of the aquifer. The concentrations of contaminants at each location were averaged in water samples that extend across the entire vertical extent of the plume. The location with the highest average concentration of chlorinated ethenes in a particular transect was selected to represent the centerline of the plume. The locations of the sample locations in the centerline of the plume are depicted in Figure C.3.5 as open circles. Each centerline location is labelled in an oval.

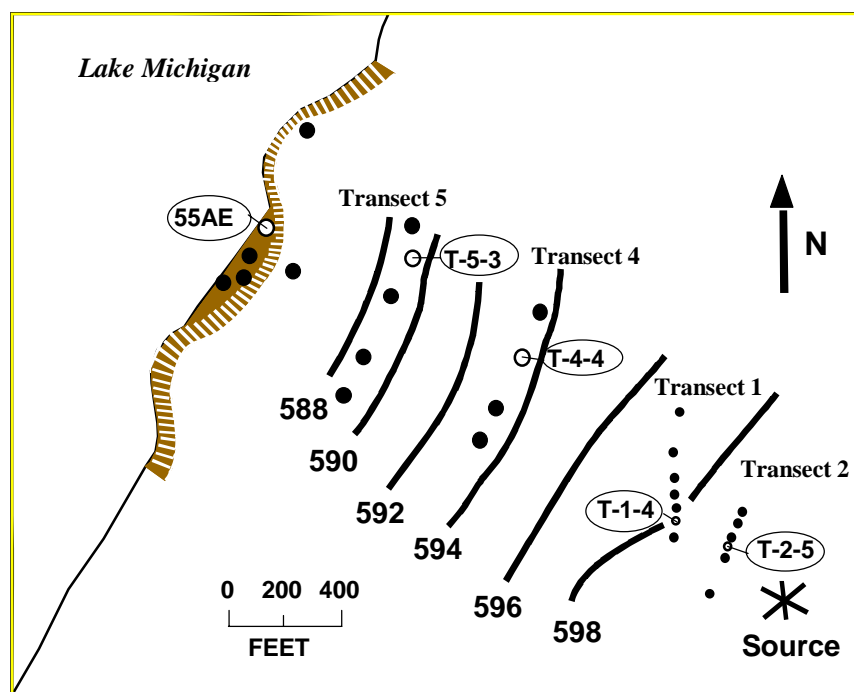

Figure C.3.4 Location of sampling points at the St. Joseph, Michigan, NPL site.

The concentrations of chlorinated ethenes and chloride in the centerline of the TCE plume at St. Joseph, Michigan, are presented in Table C.3.5.

Table C.3.5 Attenuation of Chlorinated Ethenes and Chloride Downgradient of the Source of TCE in the West Plume at the St. Joseph, Michigan, NPL Site.

Compound	Sampling Locations				
	T-2-5	T-1-4	T-4-2	T-5-3	55AE
	Distance Downgradient (feet)				
	0	200	1,000	1,500	2,000
	------(mg/Liter)-----				
PCE	0.0	0.0	0.0	0.0	0.0
TCE	12.1	3.4	1.3	0.035	0.022
Total DCE	37.6	11.7	2.4	0.23	0.45
Vinyl Chloride	2.3	3.7	0.51	0.063	0.070
Total Organic Chloride	38.5	13.4	3.2	0.2	0.4
Chloride	89.7	78.6	98.9	63.6	54.7
Tracer (Total Chloride plus Chlorine)	128.2	92.0	102.1	63.8	55.1

At the monitoring point closest to the source of the plume (see location T-2-5 in Table C.3.5 and Figure C.3.4) the concentrations of TCE, total DCE, vinyl chloride and chloride were 12.1, 37.6, 2.3 and 89.7 mg/L, respectively. This results in an upgradient tracer concentration of

TCE chlorine	+	(0.809)(12.1 mg/L)
DCE chlorine	+	(0.731)(37.6 mg/L)
Vinyl chloride chlorine	+	(0.567)(2.3 mg/L)
Chloride	+	89.7 mg/L
Total chloride plus chlorine	=	128.2 mg/L

At the downgradient location 55AE, which is 2,000 feet from the source, the concentrations of TCE, total DCE, vinyl chloride, and chloride were 0.022, 0.45, 0.070, and 54.70 mg/L, respectively. This results in a downgradient concentration of

TCE chlorine	+	(0.809)(0.022 mg/L)
DCE chlorine	+	(0.731)(0.45 mg/L)
Vinyl chloride chlorine	+	(0.567)(0.070 mg/L)
Chloride	+	54.7 mg/L
Total chloride plus chlorine	=	55.1 mg/L

The computed series of total chloride plus chlorine concentrations can be used with equation C.3.24 to estimate a normalized data set for contaminant concentrations.

Example C.3.5: Normalizing Contaminant Concentrations Along a Flow Path

Equation 3.24 will be used to calculate a normalized concentration for TCE at the locations depicted in Figure C.3.4 and Table C.3.5. Given are the observed concentrations of TCE and tracer (Table C.3.5) for five points that form a line parallel to the direction of ground-water flow (Figure C.3.4) To calculate normalized concentrations of TCE using the attenuation of the tracer, the dilution of the tracer is calculated at each location by dividing the concentration of tracer at the source (or most contaminated location) by the concentration of tracer at each downgradient location. Then the measured concentration of TCE downgradient is multiplied by the dilution of the tracer. The corrected concentrations of TCE are presented in Table C.3.6. This information will be used in sections C.3.3.3 to calculate the rate of natural biodegradation of TCE.

Table C.3.6. Use of the Attenuation of a Tracer to Correct the Concentration of TCE Downgradient of the Source of TCE in the West Plume at the St. Joseph, Michigan, NPL Site

Compound	Sampling Locations				
	T-2-5	T-1-4	T-4-2	T-5-3	55AE
	Distance Down Gradient (feet)				
	0	200	1,000	1,500	2,000
	------(mg/Liter)-----				
TCE	12.1	3.4	1.3	0.035	0.022
Tracer	128.2	92.0	102.1	63.8	55.1
Dilution of Tracer	128.2/ 28.2	128.2/ 92.0	128.2/ 102.1	128.2/ 63.8	128.2/ 55.1
Corrected TCE	12.1	4.7	1.6	0.070	0.051

C.3.3.3 Calculating Biodegradation Rates

Several methods, including first- and second-order approximations, may be used to estimate the rate of biodegradation of chlorinated compounds when they are being used to oxidize other organic compounds. Use of the first-order approximation can be appropriate to estimate biodegradation rates

for chlorinated compounds when the rate of biodegradation is controlled solely by the concentration of the contaminant. However, the use of a first-order approximation may not be appropriate when more than one substrate is limiting microbial degradation rates or when microbial mass is increasing or decreasing. In such cases, a second- or higher-order approximation may provide a better estimate of biodegradation rates.

C.3.3.3.1 First-Order Decay

As with a large number of processes, the change in a solute's concentration in ground water over time often can be described using a first-order rate constant. A first-order approximation, if appropriate, has the advantage of being easy to calculate and simplifies fate and transport modeling of complex phenomenon. In one dimension, first-order decay is described by the following ordinary differential equation:

$$\frac{dC}{dt} = -kt \quad \text{eq. C.3.26}$$

Where:

C = concentration at time t [M/L³]

k = overall attenuation rate (first-order rate constant) [1/T]

Solving this differential equation yields:

$$C = C_o e^{-kt} \quad \text{eq. C.3.27}$$

The overall attenuation rate groups all processes acting to reduce contaminant concentrations and includes advection, dispersion, dilution from recharge, sorption, and biodegradation. To determine the portion of the overall attenuation that can be attributed to biodegradation, these effects must be accounted for, and subtracted from the total attenuation rate.

Aronson and Howard (1997) have compiled a large number of attenuation rate constants for biodegradation of organic compounds in aquifers. This information is supplied to provide a basis for comparison of rate constants determined for at a particular site to the general experience with natural attenuation as documented in the literature. It is not intended to provide rate constants for a site in a risk assessment or exposure assessment. The rate constants used to describe behavior of a particular site must be extracted from site characterization information particular to that site.

The distribution of the rate constants reported for TCE is presented in Figure C.3.5. Notice that the average rate is near 1.0 per year, and that most of the rates cluster in a relatively narrow range between 3.0 per year and 0.3 per year. Some of the published rates are very low, less than 0.1 per year. The report compiles data from sites where rates are published. The general bias against publishing negative data suggests that there are many plumes where TCE attenuation was not detectable (Type 3 behavior), and that data on these plumes is not found in the literature. The data from Aronson and Howard (1997) reflect the behavior of plumes where reductive dechlorination is an important mechanism (Type 1 and Type 2 sites). Rate constants for PCE and Vinyl Chloride are presented in Figures C.3.6 and C.3.7. The average rate for dechlorination of PCE is somewhat faster than for TCE, near 4.0 per year, and the rate for Vinyl Chloride is slower, near 0.6 per year.

Two methods for determining first-order biodegradation rates at the field scale are presented. The first method involves the use of a normalized data set to compute a decay rate. The second method was derived by Buscheck and Alcantar (1995) and is valid for steady-state plumes. Wiedemeier *et al.* (1996b) compare the use of these two methods with respect to BTEX biodegradation.

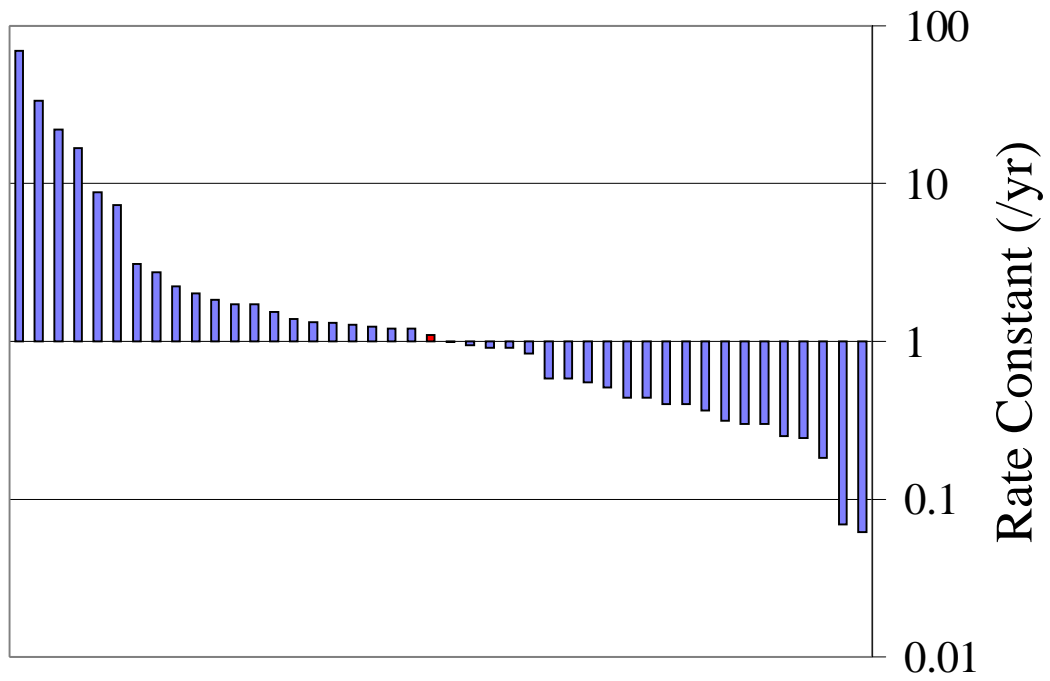

Figure C.3.5. Field rate constants for TCE as reported in literature.

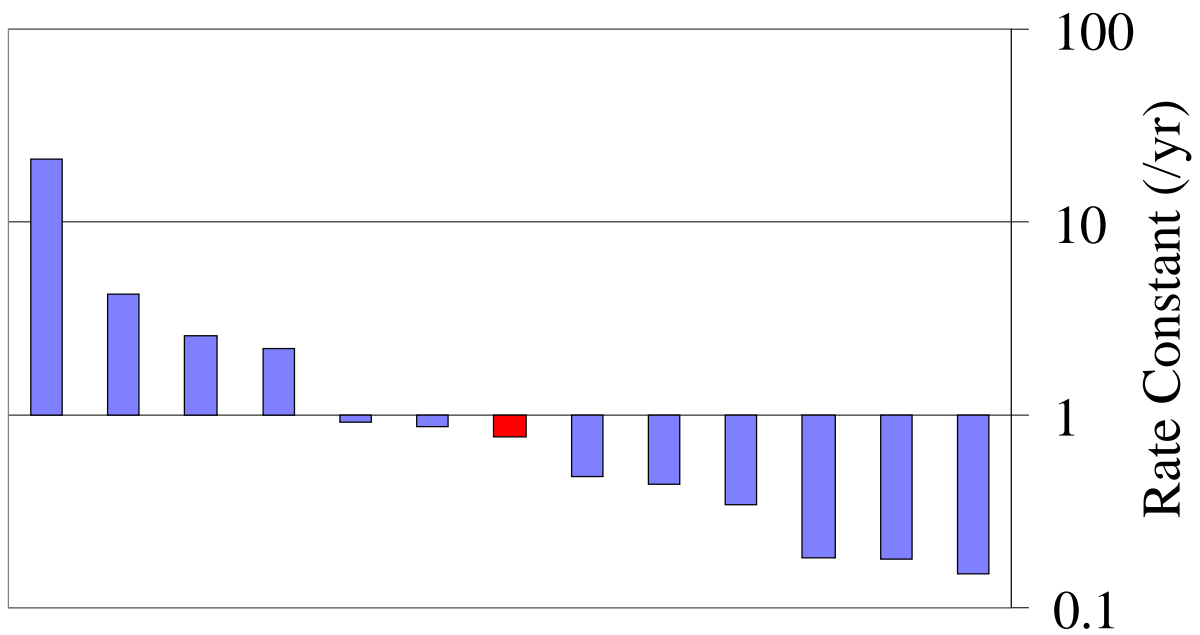

Figure C.3.6 Field rate constants for PCE as reported in literature.

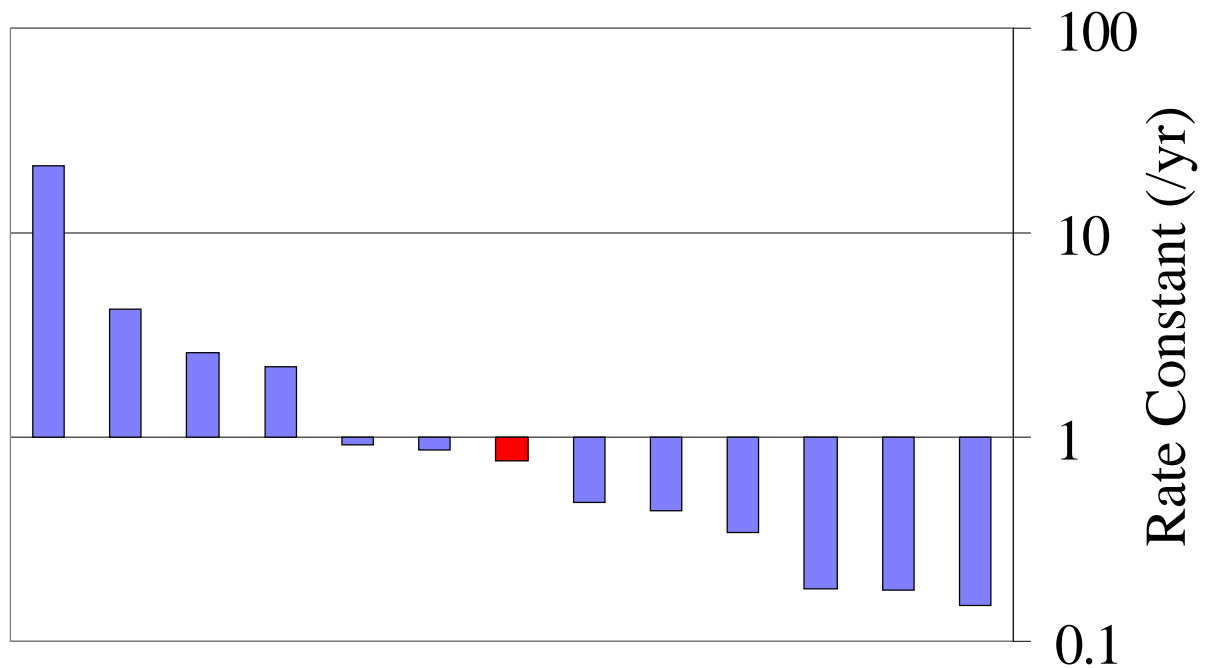

Figure C.3.7 Field rate constants for vinyl chloride as reported in literature.

C.3.3.3.2 Use of a Normalized Data Set

In order to ensure that observed decreases in contaminant concentrations can be attributed to biodegradation, measured contaminant concentrations must be corrected for the effects of advection, dispersion, dilution from recharge, and sorption, as described in Section C.3.3.2 using equation C.3.24. The corrected concentration of a compound is the concentration that would be expected at one point (B) located downgradient from another point (A) if the processes of dispersion and dilution had not been occurring between points A and B.

The biodegradation rate can be estimated between any two points (A and B) of a normalized data set (where point A is upgradient of point B) by substituting the concentration at point A for C_0 , and the normalized concentration at point B, $C_{B,corr}$, for C in equation C.3.27. The resulting relationship is expressed as:

$$C_{B,corr} = C_A e^{-\lambda t} \quad \text{eq. C.3.28}$$

Where:

- $C_{B,corr}$ = normalized contaminant concentration at downgradient point B (from eq. C.3.25)
- C_A = contaminant concentration at upgradient point A that if point A is the first point in the normalized data set, then $C_A = C_{A,corr}$
- λ = first-order biological decay rate (first-order rate constant) [1/T]
- t = time of contaminant travel between points A and B

The rate constant in this equation is no longer the total attenuation rate, k , but is the biological decay rate, λ , because the effects of advection, dispersion, dilution from recharge, and sorption have been removed (Section C.3.3.2). This relationship can be used to calculate the first-order biological decay rate constant between two points by solving equation C.3.28 for λ :

$$\lambda = -\frac{\ln\left(\frac{C_{B,corr}}{C_A}\right)}{t} \quad \text{eq. C.3.29}$$

The travel time, t , between two points is given by:

$$t = \frac{x}{v_c} \quad \text{eq. C.3.30}$$

Where:

x = distance between two points [L]

v_c = retarded solute velocity [L/T]

Example C.3.6: First-Order Decay Rate Constant Calculation Using Normalized Data Set

Equation C.3.30 and C.3.29 can be used to calculate rate constants between any two points along a flow line. For travel from locations T-2-5 and 55AE in Figure C.3.4 and Table C.3.6, the upgradient concentration of TCE is 12.1 mg/l, the corrected downgradient concentration is 0.051 mg/l, and the distance between the locations is 2,000 feet.

From Figure C.3.4, the water table drops 10 feet as the plume moves 1,300 feet from transect 1 to transect 5. The site has a hydraulic gradient of 0.008 feet per foot. Aquifer testing at the site predicts an average hydraulic conductivity of 50 feet per day. If the effective porosity of the sandy aquifer is assumed to be 0.3, the seepage velocity (V_x) would be (Equation C.3.6):

$$V_x = \frac{0.4 \text{ ft/day} \times 0.008 \text{ ft/ft}}{0.3} = 1.3 \text{ ft/day}$$

The average organic matter content of the aquifer matrix material is less than the detection limit of 0.001 g/g. We will assume the organic matter content is equal to the detection limit. If the K_{oc} of TCE is 120 ml/g, the porosity is 0.3, and the bulk density is 1.7 gm/cm³, the distribution of TCE between ground water and aquifer solids is the product of the K_{oc} , the fraction organic carbon, the bulk density, divided by the porosity, or 0.3. The retarded velocity of TCE compared to water (R) would be (Equation C.3.8 and Equation C.3.13):

$$R = 1 + 120 \text{ (ml/g)} * 0.001 \text{ (g/g)} * 1.7 \text{ (g/cm}^3\text{)} / 0.3 \text{ (ml/ml)} = 1.7$$

The velocity of TCE in the aquifer would be equal to the velocity of water in the plume divided by the retardation of TCE. The TCE velocity (v_c) would be:

$$v_c = 1.3 \text{ feet per day} / 1.7 = 0.8 \text{ feet per day}$$

If the distance between the wells is 2,000 feet, and the retarded velocity of TCE is 0.8 feet per day, by equation C.3.30 the travel time is:

$$t = 2,000 \text{ feet} / 0.8 \text{ feet per day} = 2,500 \text{ days} = 6.8 \text{ years}$$

From equation C.3.29, the rate of biotransformation between locations T-2-5 and 55AE is:

$$\lambda = \ln(0.055/12.1) / 6.8 \text{ per year} = 0.79 \text{ per year}$$

If a number of sampling locations are available along a flow path, all the locations should be included in the calculation of the biotransformation rate. The simplest way to determine the first-order rate constant from an entire set of normalized data is to make a log-linear plot of normalized contaminant concentrations versus travel time. If the data plot along a straight line, the relationship is first-order and an exponential regression analysis can be performed.

The exponential regression analysis gives the equation of the line of best fit for the data being regressed from a log-linear plot and has the general form:

$$y = be^{mx}$$

eq. C.3.31

Where:

- y = y axis value
- b = y intercept
- m = slope of regression line
- x = x-axis value

When using normalized data, x is the contaminant travel time to the downgradient locations and m is the first-order rate of change equal to the negative. The correlation coefficient, R^2 , is a measure of how well the regression relationship approximates the data. Values of R^2 can range from 0 to 1; the closer R^2 is to 1, the more accurate the equation describing the trend in the data. Values of R^2 greater than 0.80 are generally considered useful; R^2 values greater than 0.90 are considered excellent. Several commonly available spreadsheets can be used to facilitate the exponential regression analysis. The following example illustrates the use of this technique.

Figure C.3.8 depicts a regression of normalized TCE concentration against travel time downgradient. The slope of the exponential regression is $-0.824x$ where x is travel time in years, corresponding to a first-order rate of change of -0.824 per year and a first-order rate of biodegradation of 0.824 per year. In Figure C.3.8, an exponential regression was performed on the normalized concentrations of TCE against time of travel along the flow path. An alternative approach would be to perform a linear regression of the natural logarithm of the normalized concentration of TCE against travel time along the flow path.

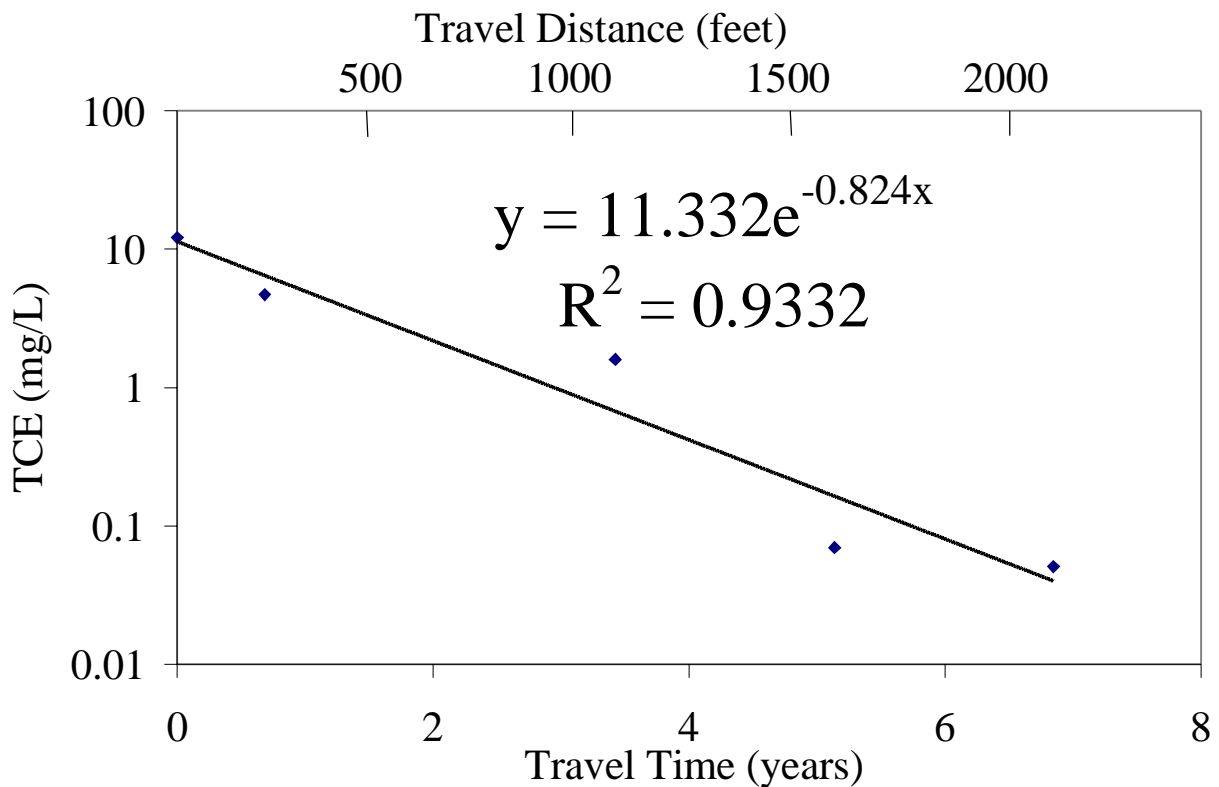

Figure C.3.8 Exponential regression of TCE concentration on time of travel along flow path.

C.3.3.3.3. Method of Buscheck and Alcantar (1995)

Buscheck and Alcantar (1995) derive a relationship that allows calculation of first-order decay rate constants for steady-state plumes. This method involves coupling the regression of contaminant concentration (plotted on a logarithmic scale) versus distance downgradient (plotted on a linear scale) to an analytical solution for one-dimensional, steady-state, contaminant transport that includes advection, dispersion, sorption, and biodegradation. For a steady-state plume, the first-order decay rate is given by (Buscheck and Alcantar, 1995):

$$\lambda = \frac{v_c}{4\alpha_x} \left(\left[1 + 2\alpha_x \left(\frac{k}{v_x} \right) \right]^2 - 1 \right) \quad \text{eq. C.3.32}$$

Where:

λ = first-order biological rate constant

v_c = retarded contaminant velocity in the x-direction

α_x = dispersivity

k/v_x = slope of line formed by making a ln-linear plot of contaminant concentration versus distance downgradient along flow path

Example C.3.7: First-Order Rate Constant Calculation Using Method of Buscheck and Alcantar (1995)

The first step is to confirm that the contaminant plume has reached a steady-state configuration. This is done by analyzing historical data to make sure that the plume is no longer migrating downgradient and that contaminant concentrations are not changing significantly through time. This is generally the case for older spills where the source has not been removed. The next step is to make a plot of the natural logarithm of contaminant concentration versus distance downgradient (see Figure C.3.9). Using linear regression, y in the regression analysis is the contaminant concentration, x is the distance downgradient from the source, and the slope of the ln-linear regression is the ratio k/v_x that is entered into equation C.3.32.

The slope is -0.0028 feet. As calculated above, the retarded TCE velocity in the plume v_c is 0.8 feet per day. If $\alpha_x = 5\%$ of the plume length, then $\alpha_x = 100$ feet. Inserting these values for α_x , k/v_x , and v_c into equation C.3.32, the estimated value of $\lambda = -0.0016$ per day or -0.59 per year.

C.3.3.2.2.3 Comparison of First-Order Methods

If the data are available, concentrations of tracers should be used to normalize concentrations of contaminants prior to calculation of rate constants. If tracer data is not available, the method of Buscheck and Alcantar (1995) can be used if a value for longitudinal dispersion is available, or if one is willing to assume a value for longitudinal dispersion. Whenever possible, more than one tracer should be used to normalize the concentrations of contaminants. If the normalized concentrations agree using several different tracers, the approach can be accepted with confidence. In addition to chloride and trimethylbenzene, methane, and total organic carbon dissolved in ground water are often useful tracers in plumes of chlorinated solvents undergoing natural attenuation.

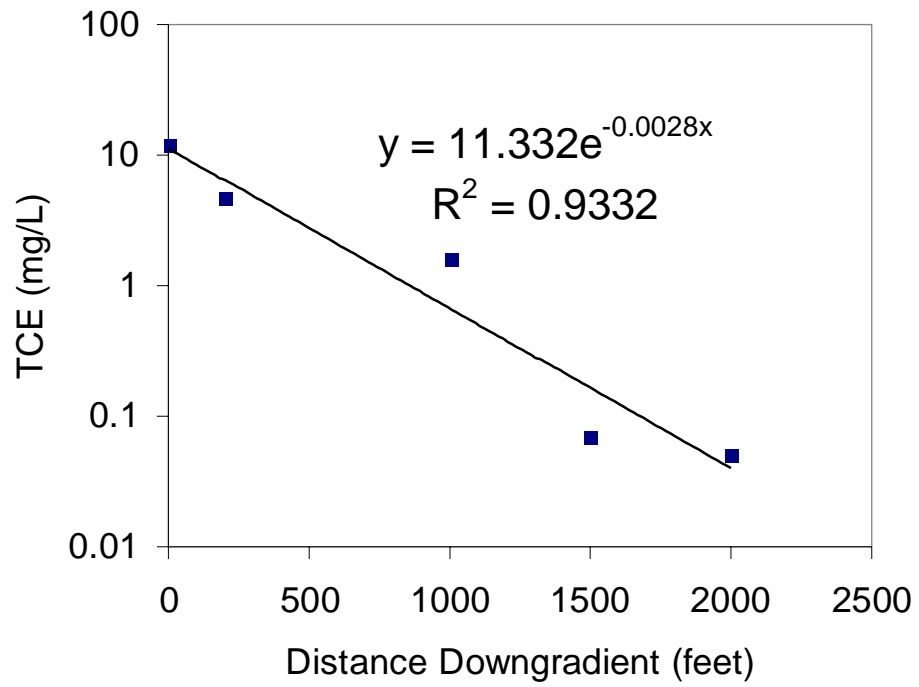

Figure C.3.9 Regression of the TCE concentration on distance along flow path.

C.3.4 DESIGN, IMPLEMENTATION, AND INTERPRETATION OF MICROCOSM STUDIES

C.3.4.1 Overview

If properly designed, implemented, and interpreted, microcosm studies can provide very convincing documentation of the occurrence of intrinsic bioremediation. They are the only “line of evidence” that allows an unequivocal mass balance on the biodegradation of environmental contaminants. If the microcosm study is properly designed, it will be easy for decision makers with non-technical backgrounds to interpret. The results of a microcosm study are strongly influenced by the nature of the geological material submitted to study, by the physical properties of the microcosm, by the sampling strategy, and the duration of the study. In addition, microcosm studies are time consuming and expensive. A microcosm study should only be undertaken at sites where there is considerable uncertainty concerning the biodegradation of contaminants based on soil and ground-water samples alone.

Material for a microcosm study should not be selected until the geochemical behavior of the site is well understood. Contaminant plumes may consume oxygen, nitrate, or sulfate, and produce iron (II), manganese (II), or methane. These processes usually operate concurrently in different parts of the plume. Regions where each process prevails may be separated in directions parallel to ground-water flow by hundreds of meters, in directions perpendicular to ground-water flow by tens of meters, and vertically by only a few meters. Rate constants and constraints for petroleum hydrocarbon biodegradation will be influenced by the prevailing geochemistry. Material from microcosms must be acquired for depth intervals and locations that have been predetermined to be representative of the prevailing geochemical milieu in the plume.

Contaminant biodegradation supported by oxygen and nitrate cannot be adequately represented in microcosm. In the field, organisms that use oxygen or nitrate proliferate until they become limited by the supply of electron acceptor. After that time, the rate of hydrocarbon degradation is controlled by the supply of electron acceptor through diffusion or hydrodynamic dispersion. Microcosms have been used successfully to simulate sulfate-reducing, iron-reducing, and methanogenic regions of plumes. Oxygen is toxic to sulfate-reducing and methanogenic microorganisms. Material should be collected and secured in a manner that precludes oxygenation of the sample.

Batch microcosms that are sacrificed for each analysis usually give more interpretable results than column microcosms or batch microcosms that are sampled repetitively. For statistical reasons, at least three microcosms should be sampled at each time interval. If one assumes a first-order rate law, and no lag, a geometrical time interval for sampling should be the most efficient. An example would be sampling after 0 weeks, 2 weeks, 1 month, 2 months, 4 months, and 8 months. As a practical matter, long lags frequently occur, and the rate of bioremediation after the lag is rapid. A simple linear time scale is most likely to give interpretable results.

The batch microcosms should have approximately the same ratio of solids to water as the original material. Most of the microbes are attached to solids. If a microcosm has an excess of water, and the contaminant is mostly in the aqueous phase, the microbes must process a great deal more contaminant to produce the same relative change in the contaminant concentration as would be obtained at field scale. The kinetics at field scale would be underestimated.

Microcosms are inherently time consuming. At field scale, the residence time of a plume may be several years to decades. Slow rates of transformation may have a considerable environmental significance. A microcosm study that lasts only a few weeks or months may not have the resolution to detect slow changes that are still of environmental significance. Further, microcosms often show a pattern of sequential utilization, with toluene and the xylenes degrading first, and benzene and ethylbenzene degrading at a later time. Degradation of benzene or ethylbenzene may be delayed by as much as a year.

As a practical matter, batch microcosms with an optimal solids-to-water ratio, sampled every 2 months in triplicate for up to 18 months, can resolve biodegradation from abiotic losses with a rate detection limit of 0.001 to 0.0005 per day. Many plumes show significant attenuation of contamination at field-calibrated rates that are slower than the detection limit of today's microcosm technology. The most appropriate use of microcosms is to document that contaminant attenuation is largely a biological process. Rate constants for modeling purposes are more appropriately acquired from field-scale studies.

Microcosm studies are often used to provide a third line of evidence. The potential for biodegradation of the contaminants of interest can be confirmed by the use of microcosms, through comparison of removals in the living treatments with removals in the controls. Microcosm studies also permit an absolute mass balance determination based on biodegradation of the contaminants of interest. Further, the appearance of daughter products in the microcosms can be used to confirm biodegradation of the parent compound.

C.3.4.2 When to Use Microcosms

There are two fundamentally different applications of microcosms. They are frequently used in a qualitative way to illustrate the important processes that control the fate of organic contaminants. They are also used to estimate rate constants for biotransformation of contaminants that can be used in a site-specific transport and fate model of a plume of contaminated groundwater. This paper only discusses microcosms for the second application.

Microcosms should be used when there is no other way to obtain a rate constant for attenuation of contaminants, in particular, when it is impossible to estimate the rate of attenuation from data from monitoring wells in the plume of concern. There are situations where it is impossible to compare concentrations in monitoring wells along a flow path due to legal or physical impediments. In many landscapes, the direction of ground-water flow (and water table elevations in monitoring wells) can vary over short periods of time due to tidal influences or changes in barometric pressure. The direction of ground-water flow may also be affected by changes in the stage of a nearby river or pumping wells in the vicinity. These changes in ground-water flow direction do not allow simple snap-shot comparisons of concentrations in monitoring wells because of uncertainties in identifying the flow path. Rate constants from microcosms can be used with average flow conditions to estimate attenuation at some point of discharge or point of compliance.

C.3.4.3 Application of Microcosms

The primary objective of microcosm studies is to obtain rate constants applicable to average flow conditions. These average conditions can be determined by continuous monitoring of water table elevations in the aquifer being evaluated. The product of the microcosm study and the continuous monitoring of water table elevations will be a yearly or seasonal estimate of the extent of attenuation along average flow paths. Removals seen at field scale can be attributed to biological activity. If removals in the microcosms duplicate removal at field scale, the rate constant can be used for risk assessment purposes (B.H. Wilson *et al.*, 1996; Bradley, *et al.*, 1998).

C.3.4.4 Selecting Material for Study

Prior to choosing material for microcosm studies, the location of major conduits of ground-water flow should be identified and the geochemical regions along the flow path should be determined. The important geochemical regions for natural attenuation of chlorinated aliphatic hydrocarbons are regions that are actively methanogenic; regions that exhibit sulfate reduction and iron reduction concomitantly; and regions that exhibit iron reduction alone. The pattern of biodegradation of chlorinated solvents varies in different regions. Vinyl chloride tends to accumulate during reductive dechlorination of TCE or PCE in methanogenic regions (Weaver *et al.*, 1995; J.T. Wilson *et al.*, 1995); it does not accumulate to the same extent in regions exhibiting iron reduction and

sulfate reduction (Chapelle, 1996). In regions showing iron reduction alone, vinyl chloride is consumed but dechlorination of PCE, TCE, or DCE may not occur (Bradley and Chapelle, 1996;1997). Core material from each geochemical region in major flow paths represented by the plume must be acquired, and the hydraulic conductivity of each depth at which core material is acquired must be measured. If possible, the microcosms should be constructed with the most transmissive material in the flow path.

Several characteristics of ground water from the same interval used to collect the core material should be determined. These characteristics include temperature, redox potential, pH, and concentrations of oxygen, sulfate, sulfide, nitrate, iron II, chloride, methane, ethane, ethene, total organic carbon, and alkalinity. The concentrations of compounds of regulatory concern and any breakdown products for each site must be determined. The ground water should be analyzed for methane to determine if methanogenic conditions exist and for ethane and ethene as daughter products from reductive dechlorination of PCE and TCE. A comparison of the ground-water chemistry from the interval where the cores were acquired to that in neighboring monitoring wells will demonstrate if the collected cores are representative of that section of the contaminant plume.

Reductive dechlorination of chlorinated solvents requires an electron donor to allow the process to proceed. The electron donor could be soil organic matter, low molecular weight organic compounds (lactate, acetate, methanol, glucose, etc.), H₂, or a co-contaminant such as landfill leachate or petroleum compounds (Bouwer, 1994; Sewell and Gibson, 1991; Klecka *et al.*, 1996). In many instances, the actual electron donor(s) may not be identified.

Several characteristics of the core material should also be evaluated. The initial concentration of the contaminated material (on a mass per mass basis) should be identified prior to construction of the microcosms. Also, it is necessary to know if the contamination is present as a nonaqueous phase liquid (NAPL) or in solution. A total petroleum hydrocarbon (TPH) analysis will determine if any hydrocarbon-based oily materials are present. The water-filled porosity is a parameter generally used to extrapolate rates to the field. It can be calculated by comparing wet and dry weights of the aquifer material.

To insure sample integrity and stability during acquisition, it is important to quickly transfer the aquifer material into a jar, exclude air by adding ground water, and seal the jar without headspace. The material should be cooled during transportation to the laboratory. Incubate the core material at the ambient ground-water temperature in the dark before the construction of microcosms.

At least one microcosm study per geochemical region should be completed. If the plume is over one kilometer in length, several microcosm studies per geochemical region may need to be constructed.

C.3.4.5 Geochemical Characterization of the Site

The geochemistry of the subsurface affects behavior of organic and inorganic contaminants, inorganic minerals, and microbial populations. Major geochemical parameters that characterize the subsurface encompasses (1) pH; (2) ORP; (3) alkalinity; (4) physical and chemical characterization of the solids; (5) temperature; (6) dissolved constituents, including electron acceptors; and (7) microbial processes. The most important of these in relation to biological processes are redox potential, alkalinity, concentration of electron acceptor, and chemical nature of the solids.

Alkalinity: Field indications of biologically active portions of a plume may be identified by increased alkalinity, compared to background wells, from carbon dioxide due to biodegradation of the pollutants. Increases in both alkalinity and decrease in pH have been measured in portions of an aquifer contaminated by gasoline undergoing active utilization of the gasoline components (Cozzarelli *et al.*, 1995). Alkalinity can be one of the parameters used when identifying where to collect biologically active core material.

pH: Bacteria generally prefer a neutral or slightly alkaline pH level with an optimum pH range for most microorganisms between 6.0 and 8.0; however, many microorganisms can tolerate a pH range of 5.0 to 9.0. Most ground waters in uncontaminated aquifers are within these ranges. Natural pH values may be as low as 4.0 or 5.0 in aquifers with active oxidation of sulfides, and pH values as high as 9.0 may be found in carbonate-buffered systems (Chapelle, 1993). However, pH values as low as 3.0 have been measured for ground waters contaminated with municipal waste leachates which often contain elevated concentrations of organic acids (Baedecker and Back, 1979). In ground waters contaminated with sludges from cement manufacturing, pH values as high as 11.0 have been measured (Chapelle, 1993).

ORP: The ORP of ground water is a measure of electron activity that indicates the relative ability of a solution to accept or transfer electrons. Most redox reactions in the subsurface are microbially catalyzed during metabolism of native organic matter or contaminants. The only elements that are predominant participants in aquatic redox processes are carbon, nitrogen, oxygen, sulfur, iron, and manganese (Stumm and Morgan, 1981). The principal oxidizing agents in ground water are oxygen, nitrate, sulfate, manganese (IV), and iron (III). Biological reactions in the subsurface both influence and are affected by the redox potential and the available electron acceptors. The redox potential changes with the predominant electron acceptor, with reducing conditions increasing through the sequence oxygen, nitrate, iron, sulfate, and carbonate. The redox potential decreases in each sequence, with methanogenic (carbonate as the electron acceptor) conditions being most reducing. The interpretation of redox potentials in ground waters is difficult (Snoeyink and Jenkins, 1980). The potential obtained in ground waters is a mixed potential that reflects the potential of many reactions and cannot be used for quantitative interpretation (Stumm and Morgan, 1981). The approximate location of the contaminant plume can be identified in the field by measurement of the redox potential of the ground water.

To overcome the limitations imposed by traditional redox measurements, recent work has focused on the measurement of molecular hydrogen to accurately describe the predominant *in situ* redox reactions (Chapelle *et al.*, 1995; Lovley *et al.*, 1994; Lovley and Goodwin, 1988). The evidence suggests that concentrations of H₂ in ground water can be correlated with specific microbial processes, and these concentrations can be used to identify zones of methanogenesis, sulfate reduction, and iron reduction in the subsurface (Chapelle, 1996).

Electron Acceptors: Measurement of the available electron acceptors is critical in identifying the predominant microbial and geochemical processes occurring *in situ* at the time of sample collection. Nitrate and sulfate are found naturally in most ground waters and will subsequently be used as electron acceptors once oxygen is consumed. Oxidized forms of iron and manganese can be used as electron acceptors before sulfate reduction commences. Iron and manganese minerals solubilize coincidentally with sulfate reduction, and their reduced forms scavenge oxygen to the extent that strict anaerobes (some sulfate reducers and all methanogens) can develop. Sulfate is found in many depositional environments, and sulfate reduction may be very common in many contaminated ground waters. In environments where sulfate is depleted, carbonate becomes the electron acceptor with methane gas produced as an end product.

Temperature: The temperature at all monitoring wells should be measured to determine when the pumped water has stabilized and is ready for collection. Below approximately 30 feet, the temperature in the subsurface is fairly consistent on an annual basis. Microcosms should be stored at the average *in situ* temperature. Biological growth can occur over a wide range of temperatures, although most microorganisms are active primarily between 10°C and 35°C (50°F to 95°F).

Chloride: Reductive dechlorination results in the accumulation of inorganic chloride. In aquifers with a low background of inorganic chloride, the concentration of inorganic chloride should

increase as the chlorinated solvents are degraded. The sum of the inorganic chloride plus the chloride in the contaminant being degraded should remain relatively consistent along the ground water flow path.

Tables C.3.7 and C.3.8 list the geochemical parameters, contaminants, and daughter products that should be measured during site characterization for natural attenuation. The tables include the analyses that should be performed, the optimum range for natural attenuation of chlorinated solvents, and the interpretation of the value in relation to biological processes.

Table C.3.7 *Geochemical Parameters Important to Microcosm Studies*

Analysis	Range	Interpretation
Redox Potential	<50 millivolt against Ag/AgCl	Reductive pathway possible
Sulfate	<20 mg/L	Competes at higher concentrations with reductive pathway
Nitrate	<1 mg/L	Competes at higher concentrations with reductive pathway
Oxygen	<0.5 mg/L	Tolerated, toxic to reductive pathway at higher concentrations
Oxygen	>1 mg/L	Vinyl chloride oxidized
Iron (II)	>1 mg/L	Reductive pathway possible
Sulfide	>1 mg/L	Reductive pathway possible
Hydrogen	>1 nM	Reductive pathway possible, vinyl chloride may accumulate
Hydrogen	<1 nM	Vinyl chloride oxidized
pH	5 < pH < 9	Tolerated range

Table C.3.8 *Contaminants and Daughter Products Important to Microcosm Studies*

Analysis	Interpretation
PCE	Material spilled
TCE	Material spilled or daughter product of PCE
1,1,1-TCA	Material spilled
<i>cis</i> -1,2-DCE	Daughter product of TCE
<i>trans</i> -1,2-DCE	Daughter product of TCE
Vinyl Chloride	Daughter product of dichloroethylenes
Ethene	Daughter product of vinyl chloride
Ethane	Daughter product of ethene
Methane	Ultimate reductive daughter product
Chloride	Daughter product of organic chlorine
Carbon Dioxide	Ultimate oxidative daughter product
Alkalinity	Results from interaction of carbon dioxide with aquifer minerals

C.3.4.6 Microcosm Construction

During construction of the microcosms, it is best if all manipulations take place in an anaerobic glovebox. These gloveboxes exclude oxygen and provide an environment where the integrity of the core material may be maintained, since many strict anaerobic bacteria are sensitive to oxygen. Stringent aseptic precautions not necessary for microcosm construction. It is more important to maintain anaerobic conditions of the aquifer material and solutions added to the microcosm bottles.

The microcosms should have approximately the same ratio of solids to water as the *in situ* aquifer material, with a minimum or negligible headspace. Most bacteria in the subsurface are attached to the aquifer solids. If a microcosm has an excess of water, and the contaminant is primarily in the dissolved phase, the bacteria must consume or transform a great deal more contaminant to produce the same relative change in the contaminant concentration. As a result, the kinetics of removal at field scale will be underestimated in the microcosms.

A minimum of three replicate microcosms for both living and control treatments should be constructed for each sampling event. Microcosms sacrificed at each sampling interval are preferable to microcosms that are repetitively sampled. The compounds of regulatory interest should be added at concentrations representative of the higher concentrations found in the geochemical region of the plume being evaluated. The compounds should be added as a concentrated aqueous solution. If an aqueous solution is not feasible, dioxane or acetonitrile may be used as solvents. Avoid carriers that can be metabolized anaerobically, particularly alcohols. If possible, use ground water from the site to prepare dosing solutions and to restore water lost from the core barrel during sample collection.

For long-term microcosm studies, autoclaving is the preferred method for sterilization. Nothing available to sterilize core samples works perfectly. Mercuric chloride is excellent for short-term studies (weeks or months). However, mercuric chloride complexes to clays, and control may be lost as it is sorbed over time. Sodium azide is effective in repressing metabolism of bacteria that have cytochromes, but is not effective on strict anaerobes.

The microcosms should be incubated in the dark at the ambient temperature of the aquifer. It is preferable that the microcosms be incubated inverted in an anaerobic glovebox. Anaerobic jars are also available that maintain an oxygen-free environment for the microcosms. Dry redox indicator strips can be placed in the jars to assure that anoxic conditions are maintained. If no anaerobic storage is available, the inverted microcosms can be immersed in approximately two inches of water during incubation. Teflon[®]-lined butyl rubber septa are excellent for excluding oxygen and should be used if the microcosms must be stored outside an anaerobic environment.

The studies should last from one year to eighteen months. The residence time of a plume may be several years to tens of years at field scale. Rates of transformation that are slow in terms of laboratory experimentation may have a considerable environmental significance. A microcosm study lasting only a few weeks to months may not have the resolution to detect slow changes that are of environmental significance. Additionally, microcosm studies often distinguish a pattern of sequential biodegradation of the contaminants of interest and their daughter products.

C.3.4.7 Microcosm Interpretation

As a practical matter, batch microcosms with an optimal solids/water ratio, that are sampled every two months in triplicate, for up to eighteen months, can resolve biodegradation from abiotic losses with a detection limit of 0.001 to 0.0005 per day. Rates determined from replicated batch microcosms are found to more accurately duplicate field rates of natural attenuation than column studies. Many plumes show significant attenuation of contamination at field calibrated rates that are slower than the detection limit of microcosms. Although rate constants for modeling purposes are more appropriately acquired from field-scale studies, it is reassuring when the rates in the field and the rates in the laboratory agree.

The rates measured in the microcosm study may be faster than the estimated field rate. This may not be due to an error in the laboratory study, particularly if estimation of the field-scale rate of attenuation did not account for regions of preferential flow in the aquifer. The regions of preferential flow may be determined by use of a downhole flow meter or by other methods for determining hydraulic conductivity in one- to two-foot sections of the aquifer.

Statistical comparisons can determine if removals of contaminants of concern in the living treatments are significantly different from zero or significantly different from any sorption that is occurring. Comparisons are made on the first-order rate of removal, that is, the slope of a linear regression of the natural logarithm of the concentration remaining against time of incubation for both the living and control microcosm. These slopes (removal rates) are compared to determine if they are different, and if so, extent of difference that can be detected at a given level of confidence.

C.3.4.8 The Tibbetts Road Case Study

The Tibbetts Road Superfund Site in Barrington, New Hampshire, a former private home, was used to store drums of various chemicals from 1944 to 1984. The primary ground-water contaminants in the overburden and bedrock aquifers were benzene and TCE, with respective concentrations of 7,800 µg/L and 1,100 µg/L. High concentrations of arsenic, chromium, nickel, and lead were also found.

Material collected at the site was used to construct a microcosm study evaluating the removal of benzene, toluene, and TCE. This material was acquired from the most contaminated source at the site, the waste pile near the origin of Segment A (Figure C.3.10). Microcosms were incubated for nine months. The aquifer material was added to 20-mL headspace vials, dosed with 1 mL of spiking solution, capped with a Teflon[®]-lined, gray butyl rubber septa, and sealed with an aluminum crimp cap. Controls were prepared by autoclaving the material used to construct the microcosms overnight. Initial concentrations for benzene, toluene, and TCE were, respectively, 380 µg/L, 450 µg/L, and 330 µg/L. The microcosms were thoroughly mixed by vortexing, then stored inverted in the dark at the ambient temperature of 10°C.

The results (Figures C.3.11, C.3.12, and C.3.13; Table C.3.9) show that significant biodegradation of both petroleum aromatic hydrocarbons and the chlorinated solvent had occurred. Significant removal in the control microcosms also occurred for all compounds. The data exhibited more variability in the living microcosms than in the control treatment, which is a pattern that has been observed in other microcosm studies. The removals observed in the controls are probably due to sorption; however, this study exhibited more sorption than typically seen.

The rate constants determined from the microcosm study for the three compounds are shown in Table C.3.10. The appropriate rate constant to be used in a model or a risk assessment would be the first-order removal in the living treatment minus the first-order removal in the control, in other words the removal that is in excess of the removal in the controls.

The first-order removal in the living and control microcosms was estimated as the linear regression of the natural logarithm of concentration remaining in each microcosm in each treatment against time of incubation. Student's *t*-distribution with *n*-2 degrees of freedom was used to estimate the 95% confidence interval. The standard error of the difference of the rates of removal in living and control microcosms was estimated as the square root of the sum of the squares of the standard errors of the living and control microcosms, with *n*-4 degrees of freedom (Glantz, 1992).

Table C.3.11 presents the concentrations of organic compounds and their metabolic products in monitoring wells used to define line segments in the aquifer for estimation of field-scale rate constants. Wells in this aquifer showed little accumulation of *trans*-1,2-DCE; 1,1-DCE; vinyl chloride; or ethene, although removals of TCE and *cis*-1,2-DCE were extensive. This can be explained by the observation (Bradley and Chapelle, 1996) that iron-reducing bacteria can rapidly oxidize vinyl chloride to carbon dioxide. Filterable iron accumulated in ground water in this aquifer.

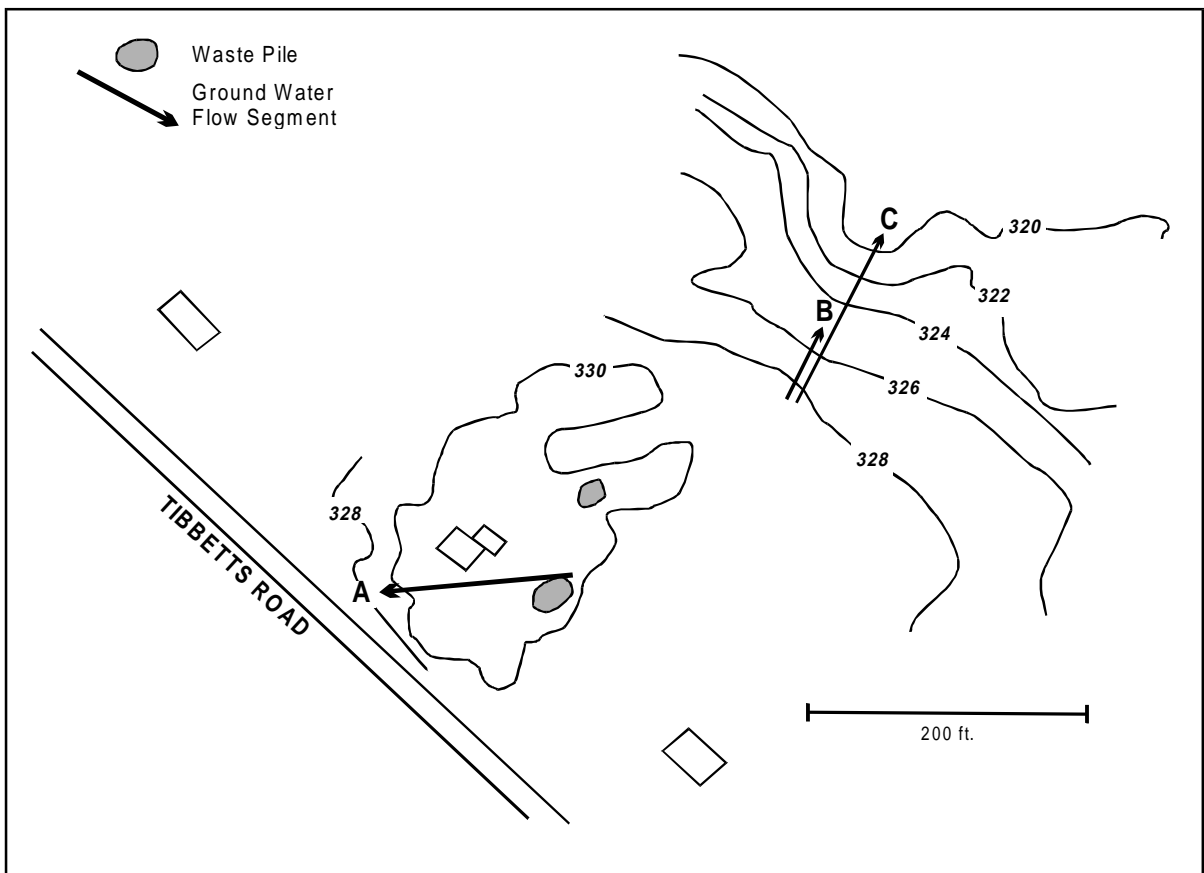

Figure C.3.10 Tibbetts Road study site.

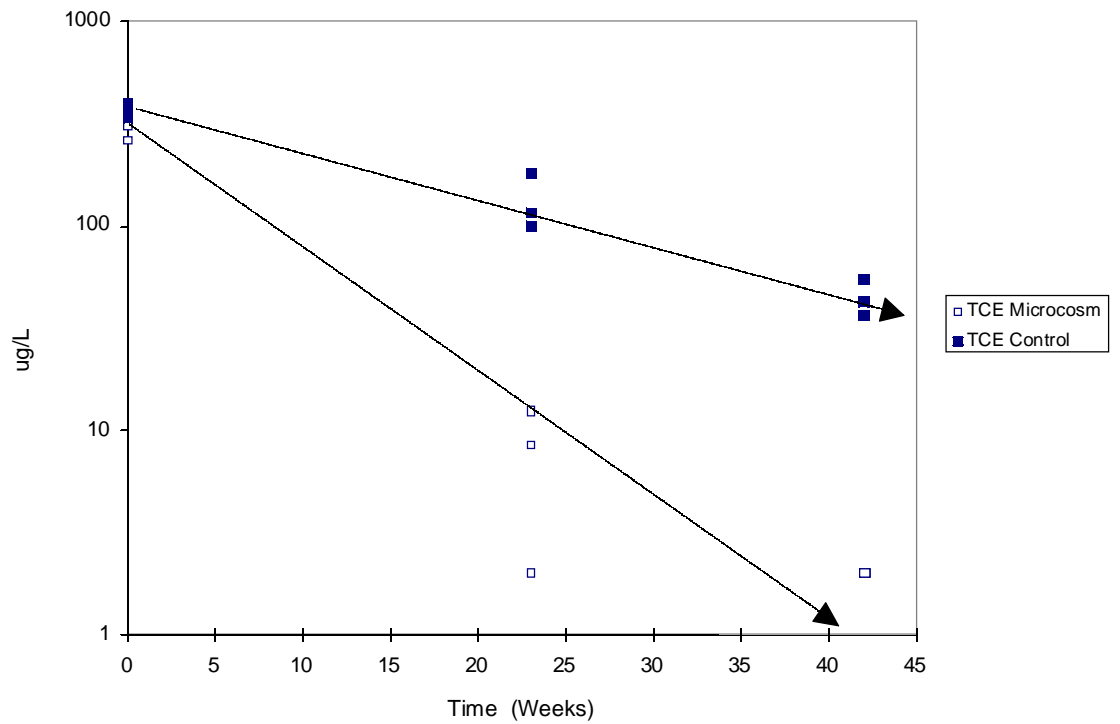

Figure C.3.11 TCE microcosm results.

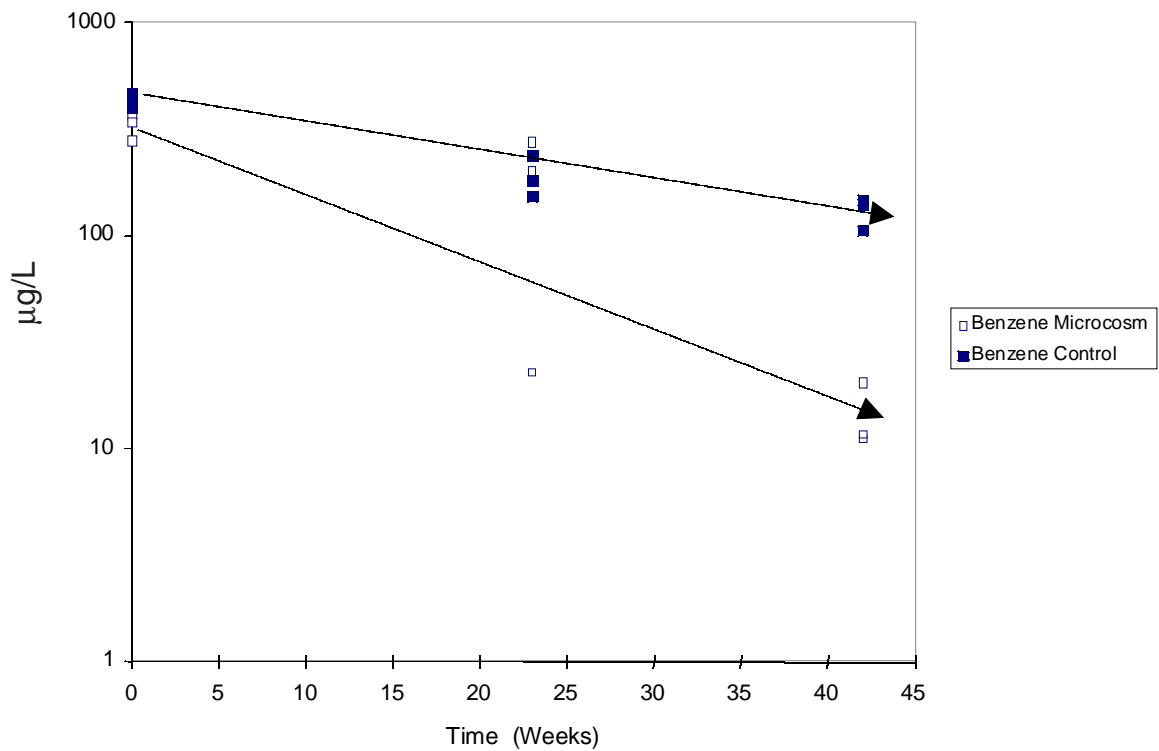

Figure C.3.12 Benzene microcosm results.

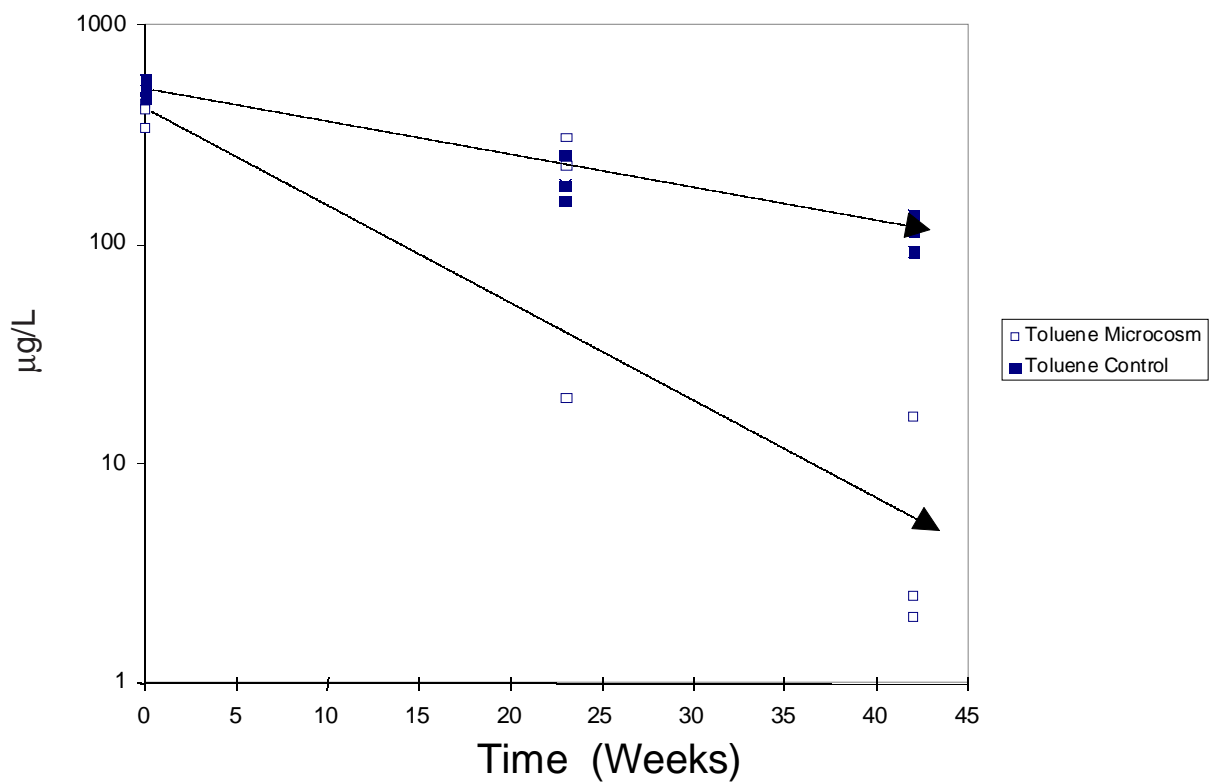

Figure C.3.13 Toluene microcosm results.

Table C.3.9 Concentrations ($\mu\text{g/L}$) of TCE, Benzene, and Toluene in the Tibbetts Road Microcosms

Compound	Time Zero Microcosm	Time Zero Control	Week 23 Microcosm	Week 23 Control	Week 42 Microcosm	Week 42 Control
TCE	328	337	1	180	2	36.3
	261	394	12.5	116	2	54.5
	309	367	8.46	99.9	2	42.3
Mean \pm Standard Deviation	299 \pm 34.5	366 \pm 28.5	7.32 \pm 5.83	132 \pm 42.4	2.0 \pm 0.0	44.4 \pm 9.27
Benzene	366	396	201	236	11.1	146
	280	462	276	180	20.5	105
	340	433	22.8	152	11.6	139
Mean \pm Standard Deviation	329 \pm 44.1	430 \pm 33.1	167 \pm 130	189 \pm 42.8	14.4 \pm 5.29	130 \pm 21.9
Toluene	443	460	228	254	2	136
	342	557	304	185	2.5	92
	411	502	19.9	157	16.6	115
Mean \pm Standard Deviation	399 \pm 51.6	506 \pm 48.6	184 \pm 147	199 \pm 49.9	7.03 \pm 8.29	114 \pm 22.0

The extent of attenuation from well to well listed in Table C.3.11, and the travel time between wells in a segment (Figure C.3.4) were used to calculate first-order rate constants for each segment (Table C.3.12). Travel time between monitoring wells was calculated from site-specific estimates of hydraulic conductivity and from the hydraulic gradient. In the area sampled for the microcosm study, the estimated Darcy flow was 2.0 feet per year. With an estimated porosity in this particular glacial till of 0.1, this corresponds to a plume velocity of 20 feet per year.

C.3.4.9 Summary

Table C.3.13 compares the first-order rate constants estimated from the microcosm studies to the rate constants estimated at field scale. The agreement between the independent estimates of rate is good; indicating that the rates can appropriately be used in a risk assessment. The rates of biodegradation documented in the microcosm study could easily account for the disappearance of trichloroethylene, benzene, and toluene observed at field scale. The rates estimated from the microcosm study are several-fold higher than the rates estimated at field scale. This may reflect an underestimation of the true rate in the field. The estimates of plume velocity assumed that the aquifer was homogeneous. No attempt was made in this study to correct the estimate of plume velocity for the influence of preferential flow paths. Preferential flow paths with a higher hydraulic conductivity than average would result in a faster velocity of the plume, thus a lower residence time and faster rate of removal at field scale.

Table C.3.10 First-order Rate Constants for Removal of TCE, Benzene, and Toluene in the Tibbetts Road Microcosms

Parameter	Living Microcosms	Autoclaved Controls	Removal Above Controls
First-order Rate of Removal (per year)			
TCE	6.31	2.62	3.69
95% Confidence Interval	± 2.50	± 0.50	± 2.31
Minimum Rate Significant at 95% Confidence			1.38
Benzene	3.87	1.51	2.36
95% Confidence Interval	± 1.96	± 0.44	± 1.83
Minimum Rate Significant at 95% Confidence			0.53
Toluene	5.49	1.86	3.63
95% Confidence Interval	± 2.87	± 0.45	± 2.64
Minimum Rate Significant at 95% Confidence			0.99

Table C.3.11 Concentrations of Contaminants and Metabolic By-products in Monitoring Wells along Segments in the Plume used to Estimate Field-scale Rate Constants

Parameter Monitoring Well	Segment A		Segment B		Segment C	
	80S	79S	70S	52S	70S	53S
	Upgradient	Downgradient	Up gradient	Down gradient	Upgradient	Down gradient
-----($\mu\text{g/liter}$)-----						
TCE	200	13.7	710	67	710	3.1
cis-1,2-DCE	740	10.9	220	270	220	2.9
trans-1,2-DCE	0.41	<1	0.8	0.3	0.8	<1
1,1-DCE	0.99	<1	<1	1.6	<1	<1
Vinyl Chloride	<1	<1	<1	<1	<1	<1
Ethene	<4	<4	7	<4	7	<4
Benzene	510	2.5	493	420	493	<1
Toluene	10000	<1	3850	900	3850	<1
o-Xylene	1400	8.4	240	71	240	<1
m-Xylene	2500	<1	360	59	360	<1
p-Xylene	1400	22	1100	320	1100	<1
Ethylbenzene	1300	0.7	760	310	760	<1
Methane	353	77	8	3	8	<2
Iron						27000

Table C.3.12 First-order Rate Constants for Contaminant Attenuation in Segments of the Tibbetts Road Plume

Flow Path Segments in Length and Time of Ground-water Travel			
	Segment A 130 feet = 6.5 years	Segment B 80 feet = 4.0 years	Segment C 200 feet = 10 years
Compound	First-order Rate Constants in Segments (per year)		
TCE	0.41	0.59	0.54
<i>cis</i> -1,2-DCE	0.65	produced	0.43
Benzene	0.82	0.04	>0.62
Toluene	>1.42	0.36	>0.83
<i>o</i> -Xylene	0.79	0.30	>0.55
<i>m</i> -Xylene	>1.20	0.45	>0.59
<i>p</i> -Xylene	0.64	0.31	>0.70
Ethylbenzene	1.16	0.22	>0.66

Table C.3.13 Comparison of First-order Rate Constants in a Microcosm Study, and in the Field, at the Tibbetts Road NPL Site

Parameter	Microcosms Corrected for Controls		Field Scale		
	Average Rate	Minimum Rate Significant at 95% Confidence	Segment A	Segment B	Segment C
	-----First-order Rate (per year)-----				
Trichloroethylene	3.69	1.38	0.41	0.59	0.54
Benzene	2.36	0.53	0.82	0.04	>0.62
Toluene	3.63	0.99	>1.42	0.36	>0.83