

OSWER Publication 9200.2-154

OSWER TECHNICAL GUIDE FOR ASSESSING  
AND MITIGATING THE VAPOR INTRUSION  
PATHWAY FROM SUBSURFACE VAPOR  
SOURCES TO INDOOR AIR

U.S. Environmental Protection Agency

Office of Solid Waste and Emergency Response

June 2015

## **DISCLAIMER**

This document presents current technical recommendations of the U.S. Environmental Protection Agency (EPA) based on our current understanding of vapor intrusion into indoor air from subsurface vapor sources. This guidance document does not impose any requirements or obligations on the EPA, the states or tribal governments, or the regulated community. Rather, the sources of authority and requirements for addressing subsurface vapor intrusion are the relevant statutes and regulations. Decisions regarding a particular situation should be made based upon statutory and regulatory authority. EPA decision-makers retain the discretion to adopt or approve approaches on a case-by-case basis that differ from this guidance document, where appropriate, as long as the administrative record supporting its decision provides an adequate basis and reasoned explanation for doing so.

**TABLE OF CONTENTS**

<b>DISCLAIMER.....</b>	<b>i</b>
<b>TABLE OF CONTENTS.....</b>	<b>ii</b>
<b>LIST OF FIGURES.....</b>	<b>vi</b>
<b>LIST OF TABLES.....</b>	<b>vi</b>
<b>LIST OF APPENDICES.....</b>	<b>vii</b>
<b>ACRONYMS AND ABBREVIATIONS.....</b>	<b>viii</b>
<b>1.0 INTRODUCTION.....</b>	<b>1</b>
1.1 Definition of Vapor Intrusion.....	1
1.2 Statutory Authorities.....	3
1.2.1 Taking Action with Limited Data under CERCLA and the NCP.....	4
1.2.2 Taking Action with Limited Data under RCRA Corrective Action.....	6
1.3 Scope and Recommended Uses of this Technical Guide.....	6
1.3.1 Petroleum Hydrocarbons.....	9
1.3.2 Nonresidential Buildings.....	10
1.4 Companion Documents and Technical Resources.....	10
1.4.1 Vapor Intrusion Screening Level Calculator.....	11
1.4.2 Technical Support Documents.....	11
1.5 Historical Context.....	12
1.6 Public Involvement in Developing Vapor Intrusion Technical Guide.....	16
1.7 Organization.....	16
<b>2.0 CONCEPTUAL MODEL OF VAPOR INTRUSION.....</b>	<b>19</b>
2.1 Subsurface Vapor Sources.....	22
2.2 Subsurface Vapor Migration.....	24
2.3 Openings and Driving Forces for Soil Gas Entry into Buildings.....	26
2.4 Air Exchange and Mixing.....	30
2.5 Conceptual Model Scenarios.....	31
2.6 Variability in Exposure Levels.....	34
2.7 Consideration of Indoor and Outdoor Sources of VOCs.....	34
<b>3.0 OVERVIEW OF VAPOR INTRUSION TECHNICAL GUIDE.....</b>	<b>36</b>
3.1 Contaminants of Potential Concern.....	36

3.2	Vapor Intrusion Assessment.....	37
3.3	Building Mitigation and Subsurface Remediation.....	41
3.4	Community Outreach and Involvement .....	44
<b>4.0</b>	<b>CONSIDERATIONS FOR NONRESIDENTIAL BUILDINGS.....</b>	<b>46</b>
<b>5.0</b>	<b>PRELIMINARY ANALYSIS OF VAPOR INTRUSION.....</b>	<b>49</b>
5.1	Assemble, Evaluate, and Review Available Information.....	49
5.2	Identify and Respond to Conditions that Warrant Prompt Action.....	51
5.3	Determine Presence of Structures and Vapor-forming Chemicals.....	52
5.4	Develop Initial Conceptual Site Model.....	55
5.5	Evaluating Pre-Existing and Readily Ascertainable Sampling Data.....	58
5.5.1	Evaluate Sampling Data Reliability and Quality.....	58
5.5.2	Evaluate Applicability of the VISLs and Adequacy of the Initial CSM.....	59
5.5.3	Preliminary Risk-based Screening.....	59
<b>6.0</b>	<b>DETAILED INVESTIGATION OF VAPOR INTRUSION.....</b>	<b>61</b>
6.1	Common Vapor Intrusion Scenarios.....	61
6.2	Planning and Scoping.....	63
6.2.1	Vapor Intrusion Inclusion Zones.....	67
6.2.2	Prioritizing Investigations with Multiple Buildings.....	69
6.2.3	Planning for Community Involvement.....	71
6.3	Characterize the Vapor Intrusion Pathway .....	71
6.3.1	Characterize Nature and Extent of Subsurface Vapor Sources.....	72
6.3.2	Characterize Vapor Migration in the Vadose Zone .....	75
6.3.3	Assess Building Susceptibility to Soil Gas Entry.....	78
6.3.4	Evaluate Presence and Concentration of Subsurface Contaminants in Indoor Air.....	80
6.3.5	Identify and Evaluate Contributions from Indoor and Ambient Air Sources.	81
6.3.6	Select, Prioritize, and Sequence Investigation Objectives.....	86
6.4	General Principles and Recommendations for Sampling .....	87
6.4.1	Indoor Air Sampling.....	88
6.4.2	Outdoor Air Sampling.....	98
6.4.3	Sub-slab Soil Gas Sampling.....	99
6.4.4	Soil Gas Sampling.....	103
6.4.5	Groundwater Sampling.....	104

6.4.6	Planning for Building and Property Access.....	105
6.5	Overview of Risk-Based Screening.....	105
6.5.1	Objectives of Screening.....	105
6.5.2	Scope and Basis for Health-based, Vapor Intrusion Screening Levels.....	106
6.5.3	Recommended Attenuation Factors for Health-based Screening.....	108
6.5.4	Comparing Sample Concentrations to Health-based Screening Levels....	111
6.5.5	Planning for Communication of Sampling Results.....	112
6.6	General Principles and Recommendations for Mathematical Modeling .....	113
<b>7.0</b>	<b>RISK ASSESSMENT AND MANAGEMENT FRAMEWORK.....</b>	<b>117</b>
7.1	Collect Site-specific Lines of Evidence.....	117
7.2	Weigh and Assess Concordance Among the Lines of Evidence.....	120
7.3	Evaluate Whether the Vapor Intrusion Pathway is Complete or Incomplete.....	122
7.4	Conduct and Interpret Human Health Risk Assessment.....	124
7.4.1	Risk Management Benchmarks.....	127
7.4.2	Accounting for Background Contributions .....	128
7.4.3	Occupational Exposure Limits .....	128
7.5	Concentration Levels Indicating Potential Need for Prompt Response Action.....	129
7.5.1	Potential Explosion Hazards.....	129
7.5.2	Considering Short-term and Acute Exposures.....	129
7.6	Risk-based Cleanup Levels .....	131
7.7	Options for Response Action .....	132
7.8	Pre-emptive Mitigation/Early Action.....	134
7.8.1	Rationale .....	135
7.8.2	General Decision Framework.....	136
7.8.3	Some General Scenarios Where Pre-emptive Mitigation May be Warranted.....	137
7.8.4	Additional Considerations.....	141
<b>8.0</b>	<b>BUILDING MITIGATION AND SUBSURFACE REMEDIATION.....</b>	<b>143</b>
8.1	Subsurface Remediation for Vapor Source Control.....	143
8.2	Building Mitigation for Vapor Intrusion.....	144
8.2.1	Prompt Response Options for Existing Buildings.....	144
8.2.2	Active Depressurization Technologies for Existing Buildings.....	147
8.2.3	Approaches and Considerations for New Buildings .....	150
8.2.4	Owner/Occupant Preferences and Building Access.....	151

8.3	Operation and Maintenance of Vapor Intrusion Mitigation Systems.....	151
8.4	Monitoring of Vapor Intrusion Mitigation Systems .....	153
8.5	Documentation of Engineered Exposure Controls for Vapor Intrusion Mitigation...	156
8.6	Use of Institutional Controls.....	157
8.6.1	Evaluating ICs in the Overall Context of Response Selection .....	158
8.6.2	Common Considerations and Scenarios Involving ICs .....	159
8.6.3	Selecting the Right Instrument(s).....	163
8.6.4	Long-term Stewardship .....	165
8.6.5	Community Involvement and ICs .....	166
8.7	Termination/Exit Strategy.....	167
8.7.1	Termination of Subsurface Remediation Activities.....	167
8.7.2	Termination of Building Mitigation .....	168
8.7.3	Termination of ICs.....	170
8.7.4	Termination of Monitoring.....	170
<b>9.0</b>	<b>PLANNING FOR COMMUNITY INVOLVEMENT.....</b>	<b>175</b>
9.1	Developing a Community Involvement or Public Participation Plan.....	177
9.2	Communication Strategies and Conducting Community Outreach .....	179
9.3	Addressing Building Access for Sampling and Mitigation.....	182
9.4	Communication of Indoor Sampling Efforts and Results .....	183
9.5	Transmitting Messages Regarding Mitigation Systems.....	185
9.6	Addressing Community Involvement at Legacy Sites.....	186
9.7	Property Value Concerns for Current and Prospective Property Owners.....	187
9.8	Additional Community Involvement Resources.....	187
<b>10.0</b>	<b>GLOSSARY .....</b>	<b>189</b>
<b>11.0</b>	<b>CITATIONS AND REFERENCES .....</b>	<b>202</b>
	<b>APPENDIX A Recommended Subsurface-to-Indoor Air Attenuation Factors .....</b>	<b>A-1</b>
	<b>APPENDIX B Data Quality Assurance Considerations.....</b>	<b>B-1</b>
	<b>APPENDIX C Calculating Vapor Source Concentration from Groundwater Data.....</b>	<b>C-1</b>

---

## LIST OF FIGURES

- Figure 2-1 Illustration of Key Elements of the Conceptual Model of Soil Vapor Intrusion
- Figure 2-2 Illustration of Potential Openings in Various Building Types
- Figure 2-3 Some Factors That Affect Vapor Intrusion
- Figure 3-1 Overview of Recommended Framework for Vapor Intrusion Assessment and Response Action
- Figure 6-1 Overview of Planning, Scoping, and Conducting Vapor Intrusion Investigations
- Figure 7-1 Sample Depiction of Subsurface Vapor Source and Data to Support Pre-emptive Mitigation/Early Action for Multiple Buildings, Each with Limited Data
- Figure 7-2 Sample Depiction of Subsurface Vapor Source and Data to Support Pre-emptive Mitigation/Early Action for Multiple Buildings, Some with Only Limited or No Data
- Figure 8-1 Illustration of Sub-slab Depressurization (SSD) System
- Figure 8-2 Illustration of Drain-tile Depressurization (DTD) System
- Figure 8-3 Illustration of Block-wall Depressurization (BWD) System
- Figure 8-4 Illustration of Sub-membrane Depressurization (SMD) System

## LIST OF TABLES

- Table 1-1 Directory to Updates in This Technical Guide Addressing Recommendations of EPA Office of Inspector General (EPA 2009)
- Table 1-2 Directory to Additional Updates in This Technical Guide Publicly Identified by OSWER (EPA 2010A)
- Table 1-3 Vapor Intrusion Topics Receiving Substantive Public Comment
- Table 6-1 Recommended Vapor Attenuation Factors for Risk-based Screening of the Vapor Intrusion Pathway
- Table 7-1 Matrix of Options to Respond to Human Health Risk Posed by the Vapor Intrusion Pathway
- Table 8-1 Vapor Intrusion Mitigation Quick Guide for Existing Buildings

## **LIST OF APPENDICES**

- Appendix A Recommended Subsurface-to-Indoor Air Attenuation Factors
- Appendix B Data Quality Assurance Considerations
- Appendix C Calculating Vapor Source Concentration from Groundwater Sampling Data



---

## ACRONYMS AND ABBREVIATIONS

ACH	air changes per hour (air exchanges per hour)
ADT	active depressurization technology
AER	air exchange rate
ANSI	American National Standards Institute
ASQ	American Society for Quality
ASTM	American Society for Testing and Materials
ASTSWMO	Association of State and Territorial Solid Waste Management Officials
ATSDR	Agency for Toxic Substances and Disease Registry
BTEX	benzene, toluene, ethylbenzene, xylenes
BWD	block-wall depressurization
CalEPA	California Environmental Protection Agency
CASRN	Chemical Abstracts Service Registry Number
CEI	Community Engagement Initiative
CERCLA	Comprehensive Environmental Response, Compensation, and Liability Act
CFR	Code of Federal Regulations
CHC	chlorinated hydrocarbon
CIC	Community Involvement Coordinator
CIO	Chief Information Officer
CIP	community involvement plan
CMS	corrective measures study
CSM	conceptual site model
DCE	dichloroethylene, or equivalently dichloroethene
DNAPL	dense non-aqueous-phase liquid
DoD	U.S. Department of Defense
DoN	U.S. Department of Navy
DQO	data quality objective
DTD	drain-tile depressurization
EI	environmental indicator
EPA	U.S. Environmental Protection Agency
ERT	Environmental Response Team
FR	Federal Register
FS	feasibility study

---

FYR	five-year review
HI	Hazard Index
HQ	Hazard Quotient
HVAC	heating, ventilation and air conditioning
IC	institutional control
ICIAP	Institutional Controls Implementation and Assurance Plan
IDLH	immediately dangerous to life or health
ITRC	Interstate Technology and Regulatory Council
LCR	lifetime cancer risk
LEL	lower explosive limit
LEP	limited English proficiency
LNAPL	light non-aqueous-phase liquid
LTS	long-term stewardship
MADEP	Massachusetts Department of Environmental Protection
NAPL	non-aqueous-phase liquid
NAS	National Academy of Sciences
NCP	National Oil and Hazardous Substances Pollution Contingency Plan
NFA	No Further Action
NIST	National Institute of Standards and Technology
NPL	National Priorities List
NRC	National Research Council
NIOSH	National Institute for Occupational Safety and Health
NYSDOH	New York State Department of Health
O&M	operation and maintenance
OIG	Office of the Inspector General
OSC	on-scene coordinator
OSHA	Occupational Safety and Health Administration
OSWER	Office of Solid Waste and Emergency Response
OUST	Office of Underground Storage Tanks
PAH	polycyclic aromatic hydrocarbon
PCB	polychlorinated biphenyl
PCE	tetrachloroethylene, or equivalently tetrachloroethene
PEM	preemptive mitigation
PID	photoionization detector

P.E.	Professional Engineer
ppbv	parts per billion by volume
PRP	potentially responsible party
QAPP	quality assurance project plan
QMP	quality management plan
RCRA	Resource Conservation and Recovery Act
RfC	inhalation reference concentration
RFI	RCRA facility investigation
RI	remedial investigation
RME	reasonable maximum exposure
ROD	Record of Decision
RPM	remedial project manager
SMD	sub-membrane depressurization
SSD	sub-slab depressurization
TAGA	trace atmospheric gas analyzer
TCE	trichloroethylene, or equivalently trichloroethene
UFP-QAPP	Uniform Federal Policy for Quality Assurance Project Plans
UECA	Uniform Environmental Covenants Act
USPS	U.S. Postal Service
UST	underground storage tank
UU/UE	unlimited use/unrestricted exposure
VI	vapor intrusion
VISL	vapor intrusion screening level
VOC	volatile organic compound

---

## EXECUTIVE SUMMARY

### Definition and Description of Vapor Intrusion

Vapor intrusion is the general term given to migration of hazardous vapors from any subsurface vapor source, such as contaminated soil or groundwater, through the soil and into an overlying building or structure. These vapors can enter buildings through cracks in `basements and foundations, as well as through conduits and other openings in the building envelope. Vapors can also enter structures that are not intended for human occupancy (e.g., sewers, drain lines, access vaults, storage sheds, pump houses) through cracks and other openings.

All types of buildings, regardless of foundation type (e.g., basement, crawl space, slab-on-grade), have openings that render them potentially vulnerable to vapor intrusion. Buildings subject to vapor intrusion include, but are not limited to, residential buildings (e.g., detached single-family homes, trailer or 'mobile' homes, multi-unit apartments and condominiums), commercial workplaces (e.g., office buildings, retail establishments), educational and recreational buildings (e.g., schools and gyms), and industrial facilities (e.g., manufacturing plants).

Vapor intrusion is a potential human exposure pathway -- a way that people may come into contact with hazardous vapors while performing their day-to-day indoor activities. For purposes of this Technical Guide, the vapor intrusion pathway is referred to as "complete" for a specific building or collection of buildings when the following five conditions are met under current conditions:

- 1) A subsurface source of vapor-forming chemicals is present (e.g., in the soil or in groundwater) underneath or near the building(s) (see Sections 2.1, 5.3, 6.2.1, and 6.3.1);
- 2) Vapors form and have a route along which to migrate (be transported) toward the building (see Sections 2.2 and 6.3.2);
- 3) The building(s) is(are) susceptible to soil gas entry, which means openings exist for the vapors to enter the building and driving 'forces' (e.g., air pressure differences between the building and the subsurface environment) exist to draw the vapors from the subsurface through the openings into the building(s) (see Sections 2.3 and 6.3.3);
- 4) One or more vapor-forming chemicals comprising the subsurface vapor source(s) is(are) present in the indoor environment (see Sections 6.3.4 and 6.4.1); and
- 5) The building(s)<sup>1</sup> is(are) occupied by one or more individuals when the vapor-forming chemical(s) is(are) present indoors.

---

<sup>1</sup> For purposes of this Technical Guide and its recommendations for evaluating human health risk posed by vapor-forming chemicals, "building" refers to a structure that is intended for occupancy and use by humans. This would include, for instance, homes, offices, stores, commercial and industrial buildings, etc., but would not normally include sheds, carports, pump houses, or other structures that are not intended for human occupancy.

A complete vapor intrusion pathway indicates that there is an opportunity for human exposure, which warrants further analysis (see Section 7.4) to determine whether there is a basis for undertaking a response action(s) (see Section 7.7). Depending upon building- and site-specific circumstances, concentrations of chemical vapors indoors arising from a complete vapor intrusion pathway may threaten the health of building occupants (e.g., residents, workers, etc.), which may warrant a response action(s).

On the other hand and for purposes of this Technical Guide, if one (or more) of the five foregoing conditions is currently absent and is reasonably expected to be absent in the future (e.g., vapor migration is significantly and persistently impeded by natural geologic, hydrologic, or biochemical (e.g., biodegradation) processes and conditions), the vapor intrusion pathway is referred to as “incomplete.” EPA recommends that any determination that the vapor intrusion pathway is incomplete be supported by site-specific evidence to demonstrate that the nature and extent of vapor-forming chemical contamination in the subsurface has been well characterized (Section 6.3.1) and the types of vapor sources and the conditions of the vadose zone and surrounding infrastructure do not present opportunities for unattenuated or enhanced transport of vapors (Sections 5.4 and 6.5.2) toward and into any building (see Section 7.3 for further discussion). When the vapor intrusion pathway is determined to be incomplete, then vapor intrusion mitigation is not generally warranted.

EPA recommends that site managers also evaluate whether subsurface vapor sources that remain have the potential to pose unacceptable human health risks due to vapor intrusion in the future<sup>2</sup> if site conditions were to change. The vapor intrusion pathway is referred to as ‘potentially complete’ for a building when:

- a subsurface source of vapor-forming chemicals is present underneath or near an existing building or a building that is reasonably expected to be constructed in the future;
- vapors can form from this source(s) and have a route along which to migrate (be transported) toward the building; and
- three additional conditions are reasonably expected to all be met in the future, which may not all be met currently; i.e.,
  - the building is susceptible to soil gas entry, which means openings exist for the vapors to enter the building and driving forces exist to draw the vapors from the subsurface through the openings into the building;
  - one or more vapor-forming chemicals comprising the subsurface vapor source(s) is (or will be) present in the indoor environment; and
  - the building is or will be occupied by one or more individuals when the vapor-forming chemical(s) is (or are) present indoors.

---

<sup>2</sup> “Both current and reasonably likely future risks need to be considered in order to demonstrate that a site does not present an unacceptable risk to human health and the environment.” (EPA 1991a).

In addition to their toxicity threats, methane and certain other vapor-forming chemicals can also pose explosion hazards depending upon structure-, building-, and site-specific circumstances. Explosion hazards may pose an imminent and substantial danger to human health and public welfare.

### Technical Guide Development and Recommended Uses

To help assess the subsurface vapor intrusion pathway, the Office of Solid Waste and Emergency Response (OSWER) released in November 2002 for comment EPA's *Draft Guidance for Evaluating the Vapor Intrusion to Indoor Air Pathway from Groundwater and Soils* ("Draft VI Guidance"). Since the Draft VI Guidance was released, EPA's knowledge of and experience with assessment and mitigation of the vapor intrusion pathway has increased considerably, leading to an improved understanding of and enhanced approaches for evaluating and managing vapor intrusion. In addition, EPA received hundreds of comments from the public since 2002 on the Draft VI Guidance, on a public review draft issued in April 2013, and on emerging practices and science considerations.

This Technical Guide presents current technical recommendations of the EPA based on our current understanding of vapor intrusion into indoor air from subsurface vapor sources. One of its main purposes is to promote national consistency in assessing the vapor intrusion pathway.<sup>3</sup> At the same time, it provides a flexible science-based approach to assessment that accommodates the different circumstances (e.g., stage of the cleanup process) in which vapor intrusion is first considered at a site and differences among pertinent EPA programs. This Technical Guide is intended for use at any site (and any building or structure on a site) being evaluated by EPA pursuant to the Comprehensive Environmental Response, Compensation, and Liability Act (CERCLA) or the corrective action provisions of the Resource Conservation and Recovery Act (RCRA), EPA's brownfield grantees, or state agencies acting pursuant to CERCLA or an authorized RCRA corrective action program where vapor intrusion may be of potential concern. This document and the accompanying *Technical Guide For Addressing Petroleum Vapor Intrusion At Leaking Underground Storage Tank Sites* (EPA 2015b)<sup>4</sup> supersede and replace the Draft VI Guidance.

Although this Technical Guide is intended for use at any site subject to federal statutes, regulations, and rules, it is not intended to alter existing requirements, guidance, or practices among OSWER's programs about development, selection, or documentation of final remediation<sup>5</sup> plans (addressing subsurface vapor sources, for example).

---

<sup>3</sup> If EPA staff wish to consider using any specific guidance that is not explicitly recommended in this Technical Guide, they should consult with Headquarters.

<sup>4</sup> For petroleum hydrocarbons that arise from petroleum that has been released from Subtitle I UST systems, EPA has developed a companion to this Technical Guide (*Technical Guide For Addressing Petroleum Vapor Intrusion At Leaking Underground Storage Tank Sites* (EPA 2015b)), which provides information and guidance about how EPA recommends vapor intrusion be assessed for petroleum hydrocarbons in these settings.

<sup>5</sup> For purposes of this Technical Guide, "remediation" is intended to apply to interim and final cleanups, whether conducted pursuant to RCRA corrective action, the CERCLA removal or remedial programs, or using EPA brownfield grant funds with oversight by state and tribal response programs. In addition to permanent remedies for subsurface vapor sources, site remediation may also entail implementation of institutional controls and construction and operation of engineered systems for exposure control.

## Document Content and Key Recommendations

This document is comprised of eleven sections and three appendices, including a list of acronyms, which precedes this summary, and a glossary of terms in Section 10. Section 3 provides an overview of the entire Technical Guide and can be further summarized as follows:

- Broadly speaking, two general levels of vapor intrusion assessments can be distinguished:
  - 1) A preliminary analysis, which utilizes available and readily ascertainable information to develop an *initial* understanding of the potential for human health risks to be posed by vapor intrusion, which would typically be performed as part of an initial site assessment (Section 5).
  - 2) A detailed investigation (Section 6), which is generally recommended when the preliminary analysis (e.g., Section 5.3) indicates that subsurface contamination with vapor-forming chemicals may be present underlying or near buildings. A detailed investigation of the vapor intrusion pathway is typically performed as part of the site investigation stage.

The approach for assessing vapor intrusion will vary from site to site, because each site will differ in the available data when vapor intrusion is being evaluated. This Technical Guide, therefore, recommends a framework for planning and conducting vapor intrusion investigations, rather than a prescriptive step-by-step approach to be applied at every site.

- Response actions to address vapor intrusion when it poses unacceptable human health risks (Sections 7.7 and 8) typically entail a combination of:
  - remediation to reduce or eliminate subsurface vapor sources (Section 8.1);
  - engineered exposure controls for specific buildings to reduce vapor intrusion or reduce concentrations of vapor-forming chemicals that have already entered the building (Section 8.2);
  - monitoring to assess and verify the performance and effectiveness of the remediation systems and engineered exposure controls (Section 8.4); and
  - institutional controls (ICs) to restrict land use and/or to alert parties (e.g., prospective developers, owners, and municipalities) of the presence of subsurface sources of vapor-forming chemicals and to foster operation, maintenance, and monitoring of the remediation systems and engineered exposure controls (Section 8.6).

Additional response actions to avoid or reduce human exposure may also warrant consideration in circumstances where “early” or prompt response action is appropriate to address indoor air exposure conditions or a potential for explosion hazards.

Additional key recommendations and policies comprising this document include the following:

Planning, Scoping and Conducting Investigations (see Sections 5.4 and 6.2 for further information)

- Consider site and building access agreements, equipment security, and locations of underground utilities and piping, such as storm and sewer lines within buildings, when planning vapor intrusion investigations (Section 6.2).
- Develop an initial conceptual site model, use this model to guide planning and scoping of the investigation, and update this model as additional information and insights are generated (Sections 5.4, 7.1, and 7.2).
- Generally limit chemical analyses to those vapor-forming chemicals known or reasonably expected to be present in the subsurface environment.
- Consider a “worst first” approach to prioritize buildings for investigation at sites where numerous buildings are potentially subject to vapor intrusion (Section 6.2.2).
- To the extent practical, plan and implement investigations within buildings and on individual properties with the goal of limiting return visits, which can cause disruption and inconvenience for building occupants and owners (Section 6.2).
- Generally assess the vapor intrusion pathway by collecting, weighing, and evaluating multiple lines of evidence (Sections 6.3, 7.1, and 7.2).
- Utilize 100 feet to define an initial lateral inclusion zone for vapor intrusion assessment (i.e., for identifying buildings that are ‘near’ a subsurface vapor source and generally warrant assessment) for purposes of a preliminary analysis). Investigate soil vapor migration distance (e.g., define inclusion zone(s) for assessing vapor intrusion in specific buildings) on a site-specific basis. That is, distances larger or smaller than 100 feet (i.e., beyond or within an initial 100-foot inclusion zone) may need to be considered when developing objectives for detailed vapor intrusion investigations and interpreting the resulting data (Section 6.2.1).
- To support evaluations of sources of indoor air concentrations, identify in individual buildings known or suspected indoor sources of the vapor-forming chemicals also found in the subsurface and characterize ambient air quality in the site vicinity for these same chemicals (Sections 6.3.5 and 6.4).
- Select sampling and analytical methods that are capable of obtaining reliable analytical detections of concentrations less than project-appropriate, risk-based screening levels (e.g., vapor intrusion screening levels, or VISLs).
- When groundwater is a subsurface source of vapors, collect groundwater samples from wells screened across the top of the water table to characterize the source strength for vapor intrusion (Sections 6.3.1 and 6.4.5).
- Collect indoor air samples to characterize exposure levels in indoor air, account for seasonal variations in climate and the habits of building occupants, and ensure that



related risk management decisions are based upon a consideration of a reasonable maximum vapor intrusion condition for a given building (Sections 6.3.4 and 6.4.1).

- When sampling indoor air,
  - employ time-integrated sampling methods (e.g., evacuated canisters, sorbent-based sampling devices). Indoor air concentrations can be temporally variable and time-integrated exposure estimates over appropriate exposure durations (e.g., chronic typically; less-than-chronic in some cases) are generally most useful for exposure and human health risk assessment (Sections 6.4.1 and 7.4);
  - remove potential indoor sources<sup>6</sup> of vapor-forming chemicals from the building to strive to ensure that the concentrations measured in the indoor air samples are attributable to the vapor intrusion pathway (Sections 6.3.5 and 6.4.1); and
  - measure the pressure difference between the indoors and the subsurface, which provides a complementary line of evidence to support data evaluation and interpretation (Section 6.4.1) and is a more direct means of assessing building under-pressurization than is monitoring weather/climate factors (e.g., air temperature, wind speed).
- Mathematical modeling of vapor intrusion is most appropriately used in conjunction with other lines of evidence (Section 6.6).
- Confirm the reliability of modeling results, especially when limited site-specific data are available as inputs (Section 6.6).
- Collect and evaluate appropriate site-specific information to demonstrate that the property fulfills the conditions and assumptions of the generic conceptual model underlying the vapor intrusion screening levels (Section 6.5.2).

#### Data Evaluation and Decision-making

- Assess (and seek) concordance among the lines of evidence to more confidently support decision-making (Sections 7.1, 7.2, and 7.3).<sup>7</sup> Multiple lines of evidence are generally recommended for supporting conclusions, such as the following:
  - The subsurface vapor source(s) at a specific site has the potential to pose an unacceptable vapor intrusion exposure under current or reasonably expected future conditions, due to its vapor strength (Section 6.5) and proximity relative to one or more existing buildings or a building that may be constructed in the future (Section 6.2.1).

---

<sup>6</sup> As mentioned in Section 6.3.5, indoor sources can sometimes be identified and located using portable instruments.

<sup>7</sup> Confidence in the assessment and risk management decisions is expected to be higher when multiple independent lines of evidence come together to provide mutually supporting evidence for a common understanding of the site conditions/scenarios and the potential for vapor intrusion (EPA 2010b).

- The vapor intrusion pathway is complete for one or more buildings under current or reasonably expected future conditions (Section 7.3).
- The vapor intrusion pathway is incomplete for one or more buildings near a subsurface source of vapor-forming chemicals (Section 7.3), due to
  - inadequate source strength (i.e., chemicals comprising subsurface contamination and/or their potential vapor concentrations cannot pose an unacceptable human health risk via the vapor intrusion pathway) (Section 6.5); or
  - geologic, hydrologic, and/or biochemical (e.g., biodegradation) processes that provide substantial and persistent attenuation of vapors extending laterally over large distances relative to the footprint of the building(s) and the extent of the vapor source (Section 6.3.2).
- Indoor air concentrations attributable to vapor intrusion pose (or, alternatively, are unlikely to pose) an unacceptable human health risk in one or more existing buildings under current or reasonably expected future conditions, based upon currently available information about a chemical's toxicity (Section 7.4).
- Indoor air concentrations measured in one or more buildings can (or alternatively, cannot) be reasonably attributed to indoor or ambient air sources (i.e., background – see Glossary) (Sections 6.3.5 and 7.4.2).

Multiple lines of evidence are particularly important for supporting “no-further-action” decisions regarding the vapor intrusion pathway (e.g., pathway incomplete determinations) to reduce the chance of reaching a false-negative conclusion (i.e., concluding vapor intrusion does not pose unacceptable human health risk, when it actually poses an unacceptable human health risk). Collecting and weighing multiple lines of evidence can also reduce the chance of reaching a false-positive conclusion (i.e., concluding vapor intrusion poses unacceptable human health risk, when it does not). On the other hand, parties may implement engineered exposure controls for vapor intrusion, even though only limited lines of evidence or measurements may be available to characterize the overall vapor intrusion pathway.

- Consider reasonably expected future conditions, in addition to current conditions, when reaching conclusions about the vapor intrusion pathway (Sections 3.2 and 7.3). For example, EPA recommends that vapor intrusion be evaluated for reasonably expected future land use conditions, including new building construction and new uses and occupants for uninhabited buildings.
- Identify any conditions that warrant prompt action (Section 7.5) and respond, consistent with applicable statutes and regulations and considering EPA guidance, with actions that eliminate, avoid, reduce or otherwise address the human health risk posed by vapor intrusion (Sections 7.7 and 8.2):
  - Explosive conditions and threats that warrant prompt action (Section 7.5.1) are reasonably suspected to exist when measured concentrations of vapors in the building, utility conduits, sumps, subsurface drains, or other structure directly

- connected to the building exceed one-tenth (10%) of the lower explosive limit (LEL).<sup>8</sup> EPA recommends evacuation of buildings with potential explosion and fire hazards, along with notification to the local fire department about the situation.
- Conditions posing health concerns that warrant prompt action are reasonably suspected to exist when estimated exposure concentrations of vapors in the building exceed health-protective concentrations for short-term or acute exposure (Section 7.5.2).
  - When making decisions pertaining to the assessment of vapor intrusion at nonresidential buildings, consider the characteristics of the populations potentially exposed to vapor-forming chemicals in the indoor air, the relative contributions of vapors from background (including anthropogenic background), and any existing or planned engineering or institutional controls for the building, in addition to the potential for vapor intrusion (Sections 4, 6.3.5, 6.4.1 and 7.4.2).
  - When evaluating environmental sampling results to assess the vapor intrusion pathway, first determine that the samples were collected appropriately (Sections 5.5 and 6.4).
  - Before conducting risk-based screening, verify that the site fulfills the conditions and assumptions of the generic conceptual model underlying the VISLs (Section 6.5.2).
  - Compare groundwater concentrations to the VISLs (Section 6.5) for groundwater to estimate the boundaries of the plume, when contaminated groundwater is the subsurface vapor source for vapor intrusion (Section 6.2.1).
  - Generally support the decision to collect indoor air data (Section 6.4.1) by lines of site- or building-specific evidence that demonstrate vapor intrusion has the potential to pose a significant human exposure [e.g., data on strength and proximity of subsurface vapor source(s) (Sections 6.2.1, 6.3.1, and 6.5), or preferential vapor migration in the vadose zone or into buildings (Sections 5.4, 6.3.2, and 6.3.3)].
  - Consider variability in laboratory analyses when evaluating sampling data.
  - Generally conduct a human health risk assessment to determine whether the potential human health risks posed to building occupants are within or exceed acceptable levels consistent with applicable statutes and considering EPA guidance (Section 7.4).
  - Consider the potential for adverse non-cancer health effects from short-duration exposures (i.e., acute, short-term, or subchronic exposure durations), as well as longer term exposure (i.e., chronic exposure) conditions, and select toxicity values considering OSWER's preferred hierarchy of sources (EPA 2003) (Sections 7.4 and 7.5.2).

---

<sup>8</sup> The Occupational Safety and Health Administration of the U.S. Department of Labor (OSHA) considers concentrations in excess of one-tenth of the LEL to be a hazardous atmosphere in confined spaces [29 CFR 1910.146(b)]. The National Institute for Occupational Safety and Health (NIOSH) has designated such concentrations as immediately dangerous to life or health (IDLH).

- Consider collecting multiple rounds of indoor air samples,<sup>9</sup> using time-integrated measurements (Section 6.4.1) to estimate exposure concentrations appropriate for the exposure (occupancy) scenario being evaluated (e.g., residential versus commercial), when the risk assessment for an existing building would support a conclusion that the human health risks are acceptable (Section 7.4).<sup>10</sup>
- In the risk characterization of the human health risk assessment, discuss ‘background’ contributions to indoor air exposure and associated human health risks (Section 7.4.2). (For purposes of this Guide, ‘background’ refers to a vapor-forming chemical(s) or location(s) that is(are) not influenced by the releases from a site – see Glossary). Information on ‘background’ contributions of site-related, vapor-forming chemicals in indoor air is important to risk managers because generally EPA does not clean up to concentrations below natural or anthropogenic background levels<sup>11</sup> (EPA 2002e).
- If data are available, distinguish the contribution of ‘background’ to total exposure concentration(s). With such information, EPA can help advise affected individuals about the environmental and human health risks they face. Other parties, including building owners and operators, may help with risk communication.
- If background vapor sources (see Glossary) are found to be primarily responsible for indoor air concentrations (see Section 6.3.5), then response actions for vapor intrusion would generally not be warranted for current conditions.

### Engineered Exposure Controls and Building Mitigation

- When vapor intrusion has been determined to pose unacceptable human health risks,
  - Aim to achieve a permanent remedy by eliminating or substantially reducing the level(s) of vapor-forming chemical(s) in the subsurface source medium (e.g., groundwater, subsurface soil, sewer lines) (Sections 7.7 and 8.1); and
  - In cases where subsurface vapor sources cannot be remediated quickly, implement engineered exposure controls to reduce or eliminate vapor intrusion in buildings (i.e., “mitigate” vapor intrusion) or reduce indoor air exposure levels (Sections 7.7 and 8.2).

---

<sup>9</sup> Because weather conditions and building operations can lead to time-variable contributions from vapor intrusion and ambient air infiltration, indoor air concentrations of vapor-forming chemicals can be expected to vary over time (see, for example, Section 2.6). An individual sample (or single round of sampling) would be insufficient to characterize seasonal variability, or variability at any other time scale.

<sup>10</sup> EPA recommends basing the decision about whether to undertake response action for vapor intrusion (i.e., a component of risk management; see Section 7.4) on a consideration of a reasonable maximum exposure (e.g., EPA 1989, 1991a), which is a semi-quantitative term, referring to the lower portion of the high end of the exposure distribution (see Glossary).

<sup>11</sup> With respect to vapor intrusion mitigation (see Sections 3.5 and 8.2), some options for reducing indoor air exposure levels (e.g., ventilation, indoor air treatment) unavoidably act on background concentrations arising from indoor or outdoor sources, as well as vapor concentrations arising from vapor intrusion. Most options for interrupting the vapor intrusion pathway (e.g., active depressurization technologies – see Section 8.2) unavoidably interrupt the intrusion of naturally occurring radon also. It should also be noted that some EPA regulations (e.g., indoor radon standards under 40 CFR 192.12) are inclusive of background.

- When developing monitoring programs to assess effectiveness of building mitigation, consider the degree of human health risk or hazard being mitigated, the building use, the technology used to mitigate vapor intrusion, and coordination with site remediation efforts.
- Establish cleanup levels and criteria for terminating engineered exposure controls and other building mitigation methods, institutional controls, and remediation systems for subsurface vapor sources (Sections 7.6 and 8.7).

#### Document Activities and Decisions

- Document objectives and methods of vapor intrusion investigations, preferably in a vapor intrusion work plan (Section 6.2).
- Base decisions upon data and information in the administrative record.
- Base decisions to undertake response actions on lines of site- or building-specific evidence (e.g., characterization of subsurface vapor source(s) strength and proximity to building(s); building conditions) that demonstrate that vapor intrusion has the potential to pose an unacceptable human health risk (Section 7).
- Document, consistent with statutory requirements and considering prevailing guidance for the respective land restoration program (e.g., CERCLA, RCRA corrective action, brownfields, etc.), any and all decisions pertaining to vapor intrusion, including decisions to undertake (or not to undertake) investigation or mitigation of specific buildings at a contaminated site.
- Prepare and publish system manuals to document building mitigation and remediation systems (Section 8.5).
- Prepare and implement operations and maintenance manuals and practices to foster continued effective operation and performance of engineered exposure controls and remediation systems for subsurface vapor sources (Section 8.5).
- Document monitoring programs that assess the performance and effectiveness of remediation and mitigation systems.

#### Community Outreach and Involvement (Section 9)

- Develop or refine a community involvement or public participation plan while planning a vapor intrusion investigation and implement this plan throughout the assessment, remediation, and mitigation phases.
- Conduct building-by-building contact and communication as means of educating the community and obtaining access needed to assess, mitigate, and monitor the vapor intrusion pathway. Personal contact is further recommended to establish a good working relationship with each building owner or occupant and to build trust.

- Generally provide validated results and interpretations (e.g., chemicals of concern, associated risk assessment implications) to property owners and occupants in a timely manner (e.g., within approximately 30 days of receiving these results).
- Provide adequate opportunities for public participation (including potentially affected landowners and communities) when considering appropriate use of ICs.

The science and technology to assess and mitigate vapor intrusion have evolved significantly over the past decade. EPA will continue to monitor these evolving developments and will update these recommendations in the future, if and as appropriate.

## 1.0 INTRODUCTION

This technical guide was prepared by the U.S. Environmental Protection Agency (EPA) through the cooperative efforts of a team of EPA Headquarters and Regional staff, known as the Vapor Intrusion Intra-Agency Workgroup (Workgroup). Drafts of this document were subjected to a comprehensive, consultative peer-input process in 2012, as described in EPA's *Peer Review Handbook* (EPA-SPC 2006), which included comments and other contributions from Workgroup members representing several EPA offices and the EPA's Vapor Intrusion Forum.<sup>12</sup> Public comments submitted from 2002 through 2013 and recommendations of the Office of Inspector General (OIG) were also considered in developing this document.

This document comprises EPA's 'final' vapor intrusion technical guide<sup>13</sup> and is referred to herein as "this Technical Guide." It describes a recommended framework for assessing vapor intrusion that relies upon collecting and evaluating multiple lines of evidence to support risk management decisions. It also provides technical recommendations about monitoring and terminating building mitigation systems.

This Technical Guide relied upon a large body of scientific information found in the peer-reviewed literature. Additionally, EPA developed three technical support documents that were externally peer reviewed (EPA 2011a, 2012a, 2012b). This approach is consistent with EPA's peer review handbook and policy (EPA-SPC 2006). Peer-reviewed literature, peer-reviewed technical reports, existing and relevant EPA guidance (e.g., for conducting human health risk assessment; for planning and conducting investigations of environmental contamination), and other pertinent information that support development or implementation of this Technical Guide are cited within.

This introductory section: defines the term "vapor intrusion"; summarizes EPA's statutory authorities to protect human health from vapor intrusion; summarizes the intended uses of this Technical Guide, including its applicability to petroleum hydrocarbons and other potentially biodegradable chemicals and to nonresidential buildings; identifies key technical resources that facilitate consideration of its recommendations; provides a concise historical accounting of its development; describes how the public was involved in its development; and provides an overview of its organization.

### 1.1 Definition of Vapor Intrusion

Certain chemicals that are released into the subsurface<sup>14</sup> as liquids or solids may form hazardous vapors that migrate or are transported through the vadose zone<sup>15</sup> and eventually

---

<sup>12</sup> The EPA Vapor Intrusion Forum is an intra-Agency group engaged in sharing information, technical resources, and perspectives pertaining to vapor intrusion assessment and mitigation.

<sup>13</sup> This document is intended to fulfill EPA's commitment to the OIG to issue "updated, revised, and finalized" vapor intrusion guidance (EPA 2009a, Appendix B; EPA 2010b).

<sup>14</sup> For purposes of this Technical Guide, the phrases 'released into the subsurface' and 'release to the subsurface' are intended to encompass any and all mechanisms by which chemical contamination arises in the subsurface, including, for example, spills and releases above the ground surface that result in subsurface (e.g., soil and groundwater) contamination.

enter buildings as a component of a gas<sup>16</sup> by migrating (being transported) through cracks, seams, interstices, and gaps in basement floors, walls, or foundations (“adventitious openings”), through intentional openings (e.g., perforations due to utility conduits, sump pits), and/or within conduits (e.g., drain and sewer lines). Vapor intrusion is the general term given to migration of hazardous vapors from any subsurface contaminant source, such as contaminated soil or groundwater or contaminated conduit(s), into an overlying building or unoccupied structure via any opening or conduit.

Recognition of soil vapor intrusion to buildings and other enclosed spaces occurred in the 1980s with concerns over radon intrusion.<sup>17</sup> Subsequently, there was an increasing awareness that anthropogenic chemicals (e.g., petroleum hydrocarbons and chlorinated solvents) in soil and ground water could also pose threats to indoor air quality via the vapor intrusion pathway (Little et al. 1992; Moseley and Meyer 1992).

Vapor intrusion can occur in a broad range of land use settings, including residential, commercial, and industrial, and affect buildings with virtually any foundation type (e.g., basement, crawl space(s), or slab on grade). In the last 20 years, vapor intrusion impacts have been demonstrated in occupied buildings at a number of sites across the country (e.g., Little et al. 1992). As a result, vapor intrusion is widely recognized as a potential pathway of human exposure to “volatile” hazardous chemicals in indoor spaces. When and where vapor intrusion occurs, concentrations of vapors can increase gradually in amount in buildings or structures as time passes (i.e., “accumulate”). Depending upon site- and building-specific circumstances, vapors of potentially toxic chemicals may accumulate to a point where the health of the occupants (e.g., residents, workers, etc.) in those buildings could be threatened.

In addition to their toxicity threats, methane and certain other vapor-forming chemicals can pose explosion hazards depending upon structure-, building-, and site-specific circumstances. Explosion hazards may pose an imminent and substantial danger to human health and public welfare.

Careful consideration of the vapor intrusion pathway is warranted at all sites where vapor-forming chemicals are present in the soil or groundwater aquifer (NRC 2013).

Section 2.0 describes the vapor intrusion pathway in greater detail.

---

<sup>15</sup> The ‘vadose zone’ is the soil zone between land surface and the groundwater table within which the moisture content is less than saturation (except in the capillary fringe). It is also referred to as the “unsaturated zone.”

<sup>16</sup> The terms ‘gas’ and ‘vapor’ refer the gaseous state, as distinguished from the liquid or solid state, of matter. Whereas “vapor” refers to a volatile chemical that may comprise only a portion of the total volume, ‘gas’ refers to the entire volume. For economy of words, this Technical Guide refers to vapor concentrations in soil gas as “soil gas concentrations.”

<sup>17</sup> Radon is a colorless, odorless, radioactive gas that is formed from the decay of radium, a radioactive element that occurs naturally in the soil and bedrock in many areas of the United States. Radon can also be emitted from certain uranium- or radium-containing products and wastes. For more information about radon, see: <http://www.epa.gov/radon/index.html>.



## 1.2 Statutory Authorities

Protection of human health is a critical mandate underlying several federal statutes, including the Comprehensive Environmental Response, Compensation, and Liability Act (CERCLA), as amended,<sup>18</sup> and the Resource Conservation and Recovery Act (RCRA), as amended.<sup>19</sup> Protection of human health is also a critical objective of the National Oil and Hazardous Substances Pollution Contingency Plan (NCP), which is the federal government's blueprint for responding to oil spills and releases of hazardous substances, pollutants, or contaminants.

The sources of authority and requirements for addressing subsurface vapor intrusion are the relevant statutes and regulations. On this basis, the EPA has broad authority and distinct responsibilities<sup>20</sup> to assess and, if warranted, mitigate vapor intrusion in residential and nonresidential<sup>21</sup> settings arising from a chemical release that causes subsurface contamination by volatile hazardous chemicals.<sup>22</sup> These actions may include sampling indoor air to assess exposure levels of building occupants to subsurface vapors and implementing interim mitigation measures to control, reduce, or eliminate exposure indoors to vapors emanating from subsurface vapor sources. Where such subsurface contamination includes vapor-forming chemicals (see Section 3.1) and underlies or is near buildings, EPA recommends that the potential for human health risk from vapor intrusion be evaluated throughout the cleanup life

---

<sup>18</sup> Amendments to CERCLA include the Small Business Liability Relief and Brownfields Revitalization Act.

<sup>19</sup> Application of these statutory authorities to a particular situation generally entails site- and fact-specific analysis.

<sup>20</sup> On January 23, 1987, the President of the United States signed Executive Order 12580 entitled, "Superfund Implementation," which delegates to a number of Federal departments and agencies the authority and responsibility to implement certain provisions of CERCLA. The policies and procedures for implementing these provisions (e.g., carrying out response actions) are spelled out in the NCP. The provisions of Executive Order 12580 appear at 52 *Federal Register* 2923.

<sup>21</sup> The EPA and the Occupational Safety and Health Administration (OSHA) of the Department of Labor each have a distinct statutory responsibility to ensure the safety and health of America's workforce through the timely and effective implementation of a number of federal laws and implementing regulations. On November 23, 1990, the Secretary of the Department of Labor and Administration of the EPA signed a Memorandum of Understanding (MOU) with the goal of establishing a program for improved environmental and workplace health and safety, which continues in effect. Implementation of the MOU is intended "to improve the combined efforts of the agencies to achieve protection of workers, the public, and the environment at facilities subject to EPA and OSHA jurisdiction; to delineate the general areas of responsibility of each agency; and to provide guidelines for coordination of interface activities between the two agencies with the overall goal of identifying and minimizing environmental or workplace hazards." An additional MOU was signed in February 1991 to establish a process and framework for notification, consultation and coordination between EPA and OSHA to aid both agencies in identifying environmental and workplace health and safety problems and to more effectively implement enforcement of their respective national environmental and workplace statutes. For additional information, see [https://www.osha.gov/pls/oshaweb/owasrch.search\\_form?p\\_doc\\_type=MOU&p\\_toc\\_level=1&p\\_keyvalue=Agency&p\\_status=CURRENT](https://www.osha.gov/pls/oshaweb/owasrch.search_form?p_doc_type=MOU&p_toc_level=1&p_keyvalue=Agency&p_status=CURRENT).

EPA's recommended approach for evaluating vapor intrusion exposures is based upon its existing risk assessment guidance, as summarized in Section 7.4.

<sup>22</sup> Section 3.1 of this Technical Guide describes technical criteria for identifying which specific chemicals are sufficiently volatile and hazardous to generally warrant routine evaluation during vapor intrusion assessments, when they are present as subsurface contaminants. These sufficiently volatile and hazardous chemicals are referred to as "vapor-forming chemicals" for purposes of this Technical Guide.

cycle (i.e., initial site assessment, site investigation, interim and final response actions,<sup>23</sup> and periodic reviews of the selected remedy), as described in Sections 5 and 6 of this Guide.

Although this Technical Guide is intended for use at any site subject to federal statutes, regulations, and rules, it is not intended to alter existing requirements, guidance, or practices among OSWER's programs about development, selection, or documentation of final remediation<sup>24</sup> plans (addressing subsurface vapor sources, for example).

EPA may need access to private property to conduct investigations, studies and response actions pursuant to CERCLA and RCRA, as amended. The Superfund Amendments and Reauthorization Act of 1986 and RCRA explicitly grant EPA the authority to enter property for these purposes (EPA 1986, 1987, 2010a). EPA generally prefers to obtain access through consent and cooperation. If consent is denied, however, EPA can use the judicial process or an administrative order to gain access. Application of legal doctrines to a particular access situation warrants site- and fact-specific analysis.

Provisions under CERCLA, RCRA, federal regulations, and federal guidance also provide authority and support for taking early actions to mitigate actual and potential human health risks, as discussed below. In the context of vapor intrusion, "early action" may include response measures such as engineered exposure controls to reduce or eliminate vapor intrusion in buildings (i.e., "mitigate" vapor intrusion) or reduce indoor air exposure levels (see Sections 7.8 and 8.2) and 'prompt' response actions to address more urgent threats to human health or public welfare (see Section 7.5).

### 1.2.1 Taking Action with Limited Data under CERCLA and the NCP

CERCLA and the NCP both contain provisions that support and encourage taking early actions to mitigate actual and potential threats to human health associated with vapor intrusion. For example, CERCLA sections 104 and 106 provide the federal government with broad authority to take response action(s) to address a release or threatened release of hazardous substances that "may present" a human health risk. Similarly, the preamble to the final NCP issued in the *Federal Register* on March 8, 1990 (55 FR 8704), states, "EPA expects to take early action at sites where appropriate, and to remediate sites in phases using operable units as early actions to eliminate, reduce or control the hazards posed by a site or to expedite the completion of total site cleanup. In deciding whether to take early actions, EPA balances a number of considerations, including the desire to definitively characterize site risks and analyze alternative remedial approaches for addressing those threats in great detail with the desire to implement protective measures quickly. EPA intends to perform this balancing with a bias for initiating

---

<sup>23</sup> The words "response action" or "response" are used generically in this Technical Guide to include remedial and removal actions under CERCLA as amended and similar actions under RCRA as amended.

<sup>24</sup> For purposes of this Technical Guide, "remediation" is intended to apply to interim and final cleanups, whether conducted pursuant to RCRA corrective action, the CERCLA removal or remedial programs, or using EPA brownfield grant funds with oversight by state and tribal response programs. In addition to permanent remedies for subsurface vapor sources, site remediation may also entail implementation of institutional controls and construction and operation of engineered systems.

response actions necessary or appropriate to eliminate, reduce, or control hazards posed by a site as early as possible.”<sup>25</sup>

For sites that are not on the National Priorities List (NPL), EPA may use its removal authority under CERCLA to undertake early action to mitigate vapor intrusion threats. For sites that are on the NPL, EPA's Superfund program may use its remedial or removal authority under CERCLA to undertake early action to ensure the protection of human health during existing or future property uses that could be affected by vapor intrusion. Building mitigation, control of subsurface vapor source(s), and associated ICs could be part of a final remedy selected for the site, or where appropriate, could represent an early action that (1) is evaluated and selected on a faster track and (2) complements the anticipated final remedial action for the site.

Because of state cost-share consequences, EPA recommends that state concurrence be sought for any Fund-lead mitigation under CERCLA where there is a reasonable expectation that the state will need to take over responsibility for operations and maintenance (O&M) as part of a long-term, final remedy.

EPA's guidance for preparing Superfund decision documents states: “An interim action is limited in scope and only addresses areas/media that also will be addressed by a final site/operable unit ROD [Record of Decision]. . . . Early actions can be taken throughout the RI/FS [remedial investigation/feasibility study] process to initiate risk reduction activities. . . . “Early” in this case is simply a description of when the action is taken in the Superfund process. Thus, an early action is one that is taken before the RI/FS for the site or operable unit has been completed. Hence, early actions may be either interim or final” (EPA 1999b). The primary goals of an early action are to “achieve prompt risk reduction and increase the efficiency of the overall site response” (EPA 1992b). Although preparation of an RI/FS Report is not essential for an early action, documentation that supports the rationale for the action and becomes part of Administrative Record is recommended, consistent with the NCP and CERCLA. For interim actions, EPA's guidance for preparing Superfund decision documents states: “A summary of site data collected during field investigations should be sufficient to document a problem in need of response. In addition, a short analysis of remedial alternatives considered, those rejected, and the basis for the evaluation (as is done in a focused FS) should be summarized to support the selected action” (EPA 1999b).

For response actions selected in an Action Memorandum or Record of Decision which are carried out by potentially responsible parties (PRPs), and where the PRP(s) agree to implement preemptive mitigation (PEM) for vapor intrusion, EPA recommends that PRP commitments to proceed with response action (including early action) be obtained through settlements or other enforcement documents (for example, administrative orders). Such response action commitments could include performance of O&M and monitoring. EPA recommends that settlement with PRPs concerning PEM/early action response actions specify that PRPs agree not to challenge the basis of the response based on inadequate characterization.

---

<sup>25</sup> So, for example, EPA cited the NCP in its *Compilation of Information Relating to Early/Interim Actions at Superfund Sites and the TCE IRIS Assessment* (EPA 2014b).

### 1.2.2 Taking Action with Limited Data under RCRA Corrective Action

EPA has emphasized the importance of interim actions and site stabilization in the RCRA corrective action program to control or abate “ongoing risks” to human health and the environment while site characterization is underway or before a final remedy is selected (see the *Federal Register* of May 1, 1996 [61 FR 19446]). Interim actions encompass a wide range of institutional and physical corrective action activities to achieve stabilization and can be implemented at any time during the corrective action process. EPA recommends that interim actions, including PEM, be employed as early in the corrective action process as possible, consistent with the human health and environmental protection objectives and priorities for the site. EPA recommends that, as further information is collected, program implementers continue to look for opportunities to conduct additional interim response actions.

### 1.3 Scope and Recommended Uses of this Technical Guide

This Technical Guide presents EPA’s current recommendations for how to identify and consider key factors when assessing vapor intrusion, making risk management decisions, and implementing mitigation pertaining to this potential human exposure pathway. This Technical Guide and the accompanying *Technical Guide For Addressing Petroleum Vapor Intrusion At Leaking Underground Storage Tank Sites* (EPA 2015b) supersede and replace EPA’s *Draft Guidance for Evaluating the Vapor Intrusion to Indoor Air Pathway from Groundwater and Soils* (EPA 2002c) (“Draft VI Guidance”). One of the main purposes of this Technical Guide is to promote national consistency in assessing the vapor intrusion pathway.<sup>26</sup> At the same time, it provides a flexible science-based approach to assessment that accommodates the different circumstances (e.g., stage of the cleanup process) at a site and differences among pertinent EPA programs.

This Technical Guide is intended for use at any site<sup>27</sup> being evaluated by EPA pursuant to CERCLA or RCRA corrective action, EPA’s brownfield grantees, or state agencies acting

---

<sup>26</sup> If EPA staff wish to consider using any specific guidance that is not explicitly recommended in this Technical Guide, they should consult with Headquarters.

<sup>27</sup> The term “site” is used generically in this Technical Guide to represent areas of contamination managed in a cleanup project under CERCLA as amended, under RCRA as amended, at a federal facility, or pursuant to an EPA Brownfields grant.

pursuant to CERCLA or an authorized RCRA corrective action program<sup>28</sup> where vapor intrusion may be of potential concern. EPA recommends consideration of this Technical Guide when:

- Making “Current Human Exposures Under Control” environmental indicator (EI) determinations at RCRA corrective action facilities (EPA 1999a, 2002b)<sup>29</sup> and National Priorities List (NPL) sites under CERCLA (EPA 2008b);
- Undertaking removal actions, remedial actions, pre-remedial investigations,<sup>30</sup> remedial investigations, and five-year reviews (FYRs)<sup>31</sup> and selecting remedies under CERCLA; and
- Undertaking RCRA facility investigations and corrective actions and site investigations and cleanups at federal facilities and brownfield sites.

This Technical Guide addresses both residential and nonresidential buildings that may be impacted by vapor intrusion from subsurface vapor sources.

The broad concepts of this Technical Guide generally may be appropriate when evaluating any of a large number and broad range of vapor-forming chemicals— described in Section 3.1 — that potentially can provide subsurface sources for vapor intrusion into buildings. These chemicals include, for example, chlorinated hydrocarbons (CHCs), petroleum hydrocarbons, other types of both halogenated and non-halogenated volatile organic compounds (VOCs),

---

<sup>28</sup> EPA believes that states, tribes, and local governments will find this Technical Guide useful for their respective programs. EPA recommends that state agencies that have delegated authority to implement CERCLA or RCRA consider this Technical Guide when implementing their state-specific guidance for vapor intrusion assessment and mitigation, if any, (e.g., ensure they incorporate features such as: using multiple lines of evidence to support pathway- or incomplete determinations and “no-further-action” decisions; collecting multiple rounds of indoor air sampling to characterize exposure levels in indoor air in existing buildings and reduce the chance of reaching a false-negative conclusion (i.e., concluding exposure is at an acceptable risk level when it is not) or a false-positive conclusion (i.e., concluding vapor intrusion poses unacceptable human health risk, when it does not); focusing lab analyses of indoor air, ambient air, and sub-slab soil gas samples on vapor-forming chemicals known or suspected to be released to the subsurface environment; invoking the recommended criteria described in Section 6.5.2 as a condition for using risk-based screening levels for vapor intrusion; assessing human health risk posed by less-than-chronic exposure durations; and considering reasonably expected future conditions, as well as current conditions, when making risk management decisions and selecting cleanup and building mitigation plans).

<sup>29</sup> Also see <http://www.epa.gov/osw/hazard/correctiveaction/eis/faqs.htm>.

<sup>30</sup> CERCLA authorizes the EPA to identify and prioritize which sites warrant further investigation to ascertain whether remedial action is needed. The Hazard Ranking System (HRS) is the statutorily required method for evaluating and identifying sites for placement on the NPL.

<sup>31</sup> Section 121 of CERCLA specifies that remedial actions that result in any hazardous substances, pollutants, or contaminants remaining at the site be re-evaluated every five years to ensure that the remedy is and will continue to be protective of human health and the environment. OSWER Directive 9200.2-84 (*Assessing Protectiveness at Sites for Vapor Intrusion: Supplemental Guidance to the Comprehensive Five-Year Review Guidance* (EPA 2012c)) provides supplemental guidance for considering vapor intrusion while evaluating remedy protectiveness in the context of the Superfund five-year review process (even if vapor intrusion was not addressed as part of the original remedial action).

elemental mercury, and radon when it arises from uranium- or radium-bearing solid wastes in the subsurface.<sup>32</sup>

This Technical Guide addresses risk management (e.g., exposure control or avoidance methods) for indoor air contamination that arises from vapor intrusion from subsurface sources of these vapor-forming chemicals. It is not intended as a guide for assessing or mitigating indoor air exposures that arise solely from other sources (e.g., indoor use and storage of certain consumer products<sup>33</sup>).

The exposure route of general interest for vapor intrusion is inhalation<sup>34</sup> of vapors present in indoor air that have entered via soil gas entry from the subsurface.<sup>35</sup> Other human exposure routes that may warrant consideration during site investigations of subsurface contamination (e.g., ingestion of soil or water, dermal contact with soil or water, inhalation of particulate material, inhalation of vapors while outdoors, and inhalation of vapors while showering or washing with contaminated groundwater while indoors) are not addressed in this Technical Guide.

EPA recommends that risk management and response action decisions for the vapor intrusion pathway generally consider reasonably expected future conditions, which may differ from current conditions due to changes in land use, building and infrastructure construction and conditions, and vadose zone hydrology and oxygenation, among other factors. This Technical Guide provides general information regarding how these factors may enhance or impede vapor intrusion. It also provides recommendations for institutional controls and monitoring where a subsurface vapor source(s) is(are) present and has the potential to pose unacceptable human health risks.

Although this Technical Guide is intended for use at any site subject to federal statutes, regulations, and rules, it is not intended to alter existing requirements, guidance, or practices among OSWER's programs about circumstances for reviewing past risk management and cleanup decisions. As noted, remedy reviews are required by Section 121 of CERCLA when

---

<sup>32</sup> Radon emanating from natural geological materials may also affect indoor air quality in occupied buildings, but is not a subject of this Technical Guide. According to EPA estimates, inhalation of toxic radon decay products is the leading cause of lung cancer among non-smokers. For more information about radon emanating from natural geological materials, see: <http://www.epa.gov/radon/index.html>.

<sup>33</sup> Indoor air in most buildings will contain detectable levels of a number of volatile compounds, whether or not the building overlies a subsurface source of vapor-forming chemicals (EPA 2011a). As discussed further in Section 2.7 of this Technical Guide, these chemicals originate from indoor uses of chemical-containing products (e.g., household or consumer products) and from outdoor (ambient) air. EPA's indoor air quality program provides useful advice for control of indoor air exposures (see <http://www.epa.gov/iaq/>).

<sup>34</sup> Among human exposure pathways involving contamination of land and water, vapor intrusion is distinct. Whereas contact with contaminated surface soil, contaminated fish, and contaminated drinking water generally can be readily avoided for prolonged periods, breathing cannot.

<sup>35</sup> In addition, certain hazardous chemicals (e.g., methane) can pose explosion hazards when they gradually increase in amount in structures (e.g., confined spaces) or buildings as time passes to a point where there is an imminent and substantial danger to human health and public welfare.

hazardous substances remain on site.<sup>36</sup> EPA's other land restoration programs (e.g., RCRA corrective action, brownfield redevelopment) will continue to rely upon their existing, respective practices to address the need, if any, for periodic reviews of cleanup decisions, including consideration of the vapor intrusion pathway.

Finally, this Technical Guide does not aim or intend to:

- Offer recommendations for vapor intrusion assessments that private parties choose to conduct as part of real estate transactions;
- Modify existing guidance regarding landowner liability protection (e.g., all appropriate inquiries, the *bona fide* prospective purchaser provision); or
- Offer recommendations for responding to leaks from natural gas transmission lines.

### 1.3.1 Petroleum Hydrocarbons

The approaches in this Technical Guide are recommended for evaluating the vapor intrusion pathway pursuant to CERCLA or RCRA corrective action for petroleum hydrocarbons that are mixed with other types of volatile hazardous chemicals or are the result of releases from sources other than Subtitle I underground storage tank (UST) systems.<sup>37</sup> For petroleum hydrocarbons that arise from petroleum that has been released from Subtitle I UST systems, EPA has developed a companion to this Technical Guide (*Technical Guide For Addressing Petroleum Vapor Intrusion At Leaking Underground Storage Tank Sites* (EPA 2015b)), which provides information and guidance about assessing vapor intrusion from petroleum hydrocarbons in these settings and may also be useful in informing decisions about vapor intrusion and petroleum hydrocarbons at non-UST sites that are similar in size to a typical Subtitle I UST release.

Many petroleum hydrocarbons may naturally biodegrade in the vadose zone through the actions of microorganisms found naturally in soil. When oxygen supply from the atmosphere is sufficient, biodegradation of petroleum hydrocarbons can occur relatively quickly, will generally produce less harmful compounds (i.e., biodegradation products), and can result in substantial attenuation of petroleum hydrocarbon vapors over relatively short distances in the vadose zone.

Numerous site-specific factors can influence the biodegradation rate of petroleum hydrocarbons (and other biodegradable vapor-forming chemicals) in the vadose zone. These factors include quantities, distribution, types, and mixtures of vapor-forming chemicals, which can differ substantially among sites where petroleum hydrocarbons are released to the subsurface

---

<sup>36</sup> The NCP states [40 *CFR* 300.430(f)(4)(ii)]: "If a remedial action is selected that results in hazardous substances, pollutants, or contaminants remaining at the site above levels that allow for unlimited use and unrestricted exposure, the lead agency shall review such action no less often than every five years after initiation of the selected remedial action." For further information, see, for example, <http://www.epa.gov/superfund/cleanup/postconstruction/5yr.htm>

<sup>37</sup> For example, the approaches in this Technical Guide are recommended for evaluating the vapor intrusion pathway associated with subsurface releases of petroleum, petroleum derivatives, and petroleum hydrocarbons from refineries, bulk storage facilities, oil exploration and production sites, pipelines and transportation, chemical manufacturing facilities, former manufactured gas plants, creosote (wood-treating) facilities, large-scale fueling and storage operations at federal facilities, and dry cleaners that use petroleum solvents.

environment. This Technical Guide allows site-specific observations of the effects of biodegradation to be considered in its approach for petroleum hydrocarbons (and any other biodegradable, vapor-forming chemical). Sections 6.3.2 and 7.3 expand on EPA's recommended approach to evaluating biodegradation of vapor-forming chemicals in the vadose zone at sites with subsurface contamination.

### 1.3.2 Nonresidential Buildings

EPA has broad authority and distinct responsibilities to assess and, if warranted, mitigate vapor intrusion in nonresidential settings arising from a chemical release that causes subsurface contamination by volatile hazardous chemicals (see Section 1.2). EPA<sup>38</sup> is authorized to take all appropriate actions to protect human health and the environment from subsurface vapor sources of chemical exposure consistent with applicable federal statutes<sup>39,40</sup> and regulations and considering EPA guidance,<sup>41</sup> taking into account the nonresidential setting. These actions may include sampling indoor air to assess exposure levels of building occupants to subsurface vapor sources and implementing interim mitigation measures to control, reduce, or eliminate exposure indoors to vapors emanating from a subsurface vapor source(s).

As used in this Technical Guide, the phrase "nonresidential buildings" may include, but is not limited to, institutional buildings (e.g., schools, libraries, hospitals, community centers and other enclosed structures for gathering, gyms and other enclosed structures for recreation); commercial buildings (e.g., hotels, office buildings, many (but not all) day care facilities, and retail establishments); and industrial buildings where vapor-forming chemicals may or may not be routinely used or stored. Section 4.0 expands on EPA's recommended approach to evaluating and mitigating vapor intrusion in nonresidential buildings.

## 1.4 Companion Documents and Technical Resources

Technical information pertaining to vapor intrusion has also been prepared to support development of and facilitate implementation of the technical approaches and recommendations in this Technical Guide. Key technical information is described in this section and can be found on OSWER's vapor intrusion website (see Section 11.0 for citations and internet links).

---

<sup>38</sup> On January 23, 1987, the President of the United States signed Executive Order 12580 entitled, "Superfund Implementation," which delegates to a number of Federal departments and agencies the authority and responsibility to implement certain provisions of CERCLA. The policies and procedures for implementing these provisions (e.g., carrying out response actions) are spelled out in the NCP. The provisions of Executive Order 12580 appear at 52 *Federal Register* 2923. At federal facilities on the NPL, EPA may not be the lead agency, but does have oversight responsibilities pursuant to CERCLA Section 120.

<sup>39</sup> CERCLA and RCRA authorize EPA to protect human health and the environment, as summarized in Section 1.2 of this Technical Guide. The NCP also addresses protection of human health and the environment.

<sup>40</sup> See, for example, CERCLA Section 101(22).

<sup>41</sup> See, for example, OSWER Directive 9355.0-30 (*Role of the Baseline Risk Assessment in Superfund Remedy Selection Decisions*) (EPA 1991a) and *Rules of Thumb for Superfund Remedy Selection*, OSWER Directive 9355.0-69, August 1997 (EPA 1997).



### 1.4.1 Vapor Intrusion Screening Level Calculator

The Vapor Intrusion Screening Level (VISL) Calculator (2015a) is a technical resource, developed by EPA that:

- (1) Identifies chemicals considered to be typically vapor-forming and known to pose a potential cancer risk or noncancer hazard through the inhalation pathway (as described further in Section 3.1 herein);
- (2) Provides generally recommended screening-level concentrations for groundwater, near-source soil gas (exterior to buildings), sub-slab soil gas, and indoor air based upon default residential or nonresidential exposure scenarios, a target cancer risk level of one per million ( $10^{-6}$ ), and a target hazard quotient of one for potential non-cancer effects; and
- (3) Facilitates calculation of site-specific screening levels (see Section 6.5) and/or candidate cleanup levels (see Section 7.6) based on user-defined target risk levels, exposure scenarios, and semi-site-specific (Appendix A) or site-specific (Section 7.6) attenuation factors.

The VISL Calculator is comprised of an MS Excel workbook. It can be used in evaluating whether the vapor intrusion pathway has the potential to pose a human health risk by helping to:

- (1) Identify whether volatile hazardous chemicals that can pose a threat through vapor intrusion are present;
- (2) Determine if those volatile hazardous chemicals are present at potentially explosive levels;
- (3) Compare subsurface or indoor data against recommended screening levels provided in the VISL Calculator; and
- (4) Prioritize buildings and sites for investigation and response action.

The recommended screening-level concentrations in the spreadsheet are calculated using the recommended approaches in existing EPA guidance for human health risk assessment, as described further in Sections 6.5.2 and 6.5.3 herein, and are based on current understanding of the vapor intrusion pathway.

### 1.4.2 Technical Support Documents

Key technical documents supporting development of the technical approaches and recommendations in this Technical Guide include:

*Background Indoor Air Concentrations of Volatile Organic Compounds in North American Residences (1990-2005): A Compilation of Statistics for Assessing Vapor Intrusion (EPA 2011a)*: This technical report presents (1) a summary of indoor air studies that measured background concentrations of VOCs in the indoor air of thousands of North American residences and (2) an evaluation and compilation of the statistical information reported in these studies. The objective of this compilation is to illustrate the ranges and variability of

VOC concentrations in indoor air during the study period (1990-2005), resulting from sources other than vapor intrusion. This technical report was externally peer reviewed, consistent with EPA's peer review policy (EPA-SPC 2006) for scientific and technically based work products that are intended to inform Agency decisions.

*EPA's Vapor Intrusion Database: Evaluation and Characterization of Attenuation Factors for Chlorinated Volatile Organic Compounds and Residential Buildings (EPA 2012a)*: This technical report presents technical information about sites in the U.S. that have been investigated for vapor intrusion. The primary focus of the report is the evaluation of concentrations of chlorinated VOCs in and underneath residential buildings based upon the EPA's vapor intrusion database as of 2010. This report provides the technical basis for the generic and semi-site-specific attenuation factors recommended in this Technical Guide to calculate vapor intrusion screening levels (see Section 6.5 and Appendix A). This technical report was externally peer reviewed, consistent with EPA's peer review policy (EPA-SPC 2006) for scientific and technically based work products that are intended to inform Agency decisions.

*Conceptual Model Scenarios for the Vapor Intrusion Pathway (EPA 2012b)*: This technical report provides simplified simulation examples to illustrate graphically how subsurface conditions and building-specific characteristics determine: (1) the distribution of vapor-forming chemicals in the subsurface; and (2) the indoor air concentration relative to a source concentration. It was prepared to help environmental practitioners gain insights into the processes and variables involved in the vapor intrusion pathway and to provide a theoretical framework with which to draw inferences about and better understand the complex vapor fate and transport conditions typically encountered at actual, contaminated sites. This technical report was externally peer reviewed, consistent with EPA's peer review policy (EPA-SPC 2006) for scientific and technically based work products that are intended to inform Agency decisions.

These technical tools and documents, as well as others, can be found at <http://www.epa.gov/oswer/vaporintrusion>, a website developed to support the development of this Technical Guide and enhance public communication about the topic. This website also allows certain sections of this Technical Guide to be more dynamic and facilitates updates to information.

Technical documents intended to facilitate consideration of the recommendations in the *Technical Guide For Addressing Petroleum Vapor Intrusion At Leaking Underground Storage Tank Sites* (EPA 2015b) can be found at <http://www.epa.gov/oust/cat/pvi/>.

## 1.5 Historical Context

To help assess the subsurface vapor intrusion pathway, the Office of Solid Waste and Emergency Response (OSWER) released in November 2002 for comment EPA's Draft VI Guidance, which presents EPA's technical information and recommendations for evaluating subsurface vapor intrusion, based on the understanding of vapor intrusion at that time (EPA 2002c). This Technical Guide and the accompanying *Technical Guide For Addressing Petroleum Vapor Intrusion At Leaking Underground Storage Tank Sites* (EPA 2015b) supersede and replace the Draft VI Guidance.

Since the Draft VI Guidance was released, EPA's knowledge of and experience with assessment and mitigation of the vapor intrusion pathway has increased considerably, leading to an improved understanding of and enhanced approaches for evaluating and managing vapor intrusion. In addition:

- Other federal agencies with responsibilities and obligations for environmental cleanup or for response to reports of vapor intrusion have developed vapor intrusion guides for their respective programs (e.g., ATSDR 2008; DoD 2009; DoN 2011a; USPS 2009).
- A number of state agencies involved with environmental quality or public health protection have developed vapor intrusion guides for their programs, which they may continue to implement under their respective statutory authorities (e.g., see ASTSWMO [2009], a compilation).
- The Interstate Technology & Regulatory Council (ITRC), a state-led coalition of environmental regulatory professionals, prepared three guidelines for assessing the vapor intrusion pathway (ITRC 2007ab, 2014).

EPA has considered these guides in developing this Technical Guide.

In addition, in December 2009, the OIG made recommendations regarding EPA's Draft VI Guidance, which are documented in the evaluation report *Lack of Final Guidance on Vapor Intrusion Impedes Efforts to Address Indoor Air Risks* (Report No. 10-P-042; EPA 2009a). Among other things, the OIG recommended that the final guidance incorporate:

- Updated toxicity values.
- A recommendation(s) to collect and weigh multiple lines of evidence in evaluating and making decisions about human health risks posed by vapor intrusion.
- How risks from petroleum hydrocarbon vapors should be addressed.
- How the guidance applies to Superfund FYRs.
- When or whether preemptive mitigation is appropriate.
- Operations, maintenance, and termination of mitigation systems.
- When institutional controls are appropriate.

In its response letter dated March 11, 2010, OSWER generally agreed with OIG's recommendations to finalize guidance on vapor intrusion. In addition, the OIG recommended

that EPA identify and publicly report the portions of its Draft VI Guidance that remain valid and the portions that would be updated.<sup>42</sup>

This Technical Guide and the companion documents identified in Sections 1.3 and 1.4 fulfill EPA's commitment to address the OIG's recommendations. Table 1-1 identifies specific updates prepared by EPA in response to OIG's specific recommendations. Table 1-2 describes additional updates identified and publicly announced by EPA (EPA 2010b).

**TABLE 1-1**  
**DIRECTORY TO UPDATES IN THIS TECHNICAL GUIDE ADDRESSING**  
**RECOMMENDATIONS OF EPA OFFICE OF INSPECTOR GENERAL (EPA 2009A)**

Topics to Be Addressed	Location Within This Technical Guide	Companion Documents
Update toxicity values		<i>VISL Calculator</i> (EPA 2015a)
Use of multiple lines of evidence in evaluating and making decisions about risks from vapor intrusion	Sections 5, 6, and 7	
How risks from petroleum hydrocarbon vapors should be addressed	Sections 1.3.1, 6.3.2 and 7.3	<i>Technical Guide for Addressing Petroleum Vapor Intrusion at Leaking Underground Storage Tank Sites</i> (EPA 2015b)
How this Technical Guide applies to Superfund Five-year Reviews (FYRs)		<i>Assessing Protectiveness at Sites for Vapor Intrusion: Supplemental Guidance to the Comprehensive Five-Year Review Guidance</i> (EPA 2012c)
When or whether preemptive mitigation/early action is appropriate	Sections 3.3 and 7.8	
Operations and maintenance of mitigation systems	Section 8.3	
Termination of mitigation systems	Section 8.7	
When ICs and deed restrictions are appropriate.	Section 8.6	

<sup>42</sup> OSWER carried out this recommendation by issuing a memorandum in August 2010, entitled *Review of the Draft 2002 Subsurface Vapor Intrusion Guidance* (EPA 2010b). The guidance reflected in this memorandum is incorporated in this Technical Guide.

**TABLE 1-2**  
**DIRECTORY TO ADDITIONAL UPDATES IN THIS TECHNICAL GUIDE PUBLICLY IDENTIFIED BY OSWER (EPA 2010B)**

<b>Topics to Be Updated, Including References to the Draft VI Guidance</b>	<b>Location Within This Technical Guide</b>	<b>Companion Technical Document or Resource</b>
Updated a few chemical-specific physical parameters used for identifying the vapor-forming chemicals of concern.	Section 3.1	VISL Calculator (EPA 2015a)
Updated the toxicity-based criteria in Table D-1 in the draft guidance.	Section 3.1	VISL Calculator (EPA 2015a)
Observation-based conservative attenuation factors have been updated with a larger database. The generic attenuation factor for external soil gas has been updated, as well as the Reliability Assessment, using the newer available data.	Section 6.5.3 and Appendix A	<i>U.S. EPA's Vapor Intrusion Database: Evaluation of Attenuation Factors for Chlorinated Volatile Organic Compounds and Residential Buildings</i> (EPA 2012a)
Observational data since 2002 indicates that the "single line of evidence" approach with site-estimated attenuation factors is generally not appropriate for external soil gas samples.	Section 6.4.4 and Appendix A	
Experiences since 2002 illustrate the value of collecting indoor air samples earlier in the investigations. The "indoor air last" approach has been updated, which will allow more flexibility in the sequencing of subsurface and interior/indoor sample collection.	Sections 6.3.4 and 6.3.6	
The portions addressing background contamination have been updated. EPA also updated with more specific methodologies for evaluating and/or decision-making and managing background contamination.	Sections 6.3.5, 7.4 and 7.6	<i>Background Indoor Air Concentrations of Volatile Organic Compounds in North American Residences (1990-2005): A Compilation of Statistics for Assessing Vapor Intrusion</i> (EPA 2011a)
The portion of this Technical Guide focusing on testing indoor air has been updated to allow more flexibility in the duration of sampling to take advantage of other sampling durations and methods.	Section 6.4.1	
The Draft VI Guidance allows site-specific decisions to be made based on indoor air concentrations in a relatively few representative buildings. This portion of this Technical Guide has been updated to increase the confidence that the approach fully addresses building-by-building variability.	Sections 6.2.2 and 7.8	
Updated and expanded the community involvement information to be more specific to vapor intrusion sites, including guidelines for effective risk communication and available resources, outreach products and tools for outreach.	Section 9	

## 1.6 Public Involvement in Developing this Vapor Intrusion Technical Guide

On November 29, 2002, EPA published a notice in the *Federal Register* (67 FR 71169) announcing and soliciting comment on its Draft VI Guidance. Since that time, EPA continued to gather information and learn more about vapor intrusion, in part by convening periodic forums where practitioners, regulated parties, and regulators could discuss the emerging science and engineering pertaining to vapor intrusion assessment and mitigation. In addition, on March 17, 2011, EPA published a notice in the *Federal Register* (76 FR 14660) re-opening the docket and soliciting additional comment on its development efforts for this Technical Guide. The docket was re-opened again in March 2012 to receive comments about specific technical documents that were prepared to support development of this Technical Guide; these technical documents are listed in Section 1.4. Finally, another review draft was released on April 16, 2013 for public comment. In developing and refining this Technical Guide, EPA considered all public comments and input received since 2002.

EPA also proactively engaged communities beyond the traditional outreach practices, especially environmental justice communities and communities subject to multiple stressors.<sup>43</sup> Aspects of this engagement have included:

- Conducting public listening sessions in communities impacted by vapor intrusion to solicit input on developing this Technical Guide.
- Using Internet sites and other communication tools to update stakeholders on the progress of developing this Technical Guide.

Table 1-3 identifies specific vapor intrusion topics that have received substantive public comment as a result of EPA's outreach efforts.

## 1.7 Organization

The next nine sections of this Technical Guide are as follows:

- Section 2.0 Conceptual Model of Vapor Intrusion further describes vapor intrusion and identifies many of the variables that influence vapor migration in the vadose zone and soil gas entry into buildings.
- Section 3.0 Overview of this Vapor Intrusion Technical Guide provides an overview of this Technical Guide and the general recommended framework for vapor intrusion assessment and response action.
- Section 4.0 Considerations for Nonresidential Buildings provides information regarding EPA roles, responsibilities, and risk management decision-making in nonresidential settings, including those (e.g., manufacturing facilities) where workers handle volatile hazardous chemicals similar to or different from those contaminating the subsurface.

---

<sup>43</sup> For more information about the Community Engagement Initiative visit:  
<http://www.epa.gov/oswer/engagementinitiative/>

**TABLE 1-3**  
**VAPOR INTRUSION TOPICS RECEIVING SUBSTANTIVE PUBLIC COMMENT**

Topics	Location Within This Technical Guide	Companion Document(s)
Applicability to petroleum hydrocarbons	Sections 1.3.1, 6.3.2 and 7.3	<i>Technical Guide for Addressing Petroleum Vapor Intrusion at Leaking Underground Storage Tank Sites (EPA 2015b)</i>
Applicability to nonresidential buildings	Sections 1.3.2, 4.0 and 7.4.3	
Conditions warranting prompt response action	Sections 5.2, 7.5 and 8.2.1	
Planning investigations and applying data quality objectives	Section 6.2 and Appendix B	
Sampling and monitoring methods for indoor air	Section 6.4.1	
Attenuation factors and risk-based screening	Section 6.5 and Appendix A	<i>U.S. EPA's Vapor Intrusion Database: Evaluation of Attenuation Factors for Chlorinated Volatile Organic Compounds and Residential Buildings (EPA 2012a)</i>
Semi-site-specific screening and application of mathematical models	Sections 6.5 and 6.6	
Use of conceptual site models and multiple lines of evidence in evaluating risks posed by vapor intrusion	Sections 2, 3.2, 5.4, 6.3 and 7	
Risk management benchmarks and decision-making	Section 7	
Use of institutional controls for building mitigation	Section 8.6	
Monitoring and termination of mitigation systems	Sections 8.4 and 8.7	
Risk communication	Section 7.4 and 9	

- Section 5.0 Preliminary Analysis of Vapor Intrusion provides technical information for situations where only limited site-specific data may be available (e.g., initial site assessment).
- Section 6.0 Detailed Investigation of Vapor Intrusion provides technical information for conducting site-specific vapor intrusion assessments emphasizing multiple lines of evidence, including consideration of background concentrations.
- Section 7.0 Risk Assessment and Management Framework provides general recommendations about data evaluations and risk-informed decision-making pertaining to vapor intrusion, including consideration of background concentrations.
- Section 8.0 Building Mitigation and Subsurface Remediation provides technical information for mitigating vapor intrusion and describes how subsurface vapor source remediation and other final cleanup actions are combined with engineered and non-engineered exposure controls to ensure protection of human health.
- Section 9.0 Planning for Community Involvement provides information and describes available resources for engaging affected communities and communicating risk-related information.
- Section 10.0 Glossary provides definitions and descriptions of key terms used in this document.

This Technical Guide concludes with Section 11.0, Citations and References, and three supporting appendices:

- Appendix A: Recommended Subsurface-to-Indoor-Air Attenuation Factors.
- Appendix B: Data Quality Assurance Considerations.
- Appendix C: Calculating Vapor Source Concentration from Groundwater Sampling Data.



## 2.0 CONCEPTUAL MODEL OF VAPOR INTRUSION

This section presents a general (i.e., not site-specific) conceptual model of vapor intrusion, borrowing from published depictions (EPA 2008a; EPA 2012b; ITRC 2007a; McAlary et al. 2011; DoD 2009). It identifies and describes the ‘what’, ‘where’, ‘how’ and ‘why’ of vapor intrusion, to provide insights about the many of the lines of evidence pertinent to evaluating vapor intrusion on a site-specific basis, which are discussed further in Sections 5, 6, and 7 of this Technical Guide.<sup>44</sup> It concludes with several general observations that may assist practitioners when planning and conducting detailed vapor intrusion investigations at specific sites, which is the subject of Section 6 of this Technical Guide.

Vapor intrusion is a potential human exposure pathway – a way that people may come into contact with hazardous vapors while performing day-to-day indoor activities. Figure 2-1 summarizes the vapor intrusion pathway for soil gas entry. For purposes of this Technical Guide, the vapor intrusion pathway is referred to as “complete”<sup>45</sup> for a specific building or collection of buildings when the following five conditions are met under current conditions:

1. A subsurface source of vapor-forming chemicals is present (e.g., in the soil or in groundwater) underneath or near the building(s);
2. Vapors form and have a route along which to migrate (be transported) toward the building(s);
3. The building(s) is(are) susceptible to soil gas entry, which means openings exist for the vapors to enter the building and driving ‘forces’ exist to draw the vapors from the subsurface through the openings into the building(s);
4. One or more vapor-forming chemicals comprising the subsurface vapor source(s) is (or are) also present in the indoor environment; and
5. The building(s) is (or are) occupied by one or more individuals when the vapor-forming chemical(s) is (or are) present indoors.<sup>46</sup>

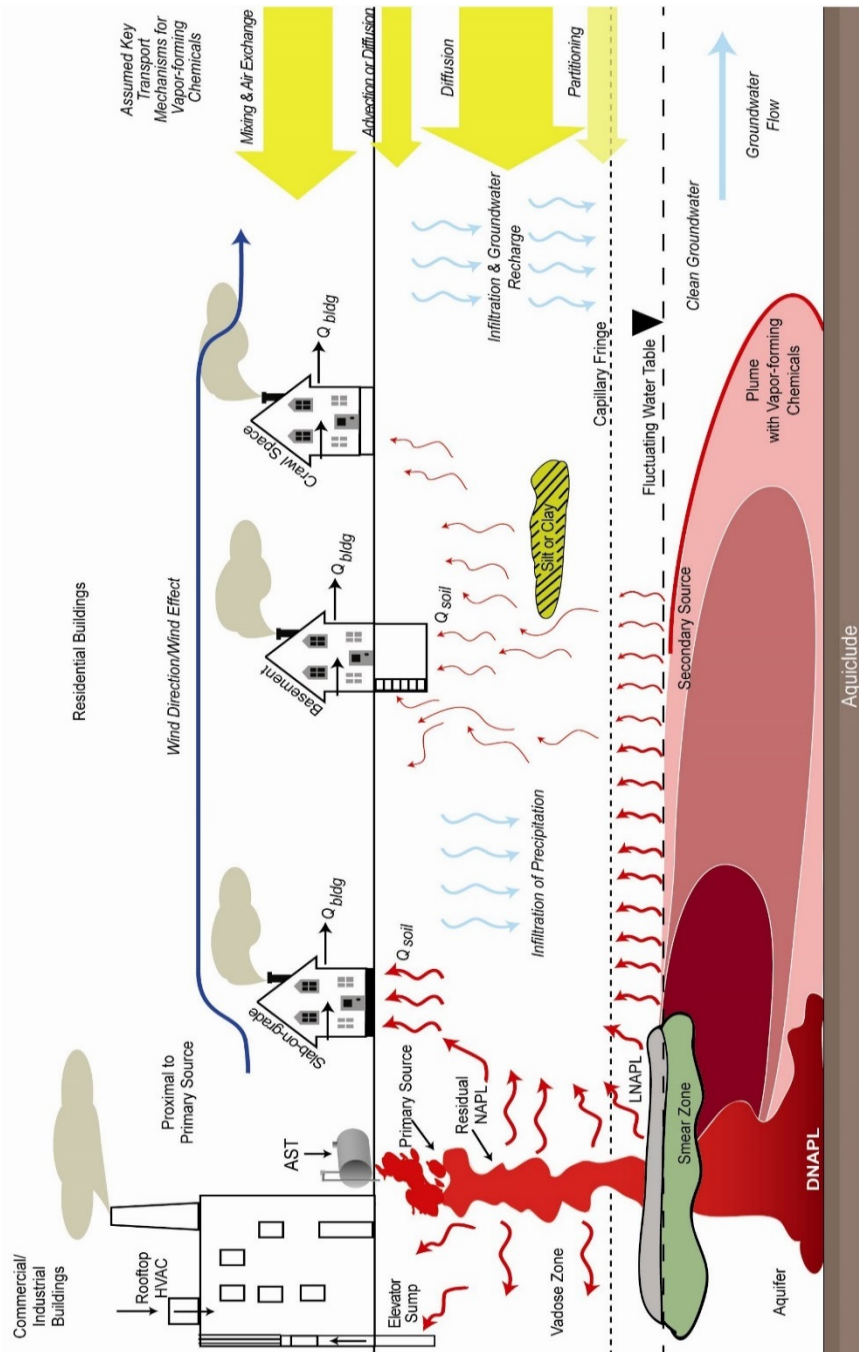
If one (or more) of these conditions is currently absent and is reasonably expected to be absent in the future (e.g., vapor migration is significantly and persistently impeded by natural geologic, hydrologic, or biochemical (e.g., biodegradation) processes and conditions), the vapor intrusion pathway is referred to as “incomplete.”

---

<sup>44</sup> In general, a conceptual site model integrates all lines of site-specific evidence into a three-dimensional conceptualization of site conditions that includes contaminant sources, release mechanisms, vapor migration route(s), and potential receptors. Section 5.4 provides additional information about developing conceptual site models.

<sup>45</sup> A complete vapor intrusion pathway indicates that there is an opportunity for human exposure in the subject building(s), whereas an incomplete pathway would not provide an opportunity for human exposure,

<sup>46</sup> The exposure route of general interest for vapor intrusion is inhalation of toxic vapors present in indoor air. Because breathing is not avoidable for prolonged periods, individuals in occupied buildings are presumed to be exposed by the inhalation route to any hazardous vapors present in indoor air. Hence, the presence of a human exposure route is implied in the fifth condition.



**Figure 2-1 Illustration of Key Elements of the Conceptual Model of Soil Vapor Intrusion**  
 Note:  $Q_{soil}$  represents soil gas entry;  $Q_{bldg}$  represents air exchange.

The first three of these five conditions are further discussed in the next three subsections. Knowledge of potential vapor sources and vapor fate and transport mechanisms is essential for interpreting the data collected during a site-specific investigation of vapor intrusion. Knowledge of the factors that influence the vapor intrusion pathway is also invaluable for identifying, prioritizing, and sequencing data collection activities, which allows a phased and efficient overall investigation plan to be developed. Practitioners are encouraged to refer to quantitative discussions of these subjects, which are provided in *Conceptual Model Scenarios for the Vapor Intrusion Pathway* (EPA 2012b).

The human population of primary interest is comprised of individuals living in, working in, or otherwise occupying a building subject to vapor intrusion. All types of buildings have openings and conduits that render them potentially vulnerable to vapor intrusion. This includes residential buildings (e.g., single-family homes, trailer or 'mobile' homes, multi-unit apartments and condominiums), commercial workplaces (e.g., office buildings, retail establishments), industrial facilities (e.g., manufacturing plants), and educational and recreational buildings (e.g., schools and gyms). Vapor intrusion can occur in buildings with any foundation type (e.g., basement, crawl space, slab-on-grade).

As noted previously, methane and certain other vapor-forming chemicals can also pose explosion hazards in buildings and unoccupied structures,<sup>47</sup> depending upon building-, structure-, and site-specific circumstances. The discussion in the next three sections pertains also to methane and other vapor-forming chemicals that can pose explosion hazards, because similar processes and conditions are involved in explosive vapors migrating towards the interior of buildings or non-occupied structures from the subsurface environment; i.e.,

- 1) A subsurface source of vapor-forming chemicals is present (i.e., in the soil or in groundwater) underneath or near the structure(s) or building(s).
- 2) Vapors form and have a route along which to migrate (be transported) toward the structure(s) or building(s).
- 3) The structure(s) or building(s) is (or are) susceptible to soil gas entry, which means openings exist for the vapors to enter the structure(s) or building(s) and driving 'forces' exist to draw the vapors from the subsurface through the openings into the structure(s) or building(s).

---

<sup>47</sup> For purposes of evaluating potential explosion hazards, non-occupied structures, in addition to buildings, are relevant structures for intrusion and accumulation of vapors.

## 2.1 Subsurface Vapor Sources

The originating (i.e., primary) source(s) of subsurface contamination may include, but are not limited to, leaking tanks (above or below ground), discharges to sewer lines<sup>48</sup>, septic tanks, and floor drains, landfills and other land disposal management units, fire-training areas, spills, discharge areas, and vapor leaks from pressurized tanks and pipelines. The resulting subsurface contamination may be comprised of non-aqueous-phase liquids (NAPLs)<sup>49</sup> (e.g., solvents; petroleum-related products, such as gasoline) and contaminated soil. These are often referred to as the source zone(s). Groundwater and sewer lines<sup>50</sup> flowing through or underneath<sup>51</sup> the source zone(s) can become contaminated and in turn become a (secondary or derivative) subsurface vapor source of contaminant vapors at locations distant from the source zone.

Contaminants in soil, NAPLs, and groundwater can become sources for vapor intrusion if they are likely to volatilize under normal temperature and pressure conditions. Water solubility is also a factor for chemicals in source zones that come into contact with migrating groundwater. Common classes of chemicals of concern for vapor intrusion that exhibit the foregoing characteristics are VOCs, such as tetrachloroethylene (PCE), trichloroethylene (TCE), vinyl chloride, carbon tetrachloride, and benzene, toluene, ethylbenzene and xylenes (collectively, BTEX). Other compounds that are not as volatile as these VOCs (e.g., so-called semi-volatile organic compounds), but that may be cause for concern, include some polycyclic aromatic hydrocarbons (PAHs) (e.g., naphthalene), some polychlorinated biphenyl (PCB) congeners, and elemental mercury, a dense NAPL (DNAPL).<sup>52</sup>

---

<sup>48</sup> Historically, sanitary sewers and septic tanks have been common disposal points for aqueous and chemical wastes from commercial and industrial operations. Contaminated water, non-aqueous phase liquid (NAPL), and VOC vapors can leak from sewer lines through cracks, joints, or breaks. A study of solvent contamination in California arising from dry cleaning operations concluded that discharges to and leakage from sewer lines is an important source of PCE contamination of soil and groundwater: "Where a source investigation has been done in connection with PCE contamination, the ... data strongly indicate that leakage through the sewer lines is the major avenue through which PCE is introduced to the subsurface." (Izzo 1992). In the South Weber neighborhood near the Hill Air Force Base in Utah, sewer lines carrying discharged contaminated groundwater to the municipal treatment system were identified as a source of vapor intrusion in homes [Source: *EnviroNews* - Updating environmental issues and activities at Hill Air Force Base, Utah (March 2011); Currently available on-line at: <http://www.hillrab.org/news.aspx>]

<sup>49</sup> EPA's Contaminated Site Cleanup Information website (<http://www.clu-in.org/>) provides information describing NAPLs that are denser than water (DNAPLs) or less dense than water (LNAPLs), and methods for their detection and remediation in the subsurface environment.

<sup>50</sup> In addition to receiving direct discharges, sewers can be indirect receptacles of subsurface contamination via infiltration of NAPL, soil gas, or contaminated groundwater through cracks in piping and manholes. For example, Vroblesky et al (2011) found that infiltration of contaminated groundwater into sewers and its transport via and exfiltration from sewers caused complex and unanticipated patterns of groundwater contamination at a site in South Carolina.

<sup>51</sup> Figure 2-1 illustrates a NAPL release/source (near the commercial/industrial building on the left) that fully penetrates the vadose zone. A partially penetrating NAPL release/source may also cause groundwater contamination, however, as infiltrating water passes through the source zone and migrates to the groundwater table.

<sup>52</sup> Once volatilized into soil or sewer gas from a subsurface vapor source(s), these less volatile chemicals will migrate under the influence of diffusion and advection (see Section 2.2) as do more volatile chemicals, although there may be chemical-specific differences in their susceptibility to biodegradation in the vadose zone.

Landfill gases, such as methane and hydrogen sulfide, also can be associated with the vapor intrusion pathway for buildings located near current or former landfills or other degrading wastes. These gases are actively produced as a result of anaerobic biodegradation processes. Methane can also be associated with the vapor intrusion pathway for buildings located near degrading petroleum hydrocarbons or fuel-grade ethanol released into the subsurface environment (Ma et al. 2014, 2012; Sihota et al. 2013).

Properties with potential contamination by vapor-forming chemicals can be found in many industrial and commercial areas. These properties include current and former manufacturing and chemical processing plants, warehouses, landfills and other land disposal units, coal gasification plants, chemical handling or transfer facilities and areas (e.g., train yards), dry cleaners, and retail fueling outlets (also known as gas stations). Use, storage, or transport of chemicals at these facilities may have resulted in a release of vapor-forming chemicals to the environment creating the potential for future vapor intrusion issues. In addition to industrial and commercial activities, roadside dumping, pesticide spraying, or even disposal of household chemicals via a septic field may also release volatile chemicals that may eventually migrate to the subsurface environment.

The primary contamination source need not, however, be on the property of interest to pose a vapor intrusion problem.<sup>53</sup> As illustrated in Figure 2-1, the primary source(s) of vapor intrusion (e.g., contaminated soil, or leaked tanks) may be present on a neighboring property or on a property some distance away. Even “greenspace” properties that have not previously been occupied or developed may contain contamination by vapor-forming chemicals due to migrating plumes of contaminated groundwater or migrating soil gases.<sup>54</sup>

In the case of groundwater as a subsurface vapor source for vapor intrusion, the source strength will be influenced by the vertical distribution of contaminant concentrations in the upper reaches (e.g., top foot) of the water table and by seasonal fluctuations in the groundwater table groundmass flux of vapors. If vapor-forming chemicals are not present in the upper reaches (e.g., within the uppermost foot) of the groundwater table (e.g., due to the presence of an overlying zone of clean water from recharge; i.e., “fresh water lens”),<sup>55</sup> vapor transport to the overlying vadose zone will be impeded due to the slower diffusion of volatile chemicals in water

---

<sup>53</sup> Depending on the geology and amount and form of contamination in the source zone(s), contaminated groundwater plumes can be long and narrow and can flow beneath a property located a mile or more away from the primary source. Soil gas plumes tend to extend in both lateral directions and can be larger in lateral extent relative to groundwater plumes.

<sup>54</sup> See Section 6.2.1 for further discussion on which buildings and non-occupied structures are considered “near” for purposes of a preliminary analysis.

<sup>55</sup> Infiltrating precipitation is important in recharging aquifers with fresh water, as well as in wetting vadose zone soils. At locations distant from “source zones,” infiltrated water that reaches the upper surface of a plume of contaminated groundwater (i.e., recharges groundwater) in an unconfined aquifer will tend to dilute concentrations of vapor-forming chemicals and may form a lens of relatively “clean” water at the groundwater table, which overlies the plume. Because diffusion of dissolved-phase volatile chemicals will tend to control the mass transfer of vapors into the soil gas at the groundwater table, the presence of a lens of clean water as little as a foot in thickness overlying a plume may be sufficient to impede vapor flux to the vadose zone (McAlary et al. 2011). This condition is less likely to occur where fluctuations of the groundwater table are large, relative to local recharge, and would not generally be expected in arid climates.

than in soil gas. For this reason, Figure 2-1 does not show vapors emanating from the leading (i.e., right-most) edge of the plume.

If the vapor-forming chemicals are present in the upper reaches of the groundwater table (i.e., volatile chemicals are in the uppermost reaches of an unconfined – “water table” – aquifer), fluctuations in the water table will tend to transport the volatile chemicals upward (during periods of rising water table) or expose impacted water above the water table to soil gas (during periods of falling water table). The latter will facilitate the episodic formation of vapors in the vadose zone. Rising water tables also will bring the vapor source closer to the building(s).

## 2.2 Subsurface Vapor Migration

At many sites, the subsurface vapor source (e.g., in soil or groundwater) is not in contact with the bottom of the subject building. Under these circumstances, vapors emanating from the source medium enter the pore space around and between the subsurface soil particles in the soil column above the groundwater table, which is called the unsaturated soil zone or vadose zone. If the subsurface vapor source is in the vadose zone, the vapors have the potential to migrate radially in all directions from the source via diffusion (i.e., upward toward the atmosphere, laterally outward, and downward toward the water table; downward migration may eventually lead to groundwater contamination). If the subsurface vapor source is in the uppermost zone of groundwater, the vapors have the potential to migrate upwards toward the atmosphere via diffusion. Figure 2-1 illustrates these conditions and this process.

Regardless of source type, soil gas concentrations emanating from a subsurface vapor source generally attenuate, or decrease, as the volatile chemicals move from the source through the soil and into indoor air. If and when soil vapor monitoring data at a given site are not consistent with this trend, the conceptual site model may be incomplete (e.g., additional, unrecognized sources or a preferential migration route(s) may exist at the site) and/or bias or error may have been imparted by the sampling and analysis techniques.

Diffusion, which is caused by the random motion of molecules, affects the distribution of soil vapors when there are spatial differences in chemical concentrations in the soil gas. The net direction of diffusive transport is toward the direction of lower concentrations.

Advection occurs in the vadose zone when there is bulk movement of soil gas induced by spatial differences in soil gas pressure. The direction of advective vapor transport is always toward the direction of lower air pressure. Advection is generally expected to occur in the vicinity of buildings, because differences in temperature between the building interior and the subsurface environment or the operation of combustion units or fans within the building can create driving forces for soil gas entry (See Section 2.3). Advection of soil gas may also occur:

- near the ground surface due to fluctuations in barometric (atmospheric) pressure, which can either release soil gas into the atmosphere (Clements and Wilkening 1974) or

introduce ambient air into the subsurface environment (the latter process may be important in oxygenating surface soil horizons);<sup>56</sup>

- wherever methane generation from anaerobic degradation is sufficiently high (e.g., near some landfills, some locations with degrading fuels).

Advection may be hindered where extensive surface barriers, such as asphalt, concrete, or frozen soil are present.

Vapors also can migrate via advection (and diffusion) along a preferential subsurface pathway, such as a utility corridor or more porous zones of soil or rock, or beneath surface barriers that limit the direction(s) of vapor migration, such as frozen ground or asphalt.<sup>57</sup>

Vapor migration in the vadose zone can be impeded by several factors, including high soil moisture, low-permeability (generally fine-grained) soil, and biodegradation:

- High moisture levels in the vadose zone can significantly reduce the effective rate of diffusive transport, owing to the substantially smaller diffusion coefficient of vapor-forming chemicals in water compared to air. Where ground covers, such as asphalt or concrete, are absent, soil cores taken external to building structures can reasonably be expected to show greater soil moisture than underneath buildings (Tillman and Weaver 2007), particularly after episodes of precipitation and infiltration. Fluctuations in the elevation of the groundwater table can also contribute to temporal changes in soil moisture profiles, in addition to changing the thickness of the vadose zone.
- A low-permeability layer in the vadose zone, particularly one with high moisture content or perched water, may impede or prevent upward migration of vapors from deeper sources in the vadose zone. Figure 2-1 illustrates partial impedence due to a silty or clay layer of limited lateral extent.<sup>58</sup> In some cases, soil or rock can impose sufficient resistance to vapor migration to make the vapor intrusion pathway insignificant, because low-permeability layers are laterally extensive over distances that are large compared to the size of the building(s) or the extent of subsurface contamination with vapor-forming chemicals.

---

<sup>56</sup> Under certain conditions, such as periods during which indoor-outdoor pressure differences are small, atmospheric pressure fluctuations may contribute to the vapor flux into a building (Robinson and Sextro, 1997).

<sup>57</sup> Whether the subsurface vapor source is contaminated soil or groundwater, soil gas concentrations emanating from a subsurface source generally attenuate, or decrease, as the vapors move from the source through the soil and into indoor air due to diffusion and advection and are subject to any degradation. If and when soil vapor monitoring data at a given site are not consistent with this trend, the possible existence of a preferential migration route(s) warrants consideration. Sewer lines also warrant consideration as potential sources of vapors, as well as conduits for preferential (e.g., unattenuated) transport of vapors towards buildings. Preferential migration routes are discussed further throughout this Technical Guide, including in Sections 5.4, 6.3.2, and 6.5.2.

<sup>58</sup> Low-permeability layer(s) overlying contaminated groundwater (i.e., "aquicludes") can, likewise, impede the flux of vapors from the contaminated plume to the vadose zone. The aquiclude shown at the base of Figure 2-1 would not impede the flux of vapors from the contaminated plume to the vadose zone, however, because the aquiclude is below both. The aquiclude would impede vapor flux from any additional contaminated plume located below it.

- Some chemicals (e.g., benzene, methane, and other petroleum hydrocarbons; vinyl chloride (Patterson et al. 2013) and some other chlorinated hydrocarbons) may experience reductions in their soil gas concentrations due to biodegradation in the vadose zone under certain conditions. Depending upon the potential for oxygen to migrate into the subsurface and underneath buildings from the ambient air, biodegradation may be anaerobic or aerobic. The rate of biodegradation *in situ* will be chemical-specific (i.e., chemicals have different degradation rates even within a similar microbial environment), will be site-specific (i.e., the microbial environment will depend upon soil moisture, nutrient and oxygen levels, and the chemical mixture,<sup>59</sup> among other factors (Holden and Fierer 2005)), and may be location-specific (i.e., the microbial environment can change over time and space due to variations in soil moisture,<sup>60</sup> nutrient and oxygen<sup>61</sup> levels). In some cases, biodegradation in the vadose zone can impede vapor migration significantly.

Demonstrating the extent, if any, to which these processes act as a barrier to vapor transport at specific sites may entail intensive testing or investigative methods that are very different from the sampling and analysis techniques for indoor air and soil gas (see, for example, Sections 6.3.2 and 6.4). Where and when it occurs, biodegradation may result in the formation of by-products that are potentially hazardous (e.g., methane from ethanol, vinyl chloride from PCE or TCE).

The distribution and magnitude of soil gas concentrations immediately beneath a building are expected to reflect the interplay between vapor transport toward the building (via diffusion and advection) in the vadose zone and vapor withdrawal due to soil gas entry into the building (in the case where the building is under-pressurized), which may be spatially and temporally variable (Section 2.3). Likewise, soil vapor may become contaminated as a result of over-pressurized buildings forcing contaminated indoor air through openings in the foundation into nearby soil.

### 2.3 Openings and Driving Forces for Soil Gas Entry into Buildings

Hazardous vapors in the vadose zone may eventually enter buildings as a component of a gas by migrating through cracks, seams, interstices, and gaps in basement floors, walls, or foundations (“adventitious openings”) or through intentional openings, such as perforations due to utility conduits and sump pits. Figure 2-2 illustrates some of these types of openings. Buildings can be expected to vary, even within a single community, in the amount of opening

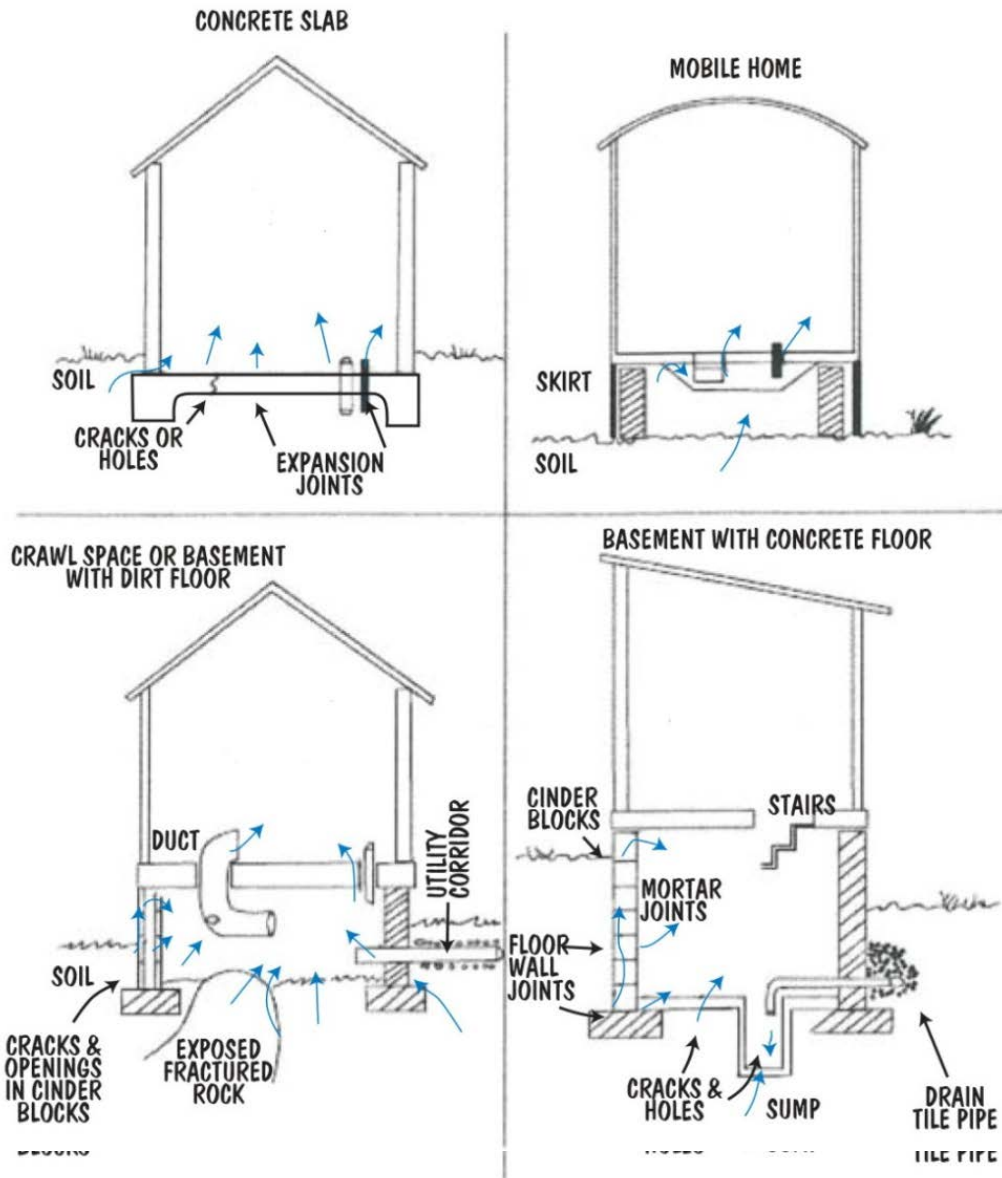
---

<sup>59</sup> For example, aerobic biodegradation of benzene may be impeded by the presence of methane, due to competition for oxygen by methane-oxidizing (“methanotrophic”) bacteria, depending upon site-specific conditions (Ma et al. 2012).

<sup>60</sup> Moisture plays a particularly important role for microorganisms in the vadose zone. Microbial growth and activity can decrease rapidly with depth, coincident with the soil moisture profile, and increase again in the capillary fringe (Holden and Fierer 2005).

<sup>61</sup> Site-specific infrastructure and soil conditions, climate, and other factors will determine the extent to which oxygen levels underneath a building will be different compared to locations outside the building footprint. In addition to buildings, surface covers, such as asphalt or concrete, can impede oxygenation of the vadose zone, relative to the case where the ground surface is in contact with the atmosphere, all other factors being equal.





**Figure 2-2 Illustration of Potential Openings in Various Building Types**  
Note: Blue arrows represent soil gas migration or entry. Source: EPA (2008)

area available for soil gas entry; for example, buildings with deteriorating basements and foundations or dirt floors are more susceptible to soil gas entry.

As mentioned in Section 2.2, advection in the vadose zone can arise in the vicinity of buildings whenever there is a difference between the air pressure within a building and the subsurface environment. The air pressure within a building can be lower than in the subsurface due to:

- Temperature differences between indoor and subsurface locations (e.g., the winter-time “stack effect,” when buildings are commonly heated, leading to convection cells driven by heated air that rises to upper levels and leaks through roofs and upper-floor windows).
- The operation of mechanical devices, such as exhaust fans for ventilation, air conditioners, and clothes dryers, with vents to the outdoors.
- The operation of fireplaces that vent combustion (exhaust) gases to the outdoors.
- The operation of furnaces in basements of centrally heated buildings, which can incrementally depressurize the basement (EPA 1993a).
- Wind load on the building walls.<sup>62</sup>

Even small pressure differences may cause advective flow of soil gas into or out of the building through pores, cracks, or openings in the building floor or basement walls<sup>63</sup> or gas present in drain lines, sumps, and sewer lines that do not have adequate vapor traps.<sup>64</sup>

---

<sup>62</sup> The wind effect is caused by differences in building pressure on a building's surfaces. The outdoor air pressure will be higher on the windward side of the building, than on the leeward side, as ambient air flows around the building. The net effect of this pressure difference will vary from building to building, depending upon the location of the primary openings for soil gas entry (and the primary opening for air infiltration through the building envelope –see Section 2.4) (EPA 1993a, Section 2.3 therein).

<sup>63</sup> As a result of the construction of foundation walls and floor slabs, a perimeter crack (i.e., space between the floor slab and walls) may be created and serve as an entry location for soil vapors. This perimeter crack is often obscured by wall coverings, and may not be accessible for inspection or direct testing. Vapors have been observed to migrate through what appears to be intact concrete floors and walls, which may, in fact, have small unobserved fractures or porous areas from improper curing. In addition, conduits may be present that facilitate soil gas entry into buildings. These conduits may include utility (e.g., sewer, water, or electrical) penetrations and floor drains

<sup>64</sup> Where sewers or other conduits contain volatile contaminants, lateral lines connecting buildings to these conduits may facilitate vapor intrusion into indoor air. Although floor drains are designed to allow water to drain away from the building, they are usually not designed or constructed to eliminate gas entry. At a test house in Indianapolis, elevated levels of PCE and chloroform were found in gas in a laundry drain line, which was suspected of serving as a source of vapors found in indoor air (EPA 2012f). Although building construction codes and toilet designs are intended to prevent sewer gas from entering homes, inadequate maintenance (e.g., plumbing fixture seals) can result in loss of the intended protection. Pennell et al (2013), for example, found sewer gas entry to be a significant source of PCE in indoor air at a home in Massachusetts. In addition, sewer gas was a suspected source of benzene in indoor air in many buildings near a gasoline spill site in Hazleton, Pennsylvania ([www.epa.gov/req3hw/nd/npl/PA0001409671.htm](http://www.epa.gov/req3hw/nd/npl/PA0001409671.htm)), where sewer vent traps were subsequently installed to mitigate intrusion of gasoline vapors into homes.

To date, most analytical and computational models of vapor intrusion have been predicated on the assumption that residences and other small buildings experience a constant under-pressurization (i.e., lower pressure in the building than in the subsurface), which fosters vapor intrusion. Whereas this assumption facilitates analyses and may be reasonable for some purposes (see, for example, Section 2.5), it is highly idealized. To illustrate: fluctuations in subslab-to-building pressure difference (and, hence, soil gas entry rates) over time can be reasonably expected due to:

- diurnal (daily) and seasonal changes in the temperature of ambient air, whereas indoor temperatures may be more stable, particularly during periods when mechanical heating and cooling systems are in use;
- changes in ambient air pressure;
- non-instantaneous response (i.e., lag or delay in response) of subsurface soil gas to changes in ambient air pressure (EPA 1993a, Section 2.3 therein), particularly where low-permeability soil is in direct contact with a building foundation (e.g., basement) below the ground surface;<sup>65</sup>
- changes in wind direction and speed; and
- intermittent operation of mechanical ventilation systems and combustion devices that vent exhaust gases to the outside.

Theoretically, these processes and variables suggest that soil gas entry rates can be expected:

- to vary over different time scales (e.g., within an day, and between seasons);
- to differ geographically due to differences in ambient air temperature, pressure, wind, and building conditions (e.g., leakage area and its distribution over the building envelope); and
- to be discontinuous over some time periods.

---

<sup>65</sup> On the other hand, where granular fill is present underneath a building, there is potential for preferential soil gas flow through the fill, especially in locations where the gas permeability of the surrounding soil is low. Where granular materials have differentially settled, air voids (also highly permeable to soil gas flow) may form beneath the foundation. Utility penetrations and other conduits may be connected to the granular fill, accentuating the potential pathway for soil gas entry into a building. Adding to the complexity, pressure differentials caused by wind flows conceivably could create a cross-flow through granular fill underneath the foundation, which may episodically dilute vapor concentrations (and oxygenate soil gas) in the building vicinity.

## 2.4 Air Exchange and Mixing

Air exchange refers to the flows into and out of a building, which are generally in balance, and is composed of three processes:

- 1) infiltration—air leakage through random cracks, interstices, and other unintentional openings in the building envelope;
- 2) natural ventilation—airflows through open windows, doors, and other designed (intentional) openings in the building envelope; and
- 3) mechanical ventilation—air movement controlled and driven by fans.

For the vapor intrusion exposure scenario, air exchange by each of these processes will generally tend to mitigate the effects of vapor intrusion (i.e., reduce indoor air concentrations) via dilution, while air inflows will also transport indoors any vapor-forming chemicals in ambient air (see Section 2.7).<sup>66</sup>

The air exchange rate is conventionally defined as the ratio of the airflow rate (e.g., cubic meters per second) to the building volume (e.g., cubic meters) and is generally expressed in terms of exchanges per hour (i.e., overall units of  $\text{hour}^{-1}$ ). Values for residential air exchange rates are typically on the order of approximately 0.18 to 1.26 air changes per hour (ACH) (EPA 2011b, see Table 19-24 therein, 10<sup>th</sup> and 90<sup>th</sup> percentiles).<sup>67,68</sup> Values for non-residential buildings are highly-dependent upon building use and can range widely (on the order of approximately 0.3 to 4.1 ACH) (EPA 2011b, see Table 19-27 therein, 10<sup>th</sup> and 90<sup>th</sup> percentiles).

---

<sup>66</sup> The potential diluting effect of air exchange arises when ambient air has negligible presence of the volatile chemicals found in site-related contamination in the subsurface environment. In some situations, site-related contamination has the potential to impact ambient air with the same vapor-forming chemicals that pose a threat from vapor intrusion. For example, contamination of shallow soil or groundwater may release site-related vapor-forming chemicals to ambient air. In such situations, air exchange would contribute to the presence of site-related contamination in indoor air, rather than only dilute any impacts from vapor intrusion.

<sup>67</sup> EPA's Office of Research and Development evaluated eight studies of air exchange rate for residential buildings and selected a 1995 EPA study as the basis for recommending values for risk assessment (EPA 2011b, Table 19-24). The key study analyzed almost 3,000 time-averaged measurements of exchange rate in occupied homes in the United States, which were generally obtained using a tracer-release method. Median values ranged from 0.35  $\text{hour}^{-1}$  in the mid-western region to 0.49  $\text{hour}^{-1}$  in the northeast and southern regions. Tenth percentile values ranged from 0.16  $\text{hour}^{-1}$  in the mid-western and southern regions of the U.S. to 0.23  $\text{hour}^{-1}$  in the northeast region. Regional differences in exchange rate reflect differences in weather (e.g., temperature and wind speed), prevailing building conditions (e.g., house 'leakiness'), and the time periods (e.g., season) in which measurements were made.

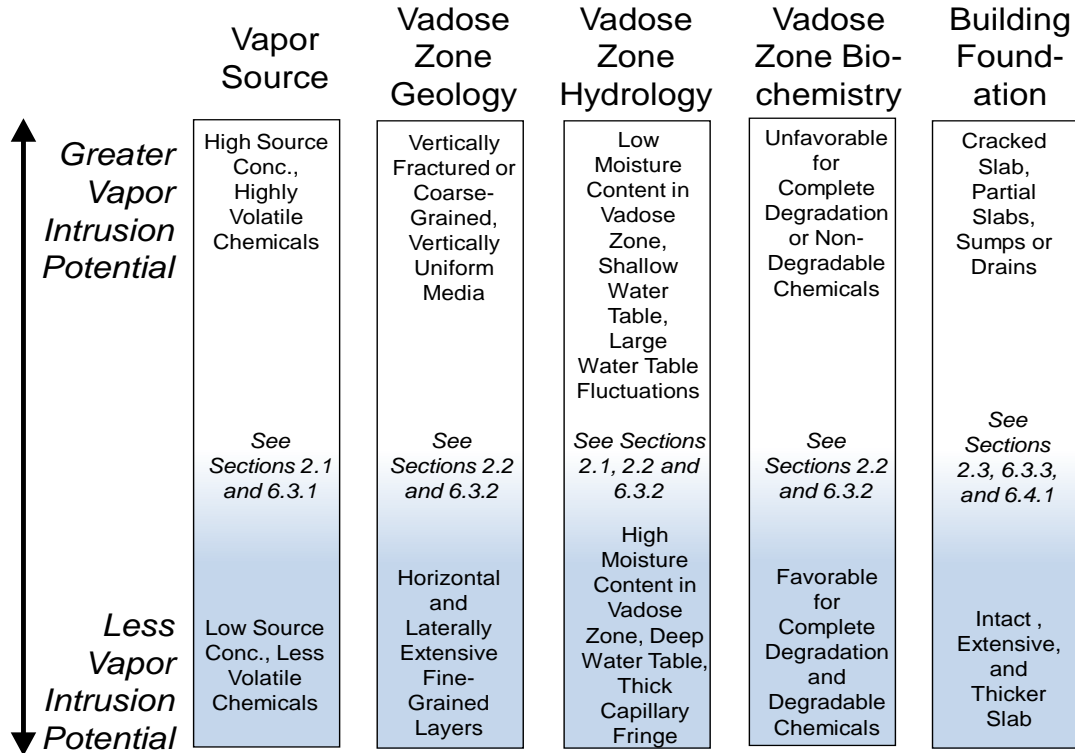
<sup>68</sup> EPA's Office of Research and Development (EPA 2011b, Section 19.5.1.2.7) also summarized a study that conducted approximately 500 indoor-outdoor air exchange rate (AER) calculations based on residences in three urban locations (metropolitan Elizabeth, NJ; Houston, TX; and Los Angeles, CA). This study highlights how climate and season can influence air exchange rate. In Texas, the measured AERs were lower in the summer cooling season (median = 0.37 ACH) than in the winter heating season (median = 0.63 ACH), likely because windows were closed while air conditioners were in use. The measured AERs in California were higher in summer (median = 1.13 ACH) than in winter (median = 0.61 ACH), because summers in Los Angeles County are less humid than NJ or TX and residents are more likely to utilize natural ventilation through open windows and screened doors. In New Jersey, air exchange rates in the heating and cooling seasons were similar.

To date, most analytical and computational models of vapor intrusion have been predicated on the assumption that residences and other small buildings are well mixed spaces throughout which concentrations of vapor-forming chemicals are uniform. Whereas this assumption facilitates analyses and may be reasonable for some purposes (see Section 2.5), it is highly idealized. To illustrate: airflow within a building (i.e., inter-zonal airflow) can be impeded by doors, walls, and other partitions that separate rooms and other building areas. Whereas airflows within a building can be facilitated by mechanical means, spatial variation of temperature and humidity suggest that air mixing is not necessarily complete even in buildings that benefit from centralized systems for heating, air condition, and ventilation. Furthermore, many residences do not have such mechanical systems. Therefore, buildings subject to vapor intrusion may exhibit differences in concentration of vapor-forming chemicals among building areas (e.g., rooms) as a result of the differential proximity to openings for soil gas entry (see Section 2.3) and openings for air leakage and ventilation and the magnitude and balance of inter-zonal airflows. For example, rooms with perforations through the foundation (e.g., bathrooms or utility rooms) may have greater concentrations of vapor-forming chemicals in air compared to rooms that do not. Generally, basements can reasonably be expected to exhibit greater concentrations of vapor-forming chemicals than upper occupied levels.

Buildings constructed over a crawl space with a dirt floor may benefit from the dilution of soil gas by any ventilation of crawl space air, but would not have the impedance to vapor intrusion that concrete slabs can provide. Trailers enclosed at the bottom by a skirt are expected to have greater potential for vapor intrusion than would non-enclosed trailers. Wind movement between the ground surface and the bottom of the non-enclosed trailer would tend to minimize vapor buildup and associated potential for vapor flux into the building. Similarly, the existence of underground parking for a multi-story building (or other modifications to the foundation that enhance subsurface ventilation) would tend to minimize the potential for vapor intrusion.

## 2.5 Conceptual Model Scenarios

Based upon the foregoing conceptual model, numerous factors can influence the potential indoor air concentration arising from vapor intrusion. Some of these significant factors are illustrated in Figure 2-3.



**Figure 2-3 Some Factors That Affect Vapor Intrusion**

The document *Conceptual Model Scenarios for the Vapor Intrusion Pathway* (EPA 2012b) provides simplified simulation examples<sup>69</sup> to illustrate graphically how several of the subsurface and building-specific factors work together to determine the distribution of volatile contaminants in the subsurface and the indoor air concentration relative to a source concentration. The conceptual model scenarios document offers insights into the factors influencing the vapor intrusion pathway. It provides a theoretical framework with which to draw inferences about and better understand the complex vapor fate and transport conditions typically encountered at actual, non-idealized contaminated sites. The following general observations can be made from these simplified simulation examples, and may be useful when considering the vapor intrusion pathway at a particular site:

- The horizontal and vertical distance over which vapors may migrate in the subsurface depends on the source concentration, source depth, soil matrix properties (e.g., porosity and moisture content), and time since the contaminant release to the environment occurred. Months or years of volatilization and vapor migration may be required to fully develop vapor distributions in the vadose zone at sites with deep vapor sources or with impedances to vapor migration arising from hydrologic or geologic conditions.
- Vapor concentrations, including oxygen, in the vadose zone (i.e., soil gas concentrations) may not be uniform in sub-slab soil gas or in soil gas at similar depths exterior to the building of interest. Therefore, soil gas concentrations at exterior locations (i.e., outside a building's footprint) may be substantially different from the concentration underneath the building (e.g., the sub-slab concentration), depending on site-specific conditions and the location and depth of the exterior soil gas sample.
- Simulations assuming an idealized, constructed ground cover suggest that shallow soil gas concentrations can be greater under low-permeability ground covers (e.g., asphalt) than under soil open to the atmosphere.
- The soil gas distribution beneath a building is not the only factor that determines the indoor air concentration. The indoor air concentration is also influenced by building conditions, including the presence of openings (e.g., cracks, utility penetrations) in the foundation, building pressurization, and the air exchange rate.
- Advective flow into buildings, which is presumed to occur predominantly near cracks and openings in the foundation slab, may affect the distribution of vapor-forming chemicals directly beneath the structure. Heterogeneities in the permeability of geologic materials and backfill, along with wind effects and building and atmospheric pressure temporal variation, may also contribute to the spatial and temporal variability of vapor concentrations in sub-slab soil gas and indoor air.

---

<sup>69</sup> Two important simplifications are the assumptions of constant values for the driving force for vapor intrusion (i.e., subslab to indoor air pressure difference) and air exchange rate, whereas time-variable values are reasonably expected as a result of changing weather and other conditions (as summarized in Sections 2.3 and 2.4, respectively).

- Subsurface heterogeneities in site geology, such as layering and moisture content, can influence the extent and rate of vapor migration from a contaminant source towards overlying or adjacent buildings.
- The soil gas distribution of aerobically biodegradable chemicals (e.g., BTEX) can be significantly different than that of other chemicals that are not biodegradable (i.e., are recalcitrant) in similar settings. Specifically, the soil gas concentrations of aerobically biodegradable chemicals exhibit greater attenuation than those of recalcitrant chemicals when the subsurface availability of oxygen is adequate.

## 2.6 Variability in Exposure Levels

Given the foregoing conceptual model of vapor intrusion and summary of modeled scenarios (EPA 2012b), the degree to which vapor intrusion is a pathway of concern can vary widely from site to site and from building to building within a site. Adding to the complexity, theoretical considerations (i.e., soil gas entry rates, air exchange rates, interior compartmentalization and inter-zonal airflows) suggest that indoor air concentrations arising from vapor intrusion can be expected to vary over time and within a building. Field observations and measurements demonstrate that indoor air concentrations can exhibit significant temporal variation within a day and between days and seasons in an individual residential building (EPA 2012a; Holton et al. 2013ab).

## 2.7 Consideration of Indoor and Outdoor Sources of VOCs

Indoor air in many buildings will contain detectable levels of a number of vapor-forming chemicals whether or not the building overlies a subsurface source of vapors (EPA 2011a), because indoor air can be impacted by a variety of indoor and outdoor sources. Indoor sources of volatile contaminants include the use and storage of consumer products (e.g., cleaners, air fresheners, aerosols, mothballs, scented candles, insect repellants, or other household products), combustion processes (e.g., smoking, cooking, and home heating), occupant activities (e.g., craft hobbies, home improvements, automotive repairs), and releases from interior building materials (e.g., carpets, insulation, paint, and wood-finishing products). Outdoor sources of volatile chemicals may arise due to releases from nearby sources such as industrial facilities, vehicles, yard maintenance equipment, fuel storage tanks, and paint or pesticide applications; regional sources such as air emissions from regional industry, vehicle exhaust, agricultural activities, and fires; or global sources, such as distant air emissions. The outdoor air surrounding a building is referred to as “ambient air” throughout this Technical Guide.

The contribution of indoor and outdoor sources of vapors (or both) to indoor air concentrations, which do not arise from site-related contamination,<sup>70</sup> is referred to as “background” throughout this Technical Guide (see, for example, Sections 2.7, 6.3.5, and 7.4.2 and the Glossary). In

---

<sup>70</sup> In some situations, site-related contamination has the potential to impact indoor or ambient air (EPA 1993c) with the same vapor-forming chemicals that pose a threat from vapor intrusion. For example, contaminated groundwater in building sumps or intruding into the building via groundwater seepage could provide an indoor source of site-related contamination. Contamination of shallow soil or groundwater may also release site-related vapor-forming chemicals to ambient air. In such situations, neither of these sources of indoor air contamination would be considered ‘background.’



some buildings, “background” sources by themselves can cause building occupants and visitors to experience significant exposures to vapor-forming chemicals.

In contrast to “background” concentrations in soil arising from naturally occurring minerals, “background” concentrations in indoor air often are not uniform in time. For example, concentrations of vapor-forming chemicals in ambient air may exhibit temporal variation over several time scales (e.g., daily, seasonal, longer term) and spatial differences across urban, suburban, and rural land use areas, reflecting differences in emission sources and rates and environmental factors that transport, disperse, and remove these pollutants (Jia et al. 2012 and citations therein). Concentrations of vapor-forming chemicals arising in indoor air in residential buildings due to indoor sources have been observed to depend upon season and other factors. Available studies suggest complex (e.g., patchy) spatial patterns in exposure concentration, which has led some researchers to refer to “microplumes” in the indoor air environment (McBride et al., 1999 and citations therein).

### 3.0 OVERVIEW OF THIS VAPOR INTRUSION TECHNICAL GUIDE

This section provides an overview of this Technical Guide and the general recommended framework for vapor intrusion assessment and response action, which is illustrated in Figure 3-1. This section opens with a description of subsurface contaminants that have the greatest potential to pose a health concern via vapor intrusion, based upon their volatility and potential hazards.

#### 3.1 Contaminants of Potential Concern

Several physicochemical criteria may be considered for defining and screening for volatility.<sup>71</sup> For purposes of this Technical Guide, a chemical generally is considered to be “volatile” if:

- 1) Vapor pressure is greater than 1 millimeter of mercury (mm Hg), or
- 2) Henry’s law constant (ratio of a chemical’s vapor pressure in air to its solubility in water) is greater than  $10^{-5}$  atmosphere-meter cubed per mole ( $\text{atm m}^3 \text{mol}^{-1}$ ) (EPA 1991b, Section 3.1.1; EPA 2002c, Appendix D).

Various other criteria may be considered for identifying when volatile chemicals are present at levels of potential health concern. For purposes of this Technical Guide, a volatile chemical generally is considered to be “potentially toxic” via vapor intrusion if:

- 1) the vapor concentration of the pure component exceeds the indoor air target risk level, when the subsurface vapor source is in soil, or
- 2) the saturated vapor concentration exceeds the target indoor air risk level, when the subsurface vapor source is in groundwater.

Each of the chemicals with one or more toxicity values used to derive Regional Screening Levels ([http://www.epa.gov/reg3hwmd/risk/human/rb-concentration\\_table/Generic\\_Tables/index.htm](http://www.epa.gov/reg3hwmd/risk/human/rb-concentration_table/Generic_Tables/index.htm)) were evaluated for volatility and toxicity, according to the foregoing recommended criteria. These criteria do not include a consideration of whether these chemicals are regulated pursuant to CERCLA, as amended, or RCRA, as amended. The universe of chemicals evaluated and the results of the evaluation are provided in EPA’s on-line VISL Calculator (EPA 2015a), which is described further in Sections 1.4.1 and 6.5.2 of this Technical Guide.

Chemicals which satisfy the foregoing screening criteria for volatility and toxicity are designated as “vapor-forming chemicals” for purposes of this Technical Guide. In addition:

---

<sup>71</sup> In chemistry and physics, volatility refers to the tendency of a substance to form vapors, which are molecules in a gaseous state, and escape from a liquid or solid. Volatility is directly related to a substance’s vapor pressure and Henry’s law constant. EPA (1991b) also cites molecular weight as a necessary criterion for assessing volatility. Molecular weight is not retained for this Technical Guide as a volatility criterion, because it is a relatively weak predictor of volatility.

- cis-1,2-dichloroethylene, a volatile chemical that lacks sufficient toxicity information (to apply the toxicity criteria above), is identified as a vapor-forming chemical due to its potential use as an indicator of vapor intrusion when it is present as a subsurface contaminant;<sup>72</sup>
- methane is identified as a vapor-forming chemical due to its potential to pose an explosion hazard and to be formed via anaerobic biodegradation processes in the subsurface environment;<sup>73</sup> and
- radon is identified as a vapor-forming chemical when it arises from uranium- or radium-bearing solid wastes in the subsurface.<sup>74</sup>

Chemicals that meet these recommended screening criteria are referred hereafter in this Technical Guide as “vapor-forming chemicals.” EPA recommends that these chemicals be evaluated during vapor intrusion assessments, when they are present as subsurface contaminants due to a site-related release(s). EPA recommends that chemical analyses be limited to those vapor-forming chemicals known or reasonably expected to be present in the subsurface environment due to a site-related release(s). The list of vapor-forming substances warranting consideration for potential vapor intrusion may be modified in the future.<sup>75</sup>

### 3.2 Vapor Intrusion Assessment

The approach for assessing vapor intrusion will vary from site to site, due to site-specific factors. For example, the information available for evaluating vapor intrusion potential will vary depending upon when vapor intrusion is first considered during a site’s investigation-and-cleanup life cycle. Many sites can be evaluated for potential vapor intrusion during the normal course of an initial site assessment. Examples include brownfield sites that are intended for redevelopment and buildings where chemical odors have been reported. The data available for evaluating vapor intrusion may be very limited at the outset for these situations. At the other end of the investigation and cleanup life cycle, certain sites with long- term cleanups underway for contaminated groundwater may be evaluated for vapor intrusion during periodic reviews, if any,

---

<sup>72</sup> EPA (2011a) and DoN (2011a) report that cis-1,2-dichloroethylene (cis-1,2-DCE) is “rarely detected in background indoor air.” When they are subsurface contaminants, volatile chemicals, such as cis-1,2-DCE, that are rarely or never present in indoor sources can be inferred to arise in indoor air via vapor intrusion “without further explanation” (DoN 2011a). Brenner (2010), for example, employed this principle to identify buildings susceptible to vapor intrusion and to diagnose the relative contributions of vapor intrusion and infiltration to indoor air concentrations.

<sup>73</sup> As noted previously, methane in soil gas may produce two other undesirable consequences: (1) it can exacerbate migration and intrusion of other vapors if it is generated at rates sufficient to foster advective flow of soil gas (see Section 2.3); and (2) its biodegradation in the vadose zone can reduce the oxygen available for biodegradation of other hydrocarbons (Ma et al. 2012).

<sup>74</sup> Radon emanating from natural geological materials may also affect indoor air quality in occupied buildings, but is not a subject of this Technical Guide. For more information about radon emanating from natural geological materials, see: <http://www.epa.gov/radon/index.html>.

<sup>75</sup> For example, inhalation toxicity values for additional volatile chemicals may become available in the future.

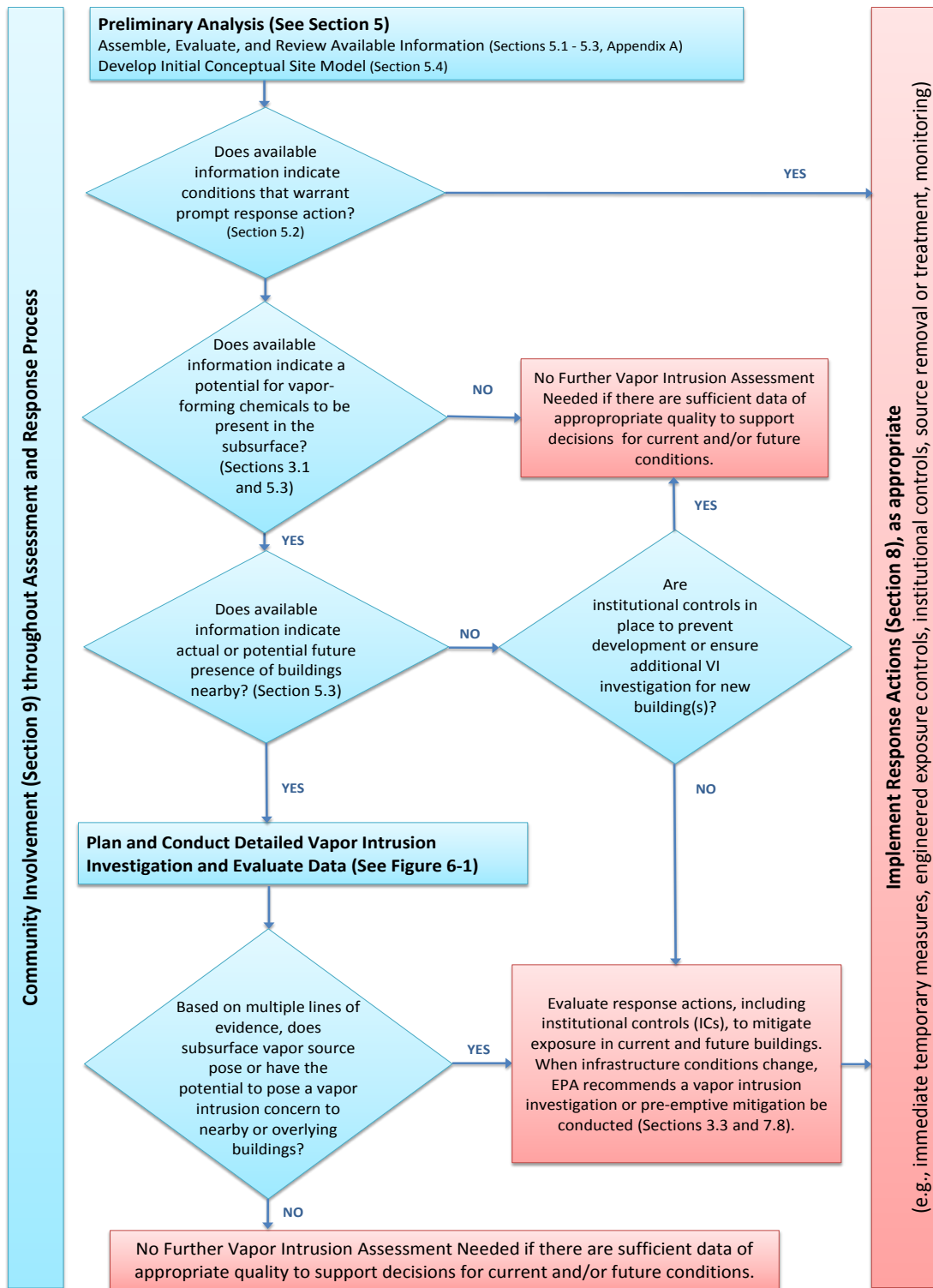


Figure 3-1 Overview of Recommended Framework for Vapor Intrusion Assessment and Response Action

of remedy performance and groundwater monitoring data.<sup>76</sup> In such situations, detailed information about the nature and extent of subsurface contamination and the relevant hydrogeologic conditions may already exist. In addition, there are different scenarios for vapor intrusion (EPA 2012b), depending on characteristics of the source (e.g., types, chemicals of concern, mass, distribution, and distance from building(s)), subsurface conditions and vapor migration routes (e.g., soil types and layering, existence of preferential migration routes due to geology or infrastructure, and existence of any impediments to vapor migration), building susceptibility (e.g., age, design, construction, condition), lifestyle factors (e.g., keeping windows open or closed), and regional climate. For these reasons, every site (and every building) will not warrant the same approach to or intensity of assessment for vapor intrusion. This Technical Guide, therefore, recommends a framework for planning and conducting vapor intrusion investigations, rather than a prescriptive step-by-step approach to be applied at each and every site.

Broadly speaking, two general levels of vapor intrusion assessments can be distinguished:

- 1) A preliminary analysis utilizes available and readily ascertainable information to develop an *initial* understanding of the potential for human health risk that are or may be posed by vapor intrusion, which would typically be performed as part of an initial site assessment. The recommended information, approaches, and practices for conducting a preliminary analysis and its potential outcomes are described in Section 5.0.
- 2) A detailed investigation is generally recommended when the preliminary analysis indicates that subsurface contamination with vapor-forming chemicals may be present underlying or near buildings. A detailed investigation of the vapor intrusion pathway is typically performed as part of the site investigation stage. The recommended approaches and practices for conducting detailed vapor intrusion investigations are described in Section 6.0.

Considerable information, primarily empirical, has been generated regarding evaluation of the vapor intrusion pathway since the pathway emerged as a national issue in the late 1990s and especially in the past ten years. Broadly speaking, this information demonstrates that the vapor intrusion pathway can be complex. (The conceptual model of vapor intrusion provided in Section 2.0 identifies many of the factors, variables, and conditions that warrant consideration on a site-specific basis.) As a result, current practice suggests that the vapor intrusion pathway generally be assessed using multiple lines of evidence.<sup>77</sup>

Specific conclusions that EPA recommends be based upon multiple lines of evidence include:

---

<sup>76</sup> These situations can arise, for example, if the groundwater remedy was selected in the 1980s (long before vapor intrusion became recognized as a potentially significant exposure pathway), or if supplemental groundwater data indicate that the plume is migrating toward new inhabited areas.

<sup>77</sup> As discussed further in Section 7.2, confidence in the assessment and risk management decisions is expected to be higher when multiple independent lines of appropriate site- or building-specific evidence from, for example, multiple types samples of environmental media (e.g., groundwater, soil-gas, sub-slab vapor, crawlspace, and indoor air) and/or other data come together to provide mutually supporting evidence for a common understanding of the site conditions/scenarios and the potential for vapor intrusion (EPA 2010b) (i.e., the various lines of evidence are in agreement with each other).

- The subsurface vapor source(s) at a specific site has (or, alternatively, does not have) the potential to pose an unacceptable vapor intrusion exposure under current or reasonably expected future conditions, due to its strength (e.g., concentration and mass of vapor-forming chemicals) and proximity relative to one or more existing buildings or a building that may be constructed in the future.
- The vapor intrusion pathway is complete for one or more buildings under current conditions or is potentially complete under reasonably expected future conditions.
- The vapor intrusion pathway is incomplete for one or more buildings near a subsurface source of vapor-forming chemicals, due to geologic, hydrologic, and/or biochemical (e.g., biodegradation) processes that provide substantial and persistent attenuation of vapors extending laterally over large distances relative to the footprint of the building(s) and the extent of the vapor source.
- Indoor air concentrations attributable to vapor intrusion pose (or, alternatively, are unlikely to pose) an unacceptable human health risk in one or more existing buildings under current or reasonably expected future conditions.
- Indoor air concentrations measured in one or more buildings can (or alternatively, cannot) be reasonably attributed to indoor or ambient air sources (i.e., background).

Multiple lines of evidence are particularly important for supporting “no-further-action” decisions regarding the vapor intrusion pathway (e.g., pathway incomplete determinations) to reduce the chance of reaching a false-negative conclusion (i.e., concluding vapor intrusion does not pose unacceptable human health risk, when it actually poses an unacceptable human health risk). Collecting and weighing multiple lines of evidence can also help avoid reaching a false-positive conclusion (i.e., concluding vapor intrusion poses an unacceptable human health risk, when it does not).

In summary, EPA recommends that site assessors generally collect and weigh multiple lines of evidence, including qualitative information, to support decision-making regarding the vapor intrusion pathway. Lines of appropriate evidence to evaluate the vapor intrusion pathway were identified in Section 2 and are discussed further in Sections 5 through 7.

As noted in Section 1.3, Figure 3-1, and the preceding discussion of lines of evidence, EPA recommends that site assessors consider reasonably expected future conditions, in addition to current conditions, when reaching conclusions about the vapor intrusion pathway.<sup>78</sup> For this reason, this Technical Guide includes recommendations for evaluating whether subsurface vapor sources that remain have the potential to pose unacceptable human health risks in the future if current conditions were to change. For example:

- Section 6.3.3 recommends that site assessors consider investigating vapor intrusion in non-residential buildings under conditions when the heating, ventilation, and air-conditioning system is not operating; and

---

<sup>78</sup> “Both current and reasonably likely future risks need to be considered in order to demonstrate that a site does not present an unacceptable risk to human health and the environment.” (EPA 1991a).

- Section 7.3 identifies some factors and processes that can make the characteristics of the vadose zone (e.g., soil moisture) transitory.

EPA also recommends that vapor intrusion be evaluated for reasonably expected future land use conditions, including new building construction and new uses and occupants for any uninhabited buildings.

### 3.3 Building Mitigation and Subsurface Remediation

The NCP expresses the preference for response actions that eliminate or substantially reduce the level of contamination in the source medium to acceptable levels, thereby achieving a permanent remedy. In the case of vapor intrusion, such a response action would generally entail eliminating or substantially reducing the level of vapor-forming chemicals in the subsurface (e.g., in contaminated groundwater, soil, and/or sewer lines) via treatment or removal (i.e., “remediation”). Section 8 discusses source remediation to achieve a permanent remedy and associated institutional controls (ICs) and monitoring for vapor intrusion mitigation, including criteria for their termination.

Comprehensive remediation<sup>79</sup> of the subsurface environment often occurs over a prolonged period (e.g., several years) to attain cleanup levels. In the interim, problems of unacceptable vapor intrusion are often addressed by also installing engineered exposure controls to reduce or eliminate vapor intrusion in buildings (i.e., “mitigate” vapor intrusion) or reduce indoor air exposure levels. Engineered exposure controls can generally be deployed and generally become effective relatively quickly. They can be considered as “interim” or “early” response actions, which are also authorized by the NCP (Section 1.2), as necessary and appropriate to promptly reduce threats to human health. Section 8 summarizes technical information about specific exposure controls and provides information about their operation, maintenance and monitoring and associated ICs, including criteria for their termination.

Functionally, engineered exposure controls can be categorized into two basic strategies:

- Those that seek to prevent or reduce vapor entry into a building (e.g., active depressurization technologies). These methods are more commonly implemented when response actions are needed.<sup>80</sup>
- Those that seek to reduce or eliminate vapors that have entered into a building (e.g., indoor air treatment, ventilation).

---

<sup>79</sup> For purposes of this Technical Guide, “remediation” is intended to apply to interim and final cleanups, whether conducted pursuant to RCRA corrective action, the CERCLA removal or remedial programs, or using EPA brownfield grant funds with oversight by state and tribal response programs. In addition to permanent remedies for subsurface vapor sources, site remediation may also entail implementation of ICs and construction and operation of engineered systems to reduce risks to human health and the environment posed by environmental pathways other than vapor intrusion. Although this Technical Guide is intended for use at any site subject to federal statutes, regulations, and rules, it is not intended to alter existing requirements, guidance, or practices in OSWER’s programs about development, selection, or documentation of final “remediation” plans (addressing subsurface vapor sources, for example) – see, for example, Sections 7.6 and 7.7.

<sup>80</sup> Mitigation methods that prevent or reduce vapor entry into a building from subsurface vapor sources would generally also be expected to reduce radon entry.

Neither strategy entails reducing the level of vapor-forming contamination in the subsurface source medium.<sup>81</sup>

As reflected in the foregoing conceptual model of vapor intrusion (Section 2.0), entry of the vapors into a building may be prevented or reduced by any of several techniques, which have the following objectives:

- Remove or reverse the driving forces for vapor intrusion into the building (e.g., install and operate an active depressurization technology to mitigate vapor intrusion from contaminated soil or groundwater; establish over-pressurization within and throughout the footprint of a nonresidential building).
- Eliminate or minimize identified openings for vapor entry into the building (e.g., caulking, grouting, or otherwise sealing all holes, cracks, sumps and other foundational openings or creating a barrier between the soil and the building that blocks openings for entry of soil gas into the building; install, repair, and/or maintain vapor traps in sewer and drain lines).

Engineered exposure controls that entail mechanical systems and forces (e.g., sub-slab depressurization or ventilation systems; building over-pressurization) are often referred to as “active.” Engineered exposure controls that do not involve mechanical operations (e.g., installing a sub-slab barrier to chemical vapor entry) are often referred to as “passive.” Many building mitigation systems rely on both active and passive strategies.

Engineered exposure controls that seek to reduce or eliminate vapors that have entered into a building can also be effective. In some instances, they can be implemented more readily than engineered exposure controls that reduce or eliminate entry of the vapors into a building. Typically, the simplest approach to limiting the concentration levels in occupied indoor spaces is to increase building ventilation (i.e., increase the rate at which indoor air is replaced with outdoor air), thereby diluting indoor air concentrations (see Section 2.4).<sup>82</sup> Alternatively, vapor-forming chemicals are removed from indoor air using an adsorbing material (such as activated carbon) that can be either properly disposed of or recycled. Building mitigation methods that act upon vapor-forming chemicals in indoor air (i.e., rely upon enhanced ventilation or treatment) are generally capable of reducing background levels of chemicals, in addition to reducing indoor levels of vapor-forming chemicals that intrude from subsurface sources.

---

<sup>81</sup> Even when operated for prolonged periods, engineered exposure controls are considered ‘interim’ remedies for purposes of this Technical Guide, because their implementation does not substitute for remediation of the subsurface source(s) of vapor-forming chemicals. Engineered exposure controls may, nevertheless, become part of a final cleanup plan.

<sup>82</sup> It can be difficult to establish a ventilation rate that mitigates vapor intrusion and yields an environment conducive to human occupancy (e.g., considering air temperature or moisture). In addition, ventilation may affect the driving forces for vapor intrusion. For example, mechanically exhausting air from the building will generally contribute to building under-pressurization (see Section 2.3), which may result in increased intrusion of soil gas into the building, which may offset the intended dilution effect of ventilation. On the other hand, introducing outdoor air at a rate slightly greater than the exhaust rate can create over-pressurization, which opposes the primary driving force for vapor intrusion.



Selection of an interim response action from these options may depend upon building- and site-specific factors (EPA 2008). For example, building-specific factors may include:

- Use (e.g., single-family residential, multi-family residential, commercial, educational, recreational, governmental, religious, industrial)
- Type of foundation/basement (e.g., basements with concrete slab floors or dirt floors, slab on grade, slab below grade) and other construction features
- Type of heating/cooling/ventilation systems (e.g., some systems will tend to increase pressure, whereas others will tend to decrease pressure, inside the building).

Each of these characteristics can influence the choice of mitigation methodology and, therefore, they are commonly identified during building surveys during a site-specific vapor intrusion investigation. Site-specific considerations may include the degree of risk or hazard being addressed and whether the subsurface vapor source(s) is stable in extent and concentration or is undergoing remediation.

Temporary relocation may warrant consideration in instances where explosion hazards are present (see Section 7.5.1), which may pose an imminent and substantial danger to human health and public welfare. Prompt response action may also be warranted where short-term or acute exposures may pose unacceptable human health risk (see Section 7.5.2) that cannot be addressed timely or feasibly by implementing engineered exposure controls. Section 8.2 discusses various prompt response actions for such situations, which may include temporary relocation.

There may be situations where a party may wish to implement mitigation or control measures for vapor intrusion, even though only limited lines of evidence or measurements may be available to characterize the overall vapor intrusion pathway. For example, a party may be aware that vapor intrusion has been documented at neighboring structures, where measures are being implemented to mitigate the vapor intrusion pathway. A party may conclude there is a reasonable basis to take action, but each building presents a fact-specific situation that calls for its own individual judgment. Likewise, it may be appropriate and cost-effective to design, install, operate, and monitor engineered exposure controls for individual buildings to mitigate vapor intrusion in newly constructed buildings, or in buildings to be constructed in the future, that are located in areas of vapor-forming subsurface contamination, rather than potentially allow vapor intrusion to occur later and assess vapor intrusion after the fact. The term “preemptive mitigation/early action” is used in this Technical Guide to describe these situations.<sup>83</sup>

The decision for preemptive mitigation/early action arises from precaution and from recognizing that:

- Installing engineered exposure controls in buildings is typically a cost-effective means of protecting human health and normally can be implemented relatively quickly in many buildings while subsurface contamination is being delineated or remediated.

---

<sup>83</sup> The term ‘preemptive’ has been used to describe the use of various types of controls that can prevent vapor intrusion from occurring prior to having fully demonstrated that unacceptable vapor intrusion currently exists in specific buildings being considered (EPA 2010a).

- Conventional vapor intrusion investigations can be disruptive for building occupants (residents, workers, etc.) and owners.
- Comprehensive subsurface characterization and investigation of vapor intrusion can entail prolonged study periods, during which time building occupants and owners and others may have questions and concerns about human health risk that are or may be posed via vapor intrusion.

Early action and interim action are allowed by federal environmental protection statutes, regulations, and guidance, including CERCLA, as amended, and RCRA, as amended – see Section 1.2 of this Technical Guide, for example. Other aspects of preemptive mitigation/early action are also discussed in Section 7.8, including situations and criteria for decision-makers to consider.

As noted in Figure 3-1, EPA recommends that risk managers consider reasonably expected future conditions, in addition to current conditions, when making risk management decisions about the vapor intrusion pathway. For this reason, this Technical Guide includes recommendations for response actions at sites where subsurface vapor sources remain into the future, but do not pose unacceptable human health risk under current conditions (e.g., no building is present nearby). For example, institutional controls are generally recommended to restrict land use and/or alert parties (e.g., prospective developers, owners, and municipalities) of the presence of subsurface sources of vapor-forming chemicals at levels that pose a continuing threat via vapor intrusion (see Sections 7.3, 7.4, and 8.6). When infrastructure conditions change above or near an area of known contamination with vapor-forming chemicals, EPA recommends a vapor intrusion investigation or pre-emptive mitigation be conducted, particularly if a building is constructed for human occupancy (see Section 8.2.3).

### **3.4 Community Outreach and Involvement**

EPA is committed to transparency and upfront collaboration with community stakeholders regarding land cleanup, emergency preparedness and response, and management of hazardous chemicals and wastes. OSWER's Community Engagement Initiative (CEI), in particular, is designed to enhance OSWER's and the Regional offices' engagement with local communities and stakeholders (e.g., state and local governments, tribes, academia, private industry, other federal agencies, and nonprofit organizations) to help them participate meaningfully in government decisions regarding OSWER's nationwide programs.

Meaningful and sustained community outreach and engagement efforts are critical to the implementation of work plans for site-specific vapor intrusion assessment and mitigation. Because assessing the vapor intrusion pathway may involve sampling in a home or workplace, as well as other temporary inconveniences (e.g., assisting in reducing indoor sources of contaminants), individual, one-on-one communication with each property owner or renter generally warrants consideration. Building-by-building contact and communication are recommended as the most effective means of educating the community and obtaining access needed to assess, mitigate, and monitor the vapor intrusion pathway. Personal contact is further recommended to establish a good working relationship with each building owner or occupant and to build trust. In many instances, local religious and cultural organizations, and other community groups can be sought for assistance in reaching out to affected community members.

Vapor intrusion education and training are important components of meaningful community outreach and engagement efforts. Informing stakeholders about the vapor intrusion pathway and the cleanup process can help to build trust and can foster community participation in the overall assessment and risk management process.

Recognizing the importance of community outreach and engagement efforts, EPA staff are highly encouraged to consult with colleagues experienced in community outreach and utilize available EPA planning resources, including those discussed in Section 9, which provides OSWER's community involvement planning guide for vapor intrusion projects. Like EPA, the ITRC also recommends implementing a community outreach program that provides timely information to concerned community members and property owners.

## 4.0 CONSIDERATIONS FOR NONRESIDENTIAL BUILDINGS

The approach for investigating and, if necessary, mitigating vapor intrusion can vary from site to site, and from building to building, due to site- and building-specific factors and circumstances, including: the nature (e.g., mixture of vapor-forming chemicals and form), locations, and extent of subsurface contamination; geologic, hydrologic, and biochemical factors in the vadose zone; and the size, structural conditions and uses of buildings and background levels of vapor-forming chemicals in the building. Information on ‘background’ contributions of site-related, vapor-forming chemicals in indoor air is important to risk managers because generally EPA does not clean up to concentrations below natural or anthropogenic background levels (EPA 2003e). These statements hold true for residential and non-residential buildings.

Section 6.3.5 of this Technical Guide provides specific recommendations about how to evaluate background concentrations. Section 7.4 of this Technical Guide provides clarifications and recommendations about applying the methods in Section 6.3.5 to informing risk management decisions and recommendations. The Glossary in this Technical Guide defines various terms and types of vapor sources to foster a common understanding of EPA’s approach and recommendations.

This section summarizes EPA’s general recommendations to consider in making decisions about evaluating and addressing potential vapor intrusion for nonresidential buildings<sup>84</sup> pursuant to CERCLA and RCRA, including decisions that a response action or corrective action is not currently warranted.

When evaluating nonresidential buildings at sites that have subsurface contamination with vapor-forming chemicals, EPA generally recommends that building owners or operators (e.g., lessees) be contacted for information about vapor-forming chemicals used or stored or otherwise present in the building, the types of building occupants potentially exposed to subsurface vapor intrusion, as well as any training, equipment, or engineering controls to mitigate inhalation exposures. EPA recommends that information be provided to building owners concerning the potential for vapor intrusion so that this information can be communicated to building employees, tenants, and other occupants. Building occupants include, but are not limited to, facility employees, visitors, customers, suppliers, and building maintenance personnel.

Generally, EPA recommends the following factors be considered when making decisions pertaining to vapor intrusion at nonresidential buildings, including as to whether indoor air sampling, soil gas sampling underneath the building, or interim measures to mitigate vapor intrusion to reduce associated indoor air exposures for a nonresidential building may be warranted:

---

<sup>84</sup> As used in this Technical Guide, the phrase “nonresidential buildings” may include, but is not limited to, institutional buildings (e.g., schools, libraries, hospitals, community centers and other enclosed structures for gathering, gyms and other enclosed structures for recreation), commercial buildings (e.g., hotels, office buildings, many (but not all) day care facilities, and retail establishments); and industrial buildings where vapor-forming substances may or may not be routinely used or stored.

- 1) The types of populations potentially exposed to vapor-forming chemicals in the indoor air of the nonresidential building, including, for example, whether:
  - a) Individuals are or may be present under current or reasonably expected future conditions who would not likely anticipate any chemical exposures (e.g., office workers, visitors, customers, suppliers, and other members of the general public) and may not benefit fully from hazard communication programs and other work practices in place to foster protection of workers who use chemicals, if any.
  - b) Sensitive populations are or may be present under current or reasonably expected future conditions, who may have increased susceptibility or vulnerability.
- 2) The potential for vapor intrusion versus background vapor sources (See Glossary) to contribute to indoor air concentrations of vapor-forming chemicals found in the subsurface. Questions to consider include, for example:
  - a) Can subsurface vapor intrusion be identified as a potential cause of unacceptable human health risk to building occupants (see Section 5 for further discussion about the preliminary analysis stage and Section 7 for further discussion and definition of acceptable versus unacceptable human health risk)?<sup>85</sup>
  - b) Can subsurface remediation (e.g., excavation of contaminated soil or soil vapor extraction beneath the subject building) that is planned or underway reduce human health risk from vapor intrusion within a time frame that is protective for any potential current or near-term exposures in the building?
  - c) Is there a known source(s) of one or more vapor-forming chemical(s) – see Section 3.1 – in indoor air in the nonresidential building other than vapor intrusion (e.g., indoor use and storage of chemicals, which would constitute a ‘background’ vapor source(s) and contribute to indoor air exposure concentrations; see Sections 2.7 and 6.3.5 for further discussion and recommendations about background sources and concentrations)? If such a vapor-forming chemical(s) is (or are) present:
    - i. Is(are) it the same as the vapor-forming chemical(s) found in the subsurface?
    - ii. How does the indoor air exposure concentration(s) arising from the indoor vapor source(s) compare to the indoor air concentration(s) estimated or reasonably expected to arise from vapor intrusion?<sup>86</sup>

Information on ‘background’ contributions of site-related, vapor-forming chemicals in indoor air is important to risk managers because generally EPA does not clean up to concentrations below natural or anthropogenic background levels (EPA 2002e).

---

<sup>85</sup> EPA’s recommended approaches to human health risk assessment are provided in Sections 7.4 and 7.5 of this Technical Guide.

<sup>86</sup> EPA’s recommended approaches to distinguishing and considering ‘background’ are provided in Sections 6.3.5 and 7.4.2 of this Technical Guide.

- 3) Any existing or planned engineering or institutional control(s) in the building or any industrial hygiene/occupational health program that addresses workplace inhalation exposures and its scope. Questions to consider include, for example:
  - a) Do work practices and engineering controls currently in place ensure protection<sup>87</sup> of all building occupants who may be exposed via the vapor intrusion pathway?
  - b) Are enforceable institutional controls (ICs) or other control mechanisms in place to ensure that current land use and workplace practices will be sustained and will remain protective regarding indoor air exposures from vapor intrusion to all building occupants? Have these ICs and control mechanisms been communicated to all appropriate parties and documented to EPA? Can they be readily monitored and, if necessary, be enforced?

EPA recommends documenting any decision not to undertake investigation or mitigation for vapor intrusion in a nonresidential building, as well as any decision to pursue such activities. EPA may consider reviewing these decisions, as appropriate and consistent with applicable statutes and regulations and considering EPA guidance,<sup>88</sup> if the land use changes or new information becomes available that suggests circumstances supporting past risk management decisions have changed and prompt the need to revisit those decisions. It is recommended that EPA request from property owners and building tenants/operators timely notification of significant changes in building ownership, uses, access by the general public, or building construction (e.g., renovations), which may affect exposure of occupants and related risk management decisions pertaining to potential vapor intrusion assessment and mitigation, subsurface remediation, or ICs.

Regardless of decisions about indoor air sampling, soil gas sampling underneath the building, or interim measures to mitigate vapor intrusion, EPA<sup>89</sup> may proceed, consistent with applicable federal statutes and regulations (see Section 1.2) and considering EPA guidance, with activities such as the following, where appropriate:

- Subsurface investigation to delineate the areal extent of a subsurface vapor plume.
- Subsurface remediation to reduce or eliminate subsurface sources of vapors-forming chemicals to protect human health and the environment.

---

<sup>87</sup> EPA's recommended approaches to risk management are provided in Sections 7.4 and 7.5 of this Technical Guide.

<sup>88</sup> For the Superfund five-year review process, OSWER Directive 9200.2-84 (EPA 2012c) provides a recommended framework for considering vapor intrusion while evaluating remedy protectiveness.

<sup>89</sup> On January 23, 1987, the President of the United States signed Executive Order 12580 entitled, "Superfund Implementation," which delegates to a number of Federal departments and agencies the authority and responsibility to implement certain provisions of CERCLA. The policies and procedures for implementing these provisions (e.g., carrying out response actions) are spelled out in the NCP. The provisions of Executive Order 12580 appear at 52 *Federal Register* 2923. At federal facilities on the NPL, EPA may not be the lead agency, but does have oversight responsibilities pursuant to CERCLA Section 120.

## 5.0 PRELIMINARY ANALYSIS OF VAPOR INTRUSION

When a site is first identified and evaluated for vapor intrusion,<sup>90</sup> the amount, utility, and reliability of available information may be limited. A preliminary analysis utilizes available and readily ascertainable information to develop an *initial* understanding of the potential for human health risk to be posed by vapor intrusion, which would typically be performed as part of an initial site assessment.

This section describes EPA's recommended information, approaches, and practices for conducting preliminary analyses for vapor intrusion using pre-existing and readily ascertainable information to develop an initial understanding of the vapor intrusion potential at a site. This section:

- Explains the recommended types of information that generally can be obtained when a site is first considered for vapor intrusion (see Sections 5.1, 5.3, 5.4, and 5.5).
- Identifies some of the site conditions for which prompt action is generally warranted (see Section 5.2).
- Illustrates some of the site conditions for which further evaluation of the vapor intrusion pathway might be warranted (see Sections 5.3, 5.4, and 5.5).
- Describes the recommended approaches to evaluating the reliability of pre-existing information, including any sampling data (see Sections 5.1 and 5.5).

Depending upon the nature and reliability of the available information, it may be possible to determine whether a vapor intrusion investigation (see Section 6) or a response action (see Sections 7 and 8) is warranted. If the available information is not reliable or adequate for these purposes, however, additional data collection generally is recommended.

### 5.1 Assemble, Evaluate, and Review Available Information

The recommended first step in a preliminary analysis generally entails assembling and reviewing relevant information that is available at the time for the site. At a minimum, EPA recommends that information about potential subsurface sources of vapors and the presence and current use(s) of nearby buildings be developed and evaluated. For some sites, such as sites being evaluated for redevelopment (EPA 2008a), information about contiguous or nearby facilities also may be relevant, because vapors can encroach from nearby facilities due to migration of contaminated groundwater or soil gas, even though vapor-forming chemicals may not have been used at the subject site.

The following recommended types of information are often available through documents (e.g., federal, state, tribal and local government records) or through interviews with individuals

---

<sup>90</sup> A site may be identified, for example, based on reports to the National Response Center, citizen complaints or inquiries, state agency referrals, or other information (e.g., site history, land use, site inspections) obtained by EPA. At a brownfield site subject to an EPA grant, subsurface contamination may be discovered as a result of pre-acquisition investigation by prospective purchasers, during site redevelopment, or at other project stages.

knowledgeable about the facility or site and surrounding area (e.g., past and present owners, operators and occupants; area residents or workers):

- History and descriptions of the types of operations and activities that occurred on or near the site and nearby properties.
- Information or records about the types of chemicals that may have been used or disposed of at the site and nearby properties or are currently used and disposed at the site.
- Information about the site and nearby properties, such as the occurrence of odors, reports of dumping liquids, observations of unreported waste disposal practices, or other indications of chemical presence and release.
- Adverse physiological effects reported by building occupants (e.g., dizziness, nausea, vomiting, confusion).
- Evidence of subsurface intrusion of groundwater (e.g., wet basements) reported by building owners or occupants.

Such information usually can be reviewed and weighed together to assess whether vapor-forming chemicals (see Section 3.1) were or are being used, stored, or handled at or near the site and were or may have been released to the subsurface environment.

In addition, the following types of information may be available through documents, interviews with individuals knowledgeable about the facility or site, or reconnaissance and site inspection:

- Locations, ownership, occupancy, and intended and actual use(s) of buildings on or near the site.
- Current and reasonably anticipated future land use on and near the site.
- Location of subsurface utility corridors.

Evaluation of such information usually can help determine whether humans are present currently or are reasonably expected to be present in the future, and who may become exposed to any intrusion of vapors from the subsurface into a building(s). Zoning, land use planning, and related information may also need to be consulted to identify reasonably anticipated future land use and building types in areas where buildings do not exist or to ascertain whether reasonably anticipated uses of existing buildings are likely to change (EPA 2010c).

EPA recommends evaluating the available data to identify any data gaps for purposes of the preliminary analysis. For example, has the history of operations and primary activities been established for the site and all contiguous properties, including currently vacant land? To the extent that there are significant data gaps, EPA recommends that additional data gathering (e.g., interviews, records review) generally be planned and conducted.

EPA also recommends evaluating the available data to assess its reliability and internal consistency. For example, if the available information about operations and activities at a specific property comes only from area residents, EPA recommends additional efforts to



identify, contact, and interview current and past owners to obtain and corroborate this information. Also, if anecdotal information about current activities at a specific property is in conflict with common knowledge about local zoning, EPA recommends that additional data gathering and evaluation be identified (e.g., contact property owner), planned, and conducted to resolve the inconsistency.

Section 5.5.1 describes additional considerations for evaluating the reliability of sampling data that may be available for some sites at the preliminary analysis stage.

## 5.2 Identify and Respond to Conditions that Warrant Prompt Action

The following conditions may indicate a need for prompt action, including follow-up evaluations to determine whether urgent intervention is warranted to eliminate, avoid, reduce, or otherwise address a human health hazard:

- Odors reported by occupants, particularly if described as “chemical,” “solvent,” or “gasoline.” The presence of odors does not necessarily correspond to an unacceptable human health risk due to vapor intrusion, and the odors could be the exclusive result of indoor vapor sources; however, it is generally prudent to investigate any reports of odors as the odor threshold for some vapor-forming chemicals exceeds their respective lower explosive limit (LEL) or health-protective concentrations for short-term or acute exposure.
- Physiological effects reported by occupants (e.g., dizziness, nausea, vomiting, confusion, etc.). These effects may or may not be due to subsurface vapor intrusion (or even indoor vapor sources); however, it is generally prudent to investigate any such reports.
- Wet basements in areas where groundwater is known to contain vapor-forming chemicals (see Section 3.1) and the associated water table is shallow enough that the basements are prone to groundwater intrusion or flooding. This condition is particularly important where there is evidence of light NAPL (LNAPL) on the water table directly below the building or direct evidence of intrusion of liquid-phase contamination (i.e., liquid chemical or dissolved in water) inside the building.

EPA generally recommends testing of indoor air (see Sections 6.4.1 and 6.3.4) as soon as practical in buildings where:

- chemical odors or physiologic effects are reported and there is a credible information to suggest that a release to the subsurface environment may be a contributing factor, or
- intruding contaminated groundwater is reported and observed.

Likewise, EPA generally recommends testing of unoccupied structures for explosive gases as soon as practical where chemical odors are reported and there is a credible information to suggest that a release to the subsurface environment may be a contributing factor.

Section 7.4 provides EPA’s approach and recommendations for identifying when human health risks are “unacceptable.” Section 7.5.2 describes EPA’s recommended approaches to identifying concentration levels indicating a potential need for prompt response action. Section

8.2.1 identifies potential response actions to reduce or avoid these threats promptly, when the results of testing reveal threats or potential threats warranting prompt response action.

EPA recommends health and safety planning for all building- or site-specific actions, as discussed further in Section 6.2, which considers expected work conditions and anticipated hazards.

### **5.3 Determine Presence of Structures and Vapor-forming Chemicals**

For purposes of this Technical Guide and as reflected in the conceptual model of vapor intrusion (Section 2), the vapor intrusion pathway is referred to as “complete” for a specific building or collection of buildings when the following five conditions are met under current conditions:

- 1) A subsurface source of vapor-forming chemicals is present underneath or near the building(s) (see Sections 2.1, 6.2.1, and 6.3.1);
- 2) Vapors form and have a route along which to migrate (be transported) toward the building(s) (see Sections 2.2 and 6.3.2);
- 3) The building(s) is (or are) susceptible to soil gas entry, which means openings exist for the vapors to enter the building(s) and driving ‘forces’ exist to draw the vapors from the subsurface through the openings into the building(s) (see Sections 2.3 and 6.3.3);
- 4) One or more vapor-forming chemicals comprising the subsurface vapor source(s) is (or are) present in the indoor environment (see Sections 6.3.4 and 6.4.1); and
- 5) The building(s) is (or are) occupied by one or more individuals when the vapor forming chemical(s) is (or are) present indoors.

EPA recommends that site managers also evaluate whether subsurface vapor sources that remain have the potential to pose a complete vapor intrusion pathway in the future if site conditions were to change (e.g., reasonably expected occupancy or construction in the future of a building above or near a subsurface vapor source). A complete vapor intrusion pathway indicates that there is an opportunity for human exposure, which warrants further analysis (see Section 7.4) to determine whether there is a basis for undertaking a response action(s) (see Section 7.7).

At the preliminary assessment stage, the available information may not be sufficient to evaluate whether all five conditions are present under current or reasonably expected future conditions. EPA recommends, however, that readily ascertainable information be reviewed for purposes of assessing whether the first and fifth conditions are present; that is:

- A subsurface source of vapor-forming chemicals is present or is reasonably expected to be present (e.g., in contaminated groundwater, soil, or sewer lines or from a primary

vapor release).<sup>91</sup> Section 3.1 describes chemicals that have the potential to pose an unacceptable human health risk through the vapor intrusion pathway. In the absence of environmental sampling data, the potential presence of vapor-forming chemicals in the subsurface may be inferred from site information, as identified in Section 5.1 (e.g., site history).

- At least one building is present or is reasonably expected to be constructed in the future above or “near” the subsurface vapor source(s), which is or could be occupied by humans. For purposes of this Technical Guide and its recommendations for evaluating human health risk posed by vapor-forming chemicals, “building” refers to a structure that is intended for occupancy and use by humans. This would include, for instance, homes, offices, stores, commercial and industrial buildings, etc., but would not normally include sheds, carports, pump houses, or other structures that are not intended for human occupancy. However, where the assessment identifies the potential for methane or other potentially explosive vapors to be present in the subsurface, EPA recommends reviewing readily ascertainable information for purposes of assessing whether non-occupied structures (including, but not limited to, sewers, pits, and subsurface drains) are present, which may also accumulate vapors, in addition to occupied and non-occupied buildings. Existing buildings (and non-occupied structures) can be identified during inspections of the land areas overlying and near subsurface vapor sources. The potential presence of buildings in the future may be inferred from site information, such as identified in Section 5.1. See Section 6.2.1 for further discussion on which buildings and non-occupied structures are considered “near” for purposes of a preliminary analysis.

If the available information is deemed reliable, well documented, and sufficient (see Section 5.1) and indicates that neither of these conditions is met, then further vapor intrusion assessments are not generally warranted.<sup>92</sup>

*Example: From 1920 to 1931, the ABC Mining Company obtained and shipped iron ore from a local deposit. Ore from the mine was shipped by rail to a different location where it was milled and processed to extract the metal. Although no company records are available for the mine, a review of mining techniques indicates that solvents and other vapor-forming chemicals were not used in the mining process during the 1920s and 1930s. Former mining structures have been removed, and the site is currently vacant. The city has proposed redeveloping the site with bike and hiking trails but no buildings or other structures for storage or site maintenance support. Based on the information and*

---

<sup>91</sup> As noted in Section 2.1, the primary contamination source need not be on the property of interest to pose a vapor intrusion problem. The primary source(s) of vapor-forming chemicals (e.g., contaminated soil, leaking tanks) may be present on a neighboring property or on a property some distance away. Even “greenspace” properties that have not previously been occupied or developed may contain subsurface contamination by vapor-forming chemicals due to migrating plumes of contaminated groundwater or migrating soil gases. Therefore, EPA recommends that the potential for vapor intrusion be considered at all properties being considered for redevelopment (EPA 2008a) or proximate to industrial and commercial use areas.

<sup>92</sup> Consistent with federal environmental protection statutes, regulations, and OSWER guidance, a subsurface investigation may still be warranted for non-volatile substances or for other potential exposure pathways such as those identified in Section 1.3.

*findings, the need for further assessment of the vapor intrusion pathway due to mining-related contamination is not indicated.*

If, on the other hand, there is reliable evidence to indicate that a release of vapor-forming chemicals to the subsurface has occurred (e.g., environmental sampling data indicate detectable levels of a vapor-forming chemical(s) in potential source media)<sup>93</sup> or may have occurred underneath or near a property, then EPA recommends further vapor intrusion assessment in areas where buildings are present or future buildings could be constructed, including development of a conceptual site model (see Section 5.4) and investigation of site-specific conditions (see Section 6).

*Example: The XYZ Recycling Center site was used from 1963 to 1984 for the collection and recycling of industrial solvents and other fluids. The site was repeatedly cited by the state and city for improper handling and disposal of solvents, and was closed in 1985. Groundwater data indicate the presence of multiple chlorinated hydrocarbons. Buildings overlying the contaminated groundwater are currently used mainly for storage of non-chemical goods, but the site has been proposed for future residential or commercial redevelopment. Based on the foregoing information and findings, further assessment of the potential for vapor intrusion is warranted, possibly including risk-based screening of the groundwater data (see Section 6.5).*

If a release of vapor-forming chemicals to the subsurface is known or suspected to have occurred at or near the site, but buildings are not present and none are reasonably anticipated in the future (e.g., the contaminated source underlies an open space, recreational area, or wildlife refuge), then further vapor intrusion assessments may not be appropriate under current conditions. It may be appropriate, however, to establish an institutional control (IC) requiring a vapor intrusion investigation or building mitigation<sup>94</sup> in the future, in case land use changes. ICs for building mitigation and subsurface vapor source remediation are discussed further in Sections 3.3 and 8.6 of this Technical Guide.

Existing guidance and practice pursuant to CERCLA and RCRA corrective action (CA) recognize and entail various phases of subsurface or site characterization, including a site investigation to determine the full nature and extent of contamination at a site, quantify risks posed to human health and the environment, and gather information to support the selection and implementation of appropriate remedies. On this basis, a subsurface investigation may be warranted at some point to characterize subsurface contamination and assess the need for subsurface remediation to protect the environment and human health for potential exposure pathways other than vapor intrusion (such as those identified in Section 1.3). For example, site investigations to characterize the nature and extent of groundwater contamination and support assessments of risk to human health through the ingestion pathway are typically conducted, consistent with federal statutes and regulations (e.g., CERCLA and RCRA) and considering EPA guidance.

---

<sup>93</sup> Section 6.5 provides information on how such data may be used in a quantitative fashion to screen the site further.

<sup>94</sup> If, for example, a developer is considering acquiring and building on land that contains subsurface contamination with vapor-forming chemicals, the developer could retrofit existing buildings or build new buildings with vapor mitigation systems without first conducting an extensive vapor intrusion investigation (see Sections 3.3 and 7.8). Section 8.2.3 identifies additional approaches and considerations for new buildings.

## 5.4 Develop Initial Conceptual Site Model

EPA recommends that the planning and data review team develop an initial conceptual site model (CSM) for vapor intrusion when the preliminary analysis indicates the presence of subsurface contamination with vapor-forming chemicals underlying or near buildings. The initial CSM (and any subsequent refined CSM) can be used to support evaluations of the adequacy of the available site-specific information, to guide any vapor intrusion investigations (see Sections 6.2 and 6.3), and to support data selection for risk-based screening (see Section 6.5). The CSM can also provide useful information for supporting prompt development of a strategy for early/interim response actions (see Sections 7.8 and 8.2).

The remainder of this section discusses recommended information that can be useful for developing a CSM. Note that some of the recommended information may not be readily available when a site is first considered for vapor intrusion. Although the CSM may be updated iteratively (and interim mitigation measures may be undertaken) as the vapor intrusion investigation unfolds, EPA recommends completing the CSM before making final risk management decisions for a given site (see Section 7).

As discussed in Section 5.3, the available information may not be sufficient at the preliminary analysis stage to evaluate whether the vapor intrusion pathway is complete under current or future conditions. Therefore, the initial CSM for vapor intrusion is likely to be incomplete. EPA recommends, however, that the initial CSM for vapor intrusion portray the current understanding of site-specific conditions pertaining to the vapor intrusion pathway. Ideally, at a minimum, the initial CSM will address:

- Nature (i.e., type, chemical composition), location, and spatial extent of the source(s) of vapor-forming chemicals in the subsurface (see Sections 2.1 and 6.3.1, for example). For example, it is useful to know which vapor-forming chemical(s) primarily comprise the subsurface vapor source<sup>95</sup> and whether it is also capable of posing explosion hazards. It is also useful to know whether vapor-forming chemicals are present in groundwater, vadose zone soils, sewer lines, and/or some other source underneath or near buildings.
- Location, use, occupancy, and basic construction (e.g., foundation type) of existing buildings.

The CSM can be updated as additional information is obtained through investigation (Section 6) and building surveys (Section 6.4.1).

EPA recommends the CSM also portray the current understanding of the hydrologic and geologic setting in and around the subsurface vapor source(s) and the buildings, which is expected to influence vapor migration and attenuation in the vadose zone (see Sections 2.2 and 6.3.2, for example). When these conditions are not well established from existing information, and the preliminary analysis indicates the presence of subsurface contamination with vapor-

---

<sup>95</sup> EPA also recommends that the CSM identify any site-specific chemicals of concern that may be biodegradable and identify and summarize information and data pertaining to the possible role of biodegradation *in situ* in limiting vapor migration in the vadose zone (see Section 6.3.2) or generating hazardous, volatile degradation products (e.g., methane from anaerobic biodegradation, vinyl chloride as a byproduct of PCE or TCE biodegradation).

forming chemicals underlying or near buildings, EPA recommends that a detailed vapor intrusion investigation be scoped and conducted to address these data gaps (see Section 6.3).

Furthermore, EPA recommends the CSM identify known or suspected preferential migration routes that could facilitate vapor migration to greater distances and at higher concentrations than otherwise expected. EPA recommends that buildings with significant preferential migration routes be evaluated closely. For the purposes of this Technical Guide, a preferential migration route is a naturally occurring subsurface feature or anthropogenic (human-made) subsurface conduit that is expected to exhibit little resistance to vapor flow in the vadose zone (i.e., exhibits a relatively high gas permeability) or groundwater flow (i.e., exhibits a relatively high hydraulic conductivity), depending upon its location and orientation relative to the water table and ground surface, thereby facilitating the migration of vapor-forming chemicals in the subsurface and/or into buildings.<sup>96</sup> Naturally occurring examples include fractures and macropores, which may facilitate a preferential route for either the vertical or horizontal migration of source materials and/or vapors. Anthropogenic examples include sewer lines and manholes,<sup>97</sup> utility vaults and corridors, elevator shafts, subsurface drains, permeable fill, and underground mine workings that intersect subsurface vapor sources or vapor migration routes. In highly developed residential areas, extensive networks of subsurface utility corridors may be present, which can significantly influence the migration of contaminants. A preferential migration route can be a “significant” influence on vapor intrusion when it is of sufficient volume and proximity to a building that it may be reasonably anticipated to influence vapor migration towards or vapor intrusion into the building. Significant vertical routes of preferential migration may result in higher than anticipated concentrations in the overlying near-surface soils, whereas significant horizontal routes of preferential migration may result in elevated concentrations in areas on the periphery of subsurface contamination (see Section 6.2.1).

CSMs for vapor intrusion assessments often need to consider two distinct exposure situations:

- 1) At some sites and contaminated locations, there are concerns as to whether vapor intrusion may pose a human health risk to current occupants of an existing building(s). For this situation, EPA recommends that building-specific information be available to support the CSM, which may be obtained through a building survey (see Section 6.4.1, for example) .
- 2) At other sites and contaminated locations, buildings are not present, but are expected to be constructed, and building-specific information may not be available to support the CSM. For this situation, the CSM may need to consider a hypothetical building constructed anywhere over (or near) the subsurface vapor source.

---

<sup>96</sup> For purposes of this Technical Guide, preferential migration routes are distinguished from adventitious and intentional openings in a building that may also facilitate vapor entry from the subsurface (see Section 2.3), but which are expected to typically be present in all buildings (e.g., cracks, seams, interstices, and gaps in basement floors and walls or foundations; perforations due to utility conduits).

<sup>97</sup> In addition to receiving direct discharges of aqueous and chemical wastes from commercial and industrial operations, sewers can be indirect receptacles of subsurface contamination via infiltration of NAPL, soil gas, or contaminated groundwater through cracks in piping and manholes (see Section 2 of this Technical Guide, for example, for further discussion).

In general, CSMs identify the potentially exposed populations, potential exposure routes, and potential adverse health effects (i.e., toxicity) arising from these exposures. As such, EPA recommends the CSM also identify and consider sensitive populations, including but not limited to:

- Elderly,
- Women of child-bearing age,
- Infants and children,
- People suffering from chronic illness, or
- Disadvantaged populations (i.e., an environmental justice situation).

By definition and as noted in Section 2, the exposure route of general interest for vapor intrusion is inhalation of vapors in indoor air and the human population of primary interest is comprised of individuals living or working in or otherwise occupying a building subject to vapor intrusion. However, EPA also recommends that the CSM identify any site-specific chemicals of concern that have potential for explosion hazards (e.g., methane) or for posing other routes of exposure (e.g., dermal exposure to shallow contaminated groundwater seeping into a basement).

EPA recommends that the CSM also identify and characterize suspected sources of site-related, vapor-forming chemicals that are also found in ambient air in the site vicinity. In some situations, site-related contamination has the potential to impact ambient air with the same vapor-forming chemicals that pose a threat from vapor intrusion. For example, contamination of shallow soil or groundwater may release site-related vapor-forming chemicals to ambient air. EPA recommends the CSM identify any such conditions, which have implications for the scope and objectives of the overall site investigation, as well as for data evaluation and the human health risk assessment.

To document current site conditions, EPA recommends that a CSM be supported by maps, cross sections, and site diagrams, to the extent practical, and that the narrative description clearly distinguish what aspects are known or determined and what assumptions have been made in its development.

EPA generally recommends that developing a CSM be incorporated into the first step in EPA's data quality objective (DQO) process (EPA 2006a). It is rare for a site to have readily available sources of sufficient information to develop a complete CSM when the vapor intrusion potential is first considered. For example, a detailed site-specific investigation may be necessary to characterize the full extent of subsurface vapor sources and geologic conditions underlying nearby buildings (see Sections 6.3.1 and 6.3.2) and to demonstrate the absence of preferential routes for vapor migration and intrusion. The CSM normally warrants updating as new information is developed and new questions are framed and answered. A well-defined, detailed CSM may also facilitate the identification of additional data needs and development of appropriate detection limits for laboratory and field analyses, which can support planning of the detailed vapor intrusion investigation (see Section 6.2) and site-specific human health risk assessment, if any (see Section 7.4). Sections 6.3, 6.4, 7.1, and 7.2 provide additional information about data collection and evaluation for purposes of supporting the CSM.

## 5.5 Evaluating Pre-Existing and Readily Ascertainable Sampling Data

Sites and adjacent facilities that have been the subject of previous environmental investigations or regulatory actions may already have data on contaminant concentrations in site media (i.e., sampling data) when the vapor intrusion pathway is first considered and evaluated. Some of these sites and facilities may be undergoing remediation but warrant a vapor intrusion assessment as a result, for example, of changing toxicity information for vapor-forming chemicals, as part of a periodic review of remediation effectiveness and protectiveness (if any), or for other reasons.

If the pre-existing environmental data are deemed reliable and other conditions are met (as described in the remainder of this subsection and in Section 6.5.2), the sampling data may be compared to recommended generic vapor intrusion screening criteria (see Section 6.5) for purposes of developing some preliminary insights about the potential level of exposure and risk posed by vapor intrusion. Such a screening can, for example, help focus a subsequent vapor intrusion investigation (see Section 6) or provide support for considering building mitigation as an early action (see Section 7.8.2), depending upon building- and site-specific circumstances. Note that some of the site-specific information generally recommended for supporting a risk-based screening (see Section 6.5.2) may not be available when a site is first considered for vapor intrusion.

### 5.5.1 Evaluate Sampling Data Reliability and Quality

To the extent that environmental sampling data are identified for the site or nearby properties, EPA recommends that these data be evaluated to determine whether they are of sufficient quality and reliability to support a comparison to recommended generic vapor intrusion screening criteria (see Section 6.5). Some questions that could be considered when reviewing historical sampling data include:

- How were the samples collected and analyzed? EPA recommends using pre-existing data when they have been collected and analyzed by methods considered reliable by today's standards.
- How old are the data? Were analyses conducted for all vapor-forming chemicals known or suspected to be present and reasonably expected degradation products? EPA recommends using pre-existing data when they can be considered representative of current conditions.
- Were the reporting limits sufficiently low for comparison with vapor intrusion screening criteria? EPA recommends use of pre-existing data with non-detect results only when they can be considered reliable on this basis.
- Were multiple locations sampled to assess spatial variability of the results? Were multiple sampling events conducted to assess temporal variability of the results? EPA recommends characterizing spatial and temporal variability to increase confidence in



data evaluation and decision-making and ensure consideration of a reasonable maximum vapor intrusion condition.<sup>98</sup>

EPA also recommends that the reliability of any historical sampling data be assessed by considering the principles for collecting subsurface and indoor air samples that are described in Sections 6.3.1 and 6.4 of this Technical Guide. In addition, the EPA's *Guidance for Data Usability in Risk Assessment, Part A* (EPA 1992a) outlines a recommended approach for evaluating whether the data are useable for the human health risk assessment. As such, its recommended approach is also worthwhile and complementary for evaluating the quality and usefulness of historical data collected at a site.

### 5.5.2 Evaluate Applicability of the VISLs and Adequacy of the Initial CSM

Before performing any comparison of existing sampling data to recommended generic vapor intrusion screening levels (VISLs) (see Section 6.5), it is important to verify that site-specific conditions reflect the conditions and assumptions of the generic model underlying the VISLs, which are summarized in Section 6.5.2. To verify that the generic vapor intrusion model applies, there is a need for basic knowledge of the subsurface source of vapors (e.g., location, form, and extent of site-specific vapor-forming chemicals) and subsurface conditions (e.g., soil type in the vadose zone, depth to groundwater for groundwater sources), which are important elements of the CSM (see Section 5.4). When these subsurface data are not available, EPA recommends they be collected (i.e., initiate a vapor intrusion investigation; see Section 6.3.2, for example) before relying upon risk-based screening using pre-existing sampling data.

### 5.5.3 Preliminary Risk-based Screening

If reliable pre-existing sampling data are available and an adequate CSM has been developed (i.e., sufficient subsurface characterization information exists to adequately characterize the locations, forms, and extent of site-specific vapor-forming chemicals and general subsurface conditions (e.g., hydrologic and geologic setting in and around the source(s) and the buildings)), then a risk-based screening may be useful to obtain some preliminary insights about the potential level of exposure and risk posed by vapor intrusion.

*Example: A prospective developer of a vacant lot with no history of onsite chemical use is interested in evaluating the potential for vapor intrusion in the future due to potential migration onto the lot of a plume of contaminated groundwater emanating from another property. The extent and nature of this off-property plume have been adequately and recently characterized and geologic conditions near (but not on) the lot have been characterized, as documented in a publicly available report(s). In this circumstance, it may be possible to support a preliminary screening and obtain some useful insights. For example, if the maximum concentration of each chemical of concern in the off-property plume of contaminated groundwater currently and in the future is less than the generic chemical-specific screening level for groundwater, then vapor intrusion may not be a future*

---

<sup>98</sup> EPA recommends basing the decision about whether to undertake response action for vapor intrusion (i.e., a component of risk management; see Section 7.4) on a consideration of a reasonable maximum exposure (e.g., EPA 1989, 1991a), which is intended to be a semi-quantitative phrase, referring to the lower portion of the high end of the exposure distribution (see Glossary).

*concern on the vacant lot, provided there are sufficient data to document that conditions on the vacant lot are consistent with the generic model behind the vapor intrusion screening levels, as described in Section 6.5.2.*

*Depending upon lot-specific circumstances, additional data collection or evaluation, possibly including on-lot site characterization, may be warranted (i.e., proceed to a detailed vapor intrusion investigation) to verify that the expected conditions hold true (e.g., hydrogeologic conditions on the vacant lot are consistent with the generic model behind the vapor intrusion screening levels). EPA generally also recommends consideration of the vapor intrusion pathway during the development planning or initial post-construction stage (e.g., pre-emptive mitigation – Sections 3.3 and 7.8; mathematical modeling, where parameters are chosen to represent conditions that give a high-impact case – Section 6.6; indoor air testing – Section 6.4.1 -- to confirm the screening results based upon the groundwater source data) before making final risk management decisions.*

This example reinforces the following general recommended guidelines:

- EPA generally recommends that site-specific data be collected and evaluated to verify that the subject property reflects the conditions and assumptions of the generic model underlying the VISLs (see Section 6.5.2).
- EPA generally recommends that multiple lines of evidence (e.g., hydrogeologic information in addition to sampling data) be collected and weighed together in supporting assessments of the vapor intrusion pathway (see Sections 7.1, 7.2, and 7.3 for further information).
- Multiple rounds of groundwater (or soil gas) sampling results can be useful in supporting conclusions that a specific vapor source is stable or shrinking and/or is not expected to pose a vapor intrusion concern (see Sections 6.3.1 and 6.4.5) under reasonably expected future, as well as current, conditions.

Similar recommended guidelines may be appropriate in situations where vapor intrusion potential is being evaluated as part of a periodic review of an existing remedy (prompted, for example, by recent construction of a new building over a contaminated plume that is undergoing remediation) (EPA 2002b, 2012c).

## 6.0 DETAILED INVESTIGATION OF VAPOR INTRUSION

EPA recommends that the planning and data review team plan and conduct a site investigation for vapor intrusion when the preliminary analysis (Section 5.3) indicates the presence of subsurface contamination with vapor-forming chemicals underlying or near buildings.

This section describes EPA's generally recommended approaches and practices for conducting detailed vapor intrusion investigations, which typically entail collecting and weighing multiple lines of evidence to characterize the vapor intrusion pathway. Specifically, this section:

- Identifies that a wide variety of scenarios may be encountered among sites investigated for potential vapor intrusion, which necessitates site-specific approaches to scoping investigations and sequencing investigation phases and objectives (Section 6.1);
- Provides EPA's recommendations for planning, scoping, and conducting vapor intrusion investigations (Sections 6.2, 6.3, and 6.4);
- Presents EPA's recommended screening levels for vapor intrusion and describes EPA's recommended uses of risk-based screening and suggested interpretation of the results (Section 6.5); and
- Provides recommendations for developing and using mathematical models in vapor intrusion assessments (Section 6.6).

Section 7 describes EPA's generally recommended approaches and practices for determining, on the basis of the investigation results, whether the vapor intrusion pathway poses a potential human health risk to building occupants under current and reasonably expected future conditions and whether response actions are warranted for vapor intrusion mitigation at individual facilities, buildings, or sites.

### 6.1 Common Vapor Intrusion Scenarios

Vapor intrusion scenarios can be quite varied, owing to the possible combinations of:

- Multiple hazardous chemicals that can form vapors.
- Multiple forms in which these chemicals may be released to or present as contaminants in the subsurface, for example:
  - Residual NAPL and adsorbed-phase chemicals, including LNAPLs that are less dense than water and DNAPLs that are denser than water.
  - Dissolved-phase chemicals in groundwater or soil moisture.
  - Primary vapor releases (e.g., from chemical vapor transmission lines).
- The variety of geologic and hydrologic characteristics and conditions in the subsurface environment in which this contamination may occur.

- The variety of buildings (in terms of size, age, condition, and use) and current or expected land use settings (e.g., residential, commercial, industrial) that may be subject to vapor intrusion from such subsurface contamination.
- Circumstances under which subsurface contamination is found or suspected and investigated (e.g., brownfield redevelopment, citizen reports/complaints, reported release)
- The variety of sources that may contribute to vapor concentrations in ambient air and may serve as indoor vapor sources unrelated to vapor intrusion.

A few of the possible scenarios are illustrated in Figure 2-1. Many more can be inferred from the conceptual model of vapor intrusion discussed in Section 2. Some of the common scenarios where vapor intrusion has been documented to occur include:

- Groundwater contaminant plumes in shallow aquifers underlying residential and nonresidential buildings. Many well-known vapor intrusion sites are in this category, in part because there is generally a greater opportunity to have multiple buildings overlying the vapor source. Specific sites and buildings normally can be prioritized and distinguished based upon their potential for vapor intrusion, which generally would depend upon a number of site-specific factors, such as:
  - strength, proximity, and extent of the vapor source emanating from shallow groundwater (see Sections 2.1 and 5.4);
  - the potential for significant attenuation of vapor migration due to geologic, hydrologic, or biochemical conditions in the vadose zone (see Sections 2.2 and 5.4);
  - the potential for significant attenuation of the contaminant plume due to geologic, hydrologic, or biochemical conditions in the saturated zone; and
  - type(s), characteristics and structural condition of the overlying building(s) (see Sections 2.3, 2.4, and 5.4).
- Soil contamination in the vadose zone underlying commercial or industrial buildings. Typically, one or a few buildings may be threatened by potential vapor intrusion. Specific buildings and sites normally can be prioritized and distinguished based upon their potential for vapor intrusion, which generally would depend upon a number of site-specific factors, such as:
  - strength, proximity, and extent of the vadose zone source (see Sections 2.1 and 5.4);
  - the potential for attenuation of vapor migration due to geologic, hydrologic, or biochemical conditions in the vadose zone (see Sections 2.2 and 5.4); and
  - type(s), characteristics and structural condition of the overlying building(s) (see Sections 2.3, 2.4, and 5.4).

- Sites with residual wastes (e.g., landfills, former manufactured gas plants, former oil production fields) underlying or near buildings. The potential for methane formation may more frequently warrant additional consideration for sites with residual wastes than for contaminated groundwater plumes.

EPA's recommended approaches and practices for vapor intrusion investigations aim to be flexible and adaptable to a wide range of reasonably expected scenarios and are not intended to be prescriptive or exhaustive for any specific scenario.

## 6.2 Planning and Scoping

Before information or data are collected, EPA generally recommends conducting systematic and thorough planning during which performance or acceptance criteria are developed for the collection, evaluation, or use of these data (EPA 2006a).<sup>99</sup> EPA recommends the data quality objective (DQO) process as the appropriate systematic planning process for its decision-making and has issued guidance for its application to hazardous waste site investigations pursuant to CERCLA and RCRA (EPA 2000a).<sup>100</sup> When appropriately conducted, planning provides greater assurance that the data collected will fulfill specific project needs and that mitigation and subsurface remediation options will be considered early in the process.<sup>101</sup> A clear and logical plan will often facilitate communication with building owners, occupants, and other stakeholders.

Given these considerations, a thorough planning process, guided by a CSM, is usually advisable for detailed vapor intrusion investigations. Figure 6-1 provides a diagram to illustrate such planning and scoping. The initial stages of planning would typically entail gathering readily available existing information and formulating an initial CSM, as described in Section 5.4. The CSM portrays the current understanding of site-specific conditions, including the nature and extent of contamination, contaminant fate and transport routes, potential "receptors" and contaminant exposure pathways. The term "conceptual" merely reflects that the model need not be entirely quantitative and mathematical; it does not, however, denote a simplistic or incomplete understanding of site conditions. The CSM normally warrants updating as new information is developed and new investigatory questions are framed and answered.

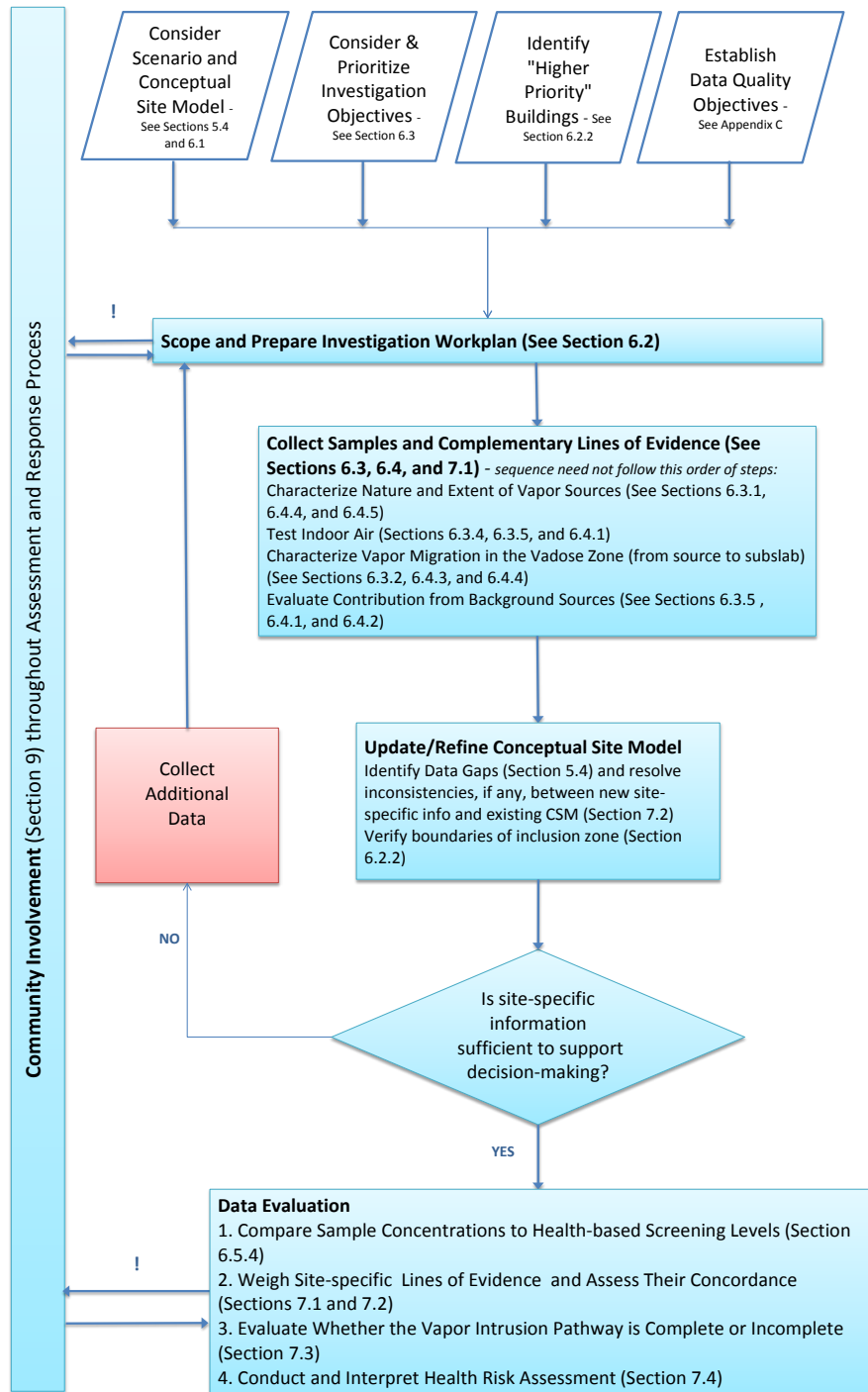
Subsequent to formulating an initial CSM based on readily available information, the scope for an initial phase of vapor intrusion investigation would be developed, preferably along with a logical plan for future directions in response to the reasonably expected outcomes of the initial investigatory phases and in coordination with the objectives and phasing of the broader site

---

<sup>99</sup> In situations where imminent threats (see Section 5.2) are known or reasonably expected, the initial planning process may be more truncated and focused, but careful and thoughtful planning is still recommended.

<sup>100</sup> Appendix B provides additional information about EPA's quality system and DQO process.

<sup>101</sup> *Science and Decisions: Advancing Risk Assessment* was prepared by the National Academy of Sciences (NAS) Committee on Improving Risk Analysis Approaches Used by the U.S. EPA (NRC 2009) and is commonly referred to as the "Silver Book." Among other recommendations, the NAS Committee encouraged EPA to focus greater attention on design in the formative stages of risk assessment, specifically on planning and scoping and problem formulation, and to view risk assessments as a method for evaluating the relative merits of various options for managing risk, rather than as an end in itself. Consistent with these recommendations, plausible mitigation and subsurface remediation options (see Section 8) may warrant consideration during development of vapor intrusion investigation plans.



Exclamation point (!) indicates important milestone for communication and engagement efforts with affected building occupants and owners.

Figure 6-1 Overview of Planning, Scoping, and Conducting Vapor Intrusion Investigations

characterization. Initial plans may warrant periodic updates and refinements, particularly when data outcomes are unexpected and prompt the need to reevaluate the CSM. In each case, EPA recommends that the investigation work plan include the identification of and basis for the indoor air screening levels (such as the vapor intrusion screening levels (VISLs)) and/or indoor air action levels (i.e., level of each vapor-forming chemical of potential concern that would trigger a response action if exceeded), which would dictate the DQOs for the sampling and analysis methods. In general, EPA recommends the plan also include a rationale or logic for where and how the data will be collected and over what duration(s), how the data will be interpreted (e.g., weighed with other lines of evidence, compared to risk-based benchmarks), whether confirmatory sampling will be needed if all sample concentrations are less than the action levels, whether response action(s) would be triggered if sample concentrations exceed the target levels, and similar considerations. EPA recommends considering potential health effects and relevant exposure periods (e.g., chronic versus short-term effects and exposure durations and scenarios; see Section 7.4) for site-related, vapor-forming chemicals when developing DQOs and sampling plans for indoor air (see Section 6.4.1, for example). Sections 6.3 through 6.6 below provide additional information for planning and scoping site-specific investigations for vapor intrusion assessment.

EPA's fundamental approach to evaluating contaminated sites calls for proceeding in a stepwise fashion with early data collection efforts usually limited to developing a basic understanding of the site, as reflected in the CSM.<sup>102</sup> Subsequent data collection efforts focus on filling gaps in the understanding of the CSM and gathering information necessary to evaluate the relative merits of various options for managing risk. Therefore, EPA generally recommends developing and implementing an overall vapor intrusion investigation plan in multiple stages or phases. Such a phased approach encourages the identification of key data needs early in the process to better ensure that data collection provides information relevant to decision-making (e.g., interim action to mitigate vapor intrusion and selection of a cleanup plan for subsurface contamination). In this way, the overall site characterization effort can be scoped to prioritize data collection and minimize the collection of unnecessary data and maximize data quality.

EPA recommends that the objectives and methods of the investigation be documented, preferably in a vapor intrusion work plan. An individual work plan may address a single phase or stage or may address the overall investigation. The vapor intrusion work plan(s) may be

---

<sup>102</sup> Investigations under CERCLA and RCRA corrective action (CA) explicitly recognize phasing. In these cleanup programs, the first investigatory phase is an *initial site assessment*. The purpose of this activity is to gather information on site conditions (current and historical), releases, potential releases, and exposure pathways. Investigators use this information to determine whether a response action (e.g., removal action or interim cleanup measure) may be needed or to identify areas of concern for further study. Information collected during this phase usually forms the basis for determining whether the next stage, site investigation, is warranted. In the RCRA CA program, the initial site assessment is called the RCRA facility assessment. Under CERCLA, this phase is called the preliminary assessment/site inspection. The purpose of the second phase, site investigation, is to determine the nature and extent of contamination at a site, quantify risks posed to human health and the environment, and gather information to support the selection and implementation of appropriate remedies. In the RCRA CA program, this phase is known as the RCRA facility investigation. Under the CERCLA remedial program, this phase is referred to as the remedial investigation. In addition, the site investigation may itself be conducted in multiple stages (or phases).

incorporated as part of a comprehensive site investigation work plan or as a stand-alone document, depending upon site-specific circumstances.<sup>103</sup>

At a minimum, EPA recommends that the components of the work plan(s) include or reference:

- Narrative description of the rationale, objective(s), and scope of the investigation.
- Summary of the CSM, based upon the current understanding of site conditions.
- Scaled map(s) illustrating known extent of subsurface contamination and readily identifiable landmarks (e.g., streets and buildings).
- Media to be sampled.
- Number, type, and location of and rationale for proposed sampling locations.
- Sampling methods and procedures for each medium.
- Analytic method(s) to be used to obtain chemical concentrations and a statement about whether a stationary or mobile laboratory will be used.
- Standard operating procedures of the laboratory and for field instruments.
- Quality assurance project plan (QAPP).
- Health and safety plan.<sup>104</sup>

EPA recommends that planning for vapor intrusion investigations also consider site and building access agreements, equipment security, and locations of underground utilities.

EPA recommends that the planning, data collection, and data review team(s) for vapor intrusion investigations generally include:

- Individuals with expertise in characterizing subsurface environmental conditions and interpreting and communicating environmental data.
- On-site (field) personnel with appropriate training and experience in hazard identification, workplace practices to foster health and safety, and recommended sampling protocols.

---

<sup>103</sup> EPA recommends that monitoring programs (see Section 8.4) that assess the performance and effectiveness of remediation and mitigation systems (see Sections 8.1 and 8.2, respectively) also be documented, preferably in work plans similar to those recommended herein for characterizing and assessing the vapor intrusion pathway.

<sup>104</sup> All governmental agencies and private employers are directly responsible for the health and safety of their employees. This general rule applies to many parties involved in the assessment and cleanup of Superfund sites, RCRA corrective action sites, and brownfield redevelopment sites. Standards established pursuant to the Occupational Safety and Health Act are found in Title 29 of the Code of Federal Regulations (29 CFR), which include standards for training, hazard communication, and site-specific health and safety plans.



- Individuals with expertise in human health risk assessment to characterize risks posed by the vapor intrusion pathway.
- Individuals with expertise in community involvement and outreach.

Depending upon the complexity of the CSM (see Section 5.4) and site-specific data evaluations, decision-makers may also find valuable input from individuals with expertise in hydrogeology, inferential statistics, laboratory analysis methods, and building construction, ventilation, and operations and individuals knowledgeable about land use planning, zoning, and land development.

EPA recommends that the scope of investigations within buildings and on individual properties be contemplated, planned, and implemented with the goal of limiting, to the extent practical, return visits, which can cause disruption and inconvenience for building occupants and owners. For example, it may be preferable to collect a comprehensive set of data (e.g., indoor air, sub-slab soil gas, and ambient air samples; pressure readings; see Section 6.4) and confirm information about building occupancy, building usage, heating, cooling, and ventilation (see Section 6.4.1) in a single mobilization, rather than over separate visits, when the investigation objectives include indoor air sampling (see Section 6.3.4) or evaluating contributions of 'background' sources on levels of vapor-forming chemicals in indoor air (see Section 6.3.5).

### 6.2.1 Vapor Intrusion Inclusion Zones

Soil gas concentrations generally decrease with increasing distance from a subsurface vapor source, and eventually at some distance the concentrations become negligible. The distance at which soil gas concentrations become negligible is a function of the strength and dimensions of the vapor source, the type of vapor source, the soil types and layering in the vadose zone, the presence of physical barriers (e.g., asphalt covers or ice) at the ground surface, and the presence of preferential migration routes, among other factors (see, for example, EPA 2012b). The extent of the site-specific "inclusion zone" for vapor intrusion may also expand in the future, depending upon:

- The age of the chemical release and whether sufficient time has elapsed to allow soil gas to migrate from the source to its maximum potential extent.<sup>105</sup>
- Whether the subsurface vapor source is expanding (i.e., is migrating) or rising in concentration, including hazardous byproducts of any biodegradation.

Because these factors vary among sites, the distance beyond which structures will not be affected by vapor intrusion should be a site-specific determination.

**Recommended Distance for Initial Evaluation.** There are limited published empirical data relating observed indoor air concentrations of subsurface contaminants to distance from a well-

---

<sup>105</sup> EPA (2012b, Section 6.1) presents some information about transient vapor migration after a subsurface vapor source is released. Sites with shallow vapor sources (e.g., less than one meter deep) may take only a few hours to a few days for soil gas to migrate to its maximum potential extent. Sites with deeper vapor sources (e.g., greater than 10 meters deep) may take months or years for soil gas to migrate to its maximum potential extent.

defined source boundary. However, a buffer zone of approximately 100 feet (laterally or vertically from the “boundary” of subsurface vapor concentrations of potential concern) generally has been used in determining which buildings to include in vapor intrusion investigations (i.e., which buildings are ‘near’ a subsurface vapor source for purposes of a preliminary analysis) when significant surface covers are not present, under the assumption that preferential vapor migration routes are absent.<sup>106</sup> Specifically, a buffer zone of 100 feet (or approximately two houses wide) has been suggested by several states for initial evaluation and is supported, in general, by:

- theoretical analyses that assume the absence of a preferential vapor migration route(s) and that diffusion is the predominant mechanism of vapor migration in the vadose zone (Lowell and Eklund 2004); and
- reports that vapor intrusion impacts generally have not been observed “at distances greater than one or two houses beyond the estimated extent of the groundwater plume”, at sites where contaminated groundwater is the subsurface vapor source (Folkes et al. 2009).

However, we would note that vapor source types for which use of a 100-foot buffer would typically be inappropriate include:

- Landfills where methane is generated in sufficient quantities to induce advective transport in the vadose zone.<sup>107</sup>
- Commercial or industrial settings where a vapor-forming chemical(s) has been released within an enclosed space at a density that may result in significant advective transport of the vapor(s) downward through cracks or openings in floors and into the vadose zone.
- Leaking vapors from pressurized gas transmission lines.

In each of these cases, the diffusive transport of vapors may be overridden by advective transport and the vapors may be transported in the vadose zone several hundred feet from the source of contamination.<sup>108</sup>

Moreover, we would also note that anecdotal evidence indicates that in some settings buildings greater than 100 feet from a plume “boundary” are affected by vapor intrusion, even when

---

<sup>106</sup> Preferential migration routes are defined and discussed in Section 5.4. When present, they may facilitate subsurface vapor migration over distances greater than 100 feet.

<sup>107</sup> EPA has also published *Guidance for Evaluating Landfill Gas Emissions from Closed or Abandoned Facilities* (EPA 2005), which provides procedures and a set of tools for evaluating landfill gas emissions to ambient air and soil gas migration due to pressure gradients.

<sup>108</sup> For example, Little et al (1992) describe a landfill in southern California, where methane was detected in enclosed spaces in nearby homes at concentrations approaching 1% by volume and chlorinated hydrocarbons had migrated into a house 180 meters from the landfill.

diffusion is the presumed mechanism of vapor migration.<sup>109</sup> Furthermore, the presence of conduits (e.g., sewer and drain lines that intercept and carry subsurface contamination (Vrobley et al. 2011), as well as permeable bedding for sewer lines or other utilities) or preferential hydrogeologic pathways that facilitate unattenuated vapor migration in the vadose zone, and other factors (e.g., presence of extensive surface covers, uncertainties in delineating the boundaries) may extend the recommended inclusion distance for a vapor intrusion investigation. For these reasons, EPA recommends investigating soil vapor migration distance on a site-specific basis. That is, larger or smaller distances may need to be considered when developing objectives for detailed vapor intrusion investigations and interpreting the resulting data. Data from sub-slab and exterior soil gas sampling (see, for example, Sections 6.4.3, and 6.4.4, respectively)<sup>110</sup> and indoor air testing (see, for example, Sections 6.3.4 and 6.4.1) can be collected and evaluated to delineate or confirm areas at specific sites within which buildings are potentially subject to vapor intrusion.

Criteria for Establishing “Boundaries” of the Plumes that Contain Vapor-forming Chemicals. This Technical Guide is intended to be applied to existing groundwater plumes as they are currently defined (e.g., Maximum Contaminant Levels, state standards, or risk-based concentrations). However, it is important to recognize that some non-potable aquifers may have plumes that have been defined by threshold concentrations significantly higher than drinking-water concentrations. In these cases, contamination that is not technically considered part of the plume may still have the potential to pose unacceptable human health risk via the vapor intrusion pathway. Consequently, the plume definition may need to be expanded for purposes of defining an inclusion zone for a vapor intrusion investigation. When groundwater is the subsurface vapor source, EPA generally recommends comparing groundwater concentrations to the VISLs to estimate the boundaries of the plume, when contaminated groundwater is a subsurface vapor source, for purposes of establishing the boundaries of the vapor intrusion inclusion zone.

Criteria for Establishing “Boundaries” of NAPL Plumes that Contain Vapor-forming Chemicals. EPA generally recommends comparing soil gas concentrations to the respective VISLs to estimate the boundaries of the vapor plume, when residual or free-phase NAPL is a subsurface vapor source, for purposes of establishing the boundaries of the vapor intrusion inclusion zone.

## 6.2.2 Prioritizing Investigations with Multiple Buildings

At sites where numerous buildings are potentially subject to vapor intrusion (e.g., developed areas with an extensive plume of contaminated groundwater), it may not be feasible or practical at the outset to sample indoor air in each building or soil gas underneath or near each building. In such circumstances, EPA generally recommends a “worst first” approach to prioritize

---

<sup>109</sup> Among other possibilities, vapor intrusion impacts observed to occur at distances greater than 100 feet in the absence of a preferential migration route(s) may reflect imprecision in the interpolated edge of a plume, based upon sampling data from sparse monitoring wells, and/or use of screening levels for drinking water, rather than for vapor intrusion (i.e., VISLs), to delineate a plume’s extent.

<sup>110</sup> For assessing the extent of soil gas migration from the subsurface vapor source, EPA generally recommends measuring soil gas concentrations, either sub-slab soil gas (preferably) or exterior soil gas, with a sufficient density to characterize and understand spatial variability (Section 6.3.2).

buildings for investigation. Factors that, if known, may warrant consideration in prioritizing buildings for investigation include:

- Source strength and proximity. Buildings overlying and near a source of vapors in the vadose zone would generally be expected to have a greater potential for vapor intrusion than buildings that do not overlie this same vapor source. Where the subsurface vapor source is groundwater, buildings located over higher concentrations or shallower water levels would generally be expected to have a greater potential for vapor intrusion than buildings located over lower concentrations and deeper groundwater plumes.
- Building types and conditions. Buildings that are continuously occupied may pose a more immediate concern than buildings that are not currently occupied, if all other factors (e.g., source strength and proximity) are equivalent. Nonresidential buildings with bay-style doors that are routinely open may be better ventilated than other types of nonresidential buildings, providing greater potential for dilution of vapor-forming chemicals that enter the building via vapor intrusion.
- Vapor migration ease. Buildings overlying vadose zones comprised of coarse geological materials (e.g., gravel, boulders) generally would be expected to have a greater potential for vapor intrusion than buildings overlying vadose zones comprised of fine-grained materials (e.g., silts, clays), provided significant preferential migration routes (e.g., geologic fractures, utility corridors) are not present in the fine-grained layers.

Interviews and building surveys during development of the investigation work plan (or during the preliminary analysis – see Section 5) also can provide useful information for prioritizing buildings, when phased testing is chosen or indicated. Sections 6.3 and 6.4 provide additional examples of survey information that can support planning, in addition to supporting data interpretation.

In situations where “higher-priority” buildings and locations are investigated initially, investigation of locations of other buildings may still be warranted, for example, to ensure that the CSM is complete and accurate and that variability in the subsurface conditions and building conditions is understood. There usually is substantial spatial variability in the concentrations of subsurface vapors, caused by heterogeneities in the subsurface materials and other factors, that can result in variability among buildings in vapor flux and indoor air concentrations arising from vapor intrusion. Additionally, building construction, building age and maintenance, and occupants’ activities that affect soil gas entry and air exchange rate will vary from building to building, further adding to the variability in indoor air concentrations between buildings. Therefore, it may be difficult to identify *a priori* either a “representative” or “reasonable worst case”<sup>111</sup> building or group of buildings, when it is determined that sampling all buildings is not practical.

---

<sup>111</sup> For purposes of this Technical Guide, “reasonable worst case” is intended to be a semi-quantitative phrase, referring to the upper portion of the high end of the exposure distribution, but less than the absolute maximum exposure (see Glossary). Because EPA generally recommends a “worst first” approach to prioritize buildings for investigation of the vapor intrusion pathway, “reasonable worst case” buildings would warrant a “higher priority” than “representative” or typical buildings.

When sampling all buildings is not practical, but other lines of evidence suggest that vapor intrusion may be occurring, the site management team may wish to consider installing engineered exposure controls for vapor intrusion mitigation in buildings without baseline indoor air data (i.e., building mitigation as an early action – see Sections 3.3 and 7.8).

### 6.2.3 Planning for Community Involvement

Community involvement is an important component of any vapor intrusion investigation. EPA recommends that a community involvement or public participation plan (see Section 9.1) be developed or refined while planning a vapor intrusion investigation. Proper and sustained community outreach and engagement efforts are critical to effectively implementing work plans for vapor intrusion investigations, particularly when they involve sampling in a home or workplace or on private property. Resuming and conducting community involvement at legacy sites (i.e., sites that have a past history of agency involvement; see Section 9.6) can be particularly complex. The site planning team is encouraged to consult with appropriate EPA colleagues experienced in community outreach and involvement efforts and utilize available EPA planning resources, including those discussed in Section 9.

## 6.3 Characterize the Vapor Intrusion Pathway

As discussed in Section 2, the vapor intrusion pathway entails emanation of volatile chemicals from a subsurface source(s) in a vapor form that migrates in the vadose zone, gradually increases in amount underneath buildings as time passes, and enters buildings through openings and conduits. As a result, detailed vapor intrusion investigations designed to develop or enhance the CSM for a specific site will typically address one or more of the following objectives, often in phases:<sup>112</sup>

- Characterize the nature and extent of subsurface sources of vapors.
- Characterize the subsurface migration paths between vapor sources and buildings (potential “receptors”).
- Assess building(s) for their susceptibility to soil gas entry.
- Evaluate the presence and concentration of a site-related subsurface contaminant(s) in indoor air.
- Identify and evaluate contributions of indoor and ambient air sources to concentrations of hazardous vapors in indoor air.

---

<sup>112</sup> The order of presentation is not intended to convey a suggested sequencing of objectives; rather, it follows the presentation of the conceptual model of vapor intrusion in Section 2.

These objectives are described in the following subsections for purposes of identifying the primary lines of evidence typically developed and evaluated for each objective and describing how the objectives fit together in developing and enhancing the CSM for a specific site and characterizing vapor intrusion potential. This information is provided to assist the site planning team in selecting and sequencing objectives for vapor intrusion investigations.

### 6.3.1 Characterize Nature and Extent of Subsurface Vapor Sources

Where the preliminary analysis indicates that subsurface contamination with vapor-forming chemicals may be underlying or near buildings, EPA recommends that the nature and extent of such contamination be well characterized. Source characterization data are critical to developing a sound CSM and supporting confident, final decisions about the vapor intrusion pathway.

Investigations to characterize the nature and delineate the extent of potential sources of vapors may rely upon the results of groundwater sampling, soil sampling, or soil gas sampling, as dictated by the site-specific source(s) and subsurface conditions.

### **Groundwater Sources:**

Where contaminated groundwater is a vapor source located near buildings, EPA recommends that groundwater observation wells (i.e., monitoring wells) be installed at strategic locations and used to assess groundwater flow and contaminant concentrations; i.e., verify the nature and extent of groundwater contamination through groundwater sampling and analysis.<sup>113</sup> Groundwater samples obtained from the uppermost portion of the aquifer<sup>114</sup> that underlies the study area of interest (i.e., where buildings are located) are recommended for characterizing representative vapor source concentrations for vapor intrusion assessment. For this purpose, wells (or multi-level samplers) that are screened across the water table interface are preferred and EPA recommends samples be collected as close as possible to the top of the water table using approved sampling methods designed to minimize loss of volatiles while sampling (EPA 2002a, EPA-ERT 2001a).<sup>115</sup> Ideally, the plume can be shown as stable or shrinking (i.e., is not migrating or rising in concentration, including hazardous byproducts of any biodegradation), through multiple rounds of sampling, so that vapor source concentrations can be confidently evaluated under reasonably expected future, as well as current, conditions. Otherwise, the inclusion zone for vapor intrusion (see Section 6.2.1) may expand over time and/or current sample concentrations in or beneath a given building may under-estimate the reasonable maximum vapor intrusion condition in the future.

For purposes of assessing vapor intrusion for specific buildings, groundwater samples from wells nearer to buildings are generally recommended over those from more distant wells. Interpolation of the results obtained from two or more wells in the uppermost portion of the aquifer may be warranted for these purposes when the spatial pattern suggests significant lateral gradients in contaminant concentrations within the area of interest. However, for purposes of determining whether contaminated groundwater poses acceptable human health risk from vapor intrusion on an area-wide basis, it may be more appropriate to utilize sampling results for the most greatly impacted well within the area of interest.

In addition, EPA generally recommends that a soil gas sample be collected immediately above the groundwater table (and above the capillary fringe) (i.e., “near-source” soil gas sample)<sup>116</sup> to help characterize the subsurface vapor source. The results of such “near

---

<sup>113</sup> Although a soil gas survey can also be employed as a screening tool to assist with the delineation of a plume of contaminated groundwater, EPA recommends that plume delineation ultimately be supported by the collection and analysis of confirmatory groundwater samples at appropriate locations.

<sup>114</sup> EPA recommends that, to the extent practical, groundwater samples be collected over a narrow interval (e.g., a few feet or less) just below the water table when the data are to be used for assessing the potential for vapor intrusion. Of course, the broader objectives of a site characterization will generally necessitate installation and sampling of additional wells, from other depth intervals, to accurately characterize the full nature and extent of groundwater contamination. Such wells and the broader topic of site characterization are not discussed in this Technical Guide, which is focused instead on recommended guidelines that are pertinent specifically to vapor intrusion.

<sup>115</sup> If available groundwater data do not meet these criteria, the site data review team may consider whether they are nevertheless representative of potential vapor source concentrations emanating from groundwater.

<sup>116</sup> In this context and for purposes of this Technical Guide, “near” means “within a practically short distance.” Site- and location-specific circumstances and project-specific objectives typically will influence the quantitative definition of “near” for purposes of collecting “near-source” soil gas samples.

source” soil gas samples can be compared to calculations of the vapor concentration expected when the soil gas is in equilibrium with the concentrations measured in shallow groundwater (see Appendix C). A favorable comparison (i.e., the two concentrations are equivalent for each vapor-forming chemical in groundwater) would help to support the results of the groundwater characterization. On the other hand, a “fresh water lens” (or other site-specific conditions; see, for example, Section 6.3.2) could account for measured soil gas concentration(s) being significantly lower than the calculated equilibrium concentration(s).

Because fluctuations in water table elevation can lead to elevated vapor concentrations in the vadose zone, EPA also recommends that “near source” soil gas sampling (and possibly a soil gas survey) be considered in different seasons that coincide with groundwater fluctuations.

### **Vadose Zone Sources:**

Where contaminated soil or non-aqueous-phase liquid (NAPL) in the vadose zone is a subsurface vapor source, soil sampling using coring techniques for sample retrieval or using sensors, such as a membrane interface probe, can be used to characterize the chemical composition and general location of contamination; that is, bulk soil concentration data can be used in a qualitative sense for this purpose. For example, high soil concentrations generally would indicate impacted soil. Unfortunately, the converse is not always true. Non-detect results for soil samples cannot be interpreted to indicate the absence of a subsurface vapor source, because of the potential for vapor loss due to volatilization during soil sampling, preservation, and chemical analysis.

Alternatively or in addition, a soil gas survey can be used to locate the primary source zone and delineate the areal and vertical extent of the vapor-affected area. Generally, EPA recommends that the soil gas survey include a soil gas sample collected immediately above each contaminant source in the vadose zone (i.e., “near-source” soil gas samples) to help characterize the vapor source.

Although a soil gas survey can generally be used to characterize many other subsurface vapor sources (e.g., sewer and drain lines; landfills and other land-based disposal units; impoundments and other land-based storage and/or treatment units, pressurized tanks and pipelines), additional approaches tailored to the specific source type may also warrant consideration.

These sampling options are generally coupled with an understanding of the site-specific subsurface conditions that control the location and extent of contamination (e.g., geologic properties, including stratigraphy and level of heterogeneity; hydrogeologic conditions; sewers, drains, and other conduits that lie underneath or intersect areas of groundwater and soil contamination). Such understanding is generally developed by interpreting the data obtained through borehole logging (i.e., visually inspecting soil cores and determining soil texture) or geophysical tools.

EPA generally recommends sample locations be of sufficient density to adequately account for spatial variability and heterogeneity in subsurface conditions. EPA generally recommends consulting with individuals who have expertise in characterizing subsurface environmental conditions (e.g., a geologist) when determining appropriate sampling locations and spacing.



When combined with the data demonstrating that the property reflects the conditions and assumptions of the generic model invoked in the VISLs (see Section 6.5.2), groundwater and “near-source” soil gas samples can be compared to medium-specific screening levels to develop an initial quantitative perspective about the potential level of exposure and human health risk posed by vapor intrusion. Section 6.5 provides additional information about risk-based screening of vapor source concentrations.

### 6.3.2 Characterize Vapor Migration in the Vadose Zone

As described in Section 2, geologic, hydrologic, biochemical factors in the vadose zone, as well as elapsed time since the environmental release, can influence vapor migration and attenuation in soil gas concentrations between subsurface vapor sources and nearby building(s).<sup>117</sup> As noted in Section 5.4, EPA recommends the CSM portray the current understanding of these vadose zone conditions in and around the subsurface vapor source(s) and nearby building(s). Furthermore, EPA recommends the CSM identify known or suspected preferential migration routes that could facilitate vapor migration to greater distances and at higher concentrations than otherwise expected. When these conditions are not well established from existing information, EPA recommends that a detailed investigation be scoped to address these data gaps.

When combined with other data, as discussed further in Section 7.3, information about subsurface vapor migration can support determinations that the vapor intrusion pathway is complete under current conditions or may be complete under future conditions. In some cases, vadose zone conditions may impose sufficient resistance to vapor migration to make the vapor intrusion pathway insignificant. In these circumstances, information about subsurface vapor migration, combined with other lines of evidence, can support determinations that the vapor intrusion pathway is incomplete under current conditions, as discussed further in Section 7.3.

Investigations seeking to characterize vapor migration in the vadose zone generally entail, at a minimum, a soil gas survey. Because soil gas concentrations can exhibit considerable spatial variability, due to a variety of factors,<sup>118</sup> EPA generally recommends that soil gas surveys collect soil gas samples at multiple locations and depth intervals between the vapor source and building(s) (potential “receptors”). As a result, the soil gas survey may include samples collected immediately outside the building (“exterior soil gas”) at various depths or several depth intervals,

---

<sup>117</sup> The horizontal and vertical distance over which vapors may migrate in the subsurface depends on the source concentration, source depth, soil matrix properties (e.g., porosity and moisture content), and time since the release occurred. For example, months or years of volatilization and vapor migration may be required to fully develop vapor distributions in the vadose zone at sites with deep vapor sources or with impedances to vapor migration arising from hydrologic or geologic conditions (Section 2.5; EPA 2012b). Under such circumstances, soil gas surveys conducted soon after an environmental release may not yield data indicating the maximum extent of vapor migration.

<sup>118</sup> Modeling of idealized scenarios provides additional demonstrations about spatial variability of soil gas concentrations. For example, vertical profiles of soil gas concentration(s) can be very different underneath buildings compared to locations exterior to the building and soil gas concentrations may not be uniform laterally, particularly in the vicinity of the building, even when the vapor source is a laterally extensive plume of contaminated groundwater (EPA 2012b). These simulation results indicate why EPA recommends that soil gas generally be sampled in multiple sampling locations, when assessing subsurface vapor migration routes.

as well as immediately beneath it (e.g., sub-slab soil gas sampling).<sup>119</sup> If any shallow soil gas samples are collected, EPA recommends they be collected as close as possible to the building and at depths below the respective building foundation and no less than five feet below ground surface, depending on site-specific conditions. Where crawl spaces are present, crawl space air sampling may also be conducted.

Generally, EPA recommends that the soil gas survey include a “near-source” soil gas sample collected immediately above each source of contamination to help characterize the subsurface vapor source (see Section 6.3.1). The results of such “near source” soil gas samples can be compared to calculations of the vapor concentration expected when the soil gas is in equilibrium with the concentrations measured in shallow groundwater (see Appendix C), when the subsurface vapor source is in the groundwater. Geologic, hydrologic, or biologic impedances to vapor migration may be indicated if the measured “near source” soil gas concentrations are significantly lower than the calculated equilibrium concentrations.

To characterize subsurface migration in the vadose zone, soil gas survey data are generally coupled with an understanding of the site-specific subsurface conditions that influence vapor migration and attenuation (e.g., geologic properties, including stratigraphy and level of heterogeneity; hydrologic conditions, including groundwater elevation and soil moisture;<sup>120</sup> and biological properties, including availability of oxygen to support aerobic biodegradation).<sup>121</sup> Such geologic understanding is generally developed by interpreting the data obtained through borehole logging and geophysical tools. Soil permeability to air flow can be measured in the field (McHugh et al. 2013) and would be used to corroborate inferences based upon borehole logging data. Hydrologic conditions can be characterized by analyzing soil samples for porosity and moisture content and by hydrologic modeling. For potentially biodegradable contaminants, an intensive soil gas survey to establish current vertical profiles for contaminant vapors and oxygen (and, in some cases, biodegradation products, such as carbon dioxide or methane)<sup>122</sup> may be able to demonstrate that biodegradation is responsible for attenuating vapor migration

---

<sup>119</sup> EPA recommends that spacing of soil gas sampling locations generally consider the extent and location of the subsurface vapor source, distance between the building and the source, and other site-specific factors.

<sup>120</sup> Tillman and Weaver (2007) conducted hydrologic modeling and collected field data, which showed that moisture content determined from soil cores taken external to a building may over-estimate soil moisture underneath the building. They inferred that vapor intrusion assessments based upon moisture content in soil from open areas between buildings may under-estimate vapor intrusion potential.

<sup>121</sup> As noted in Section 2, vapor migration in the vadose zone can be impeded by several factors, including soil moisture, low-permeability (generally fine-grained) soils, and biodegradation. Significant characterization of the vadose zone may be needed to demonstrate that such geologic, hydrologic, and biologic features are laterally extensive over distances that are large compared to the footprint of the building and the extent of the subsurface vapor source at a specific site.

<sup>122</sup> Interpretation of profiles for carbon dioxide and methane can be challenging, due to the presence of natural sources unrelated to contaminant biodegradation (Holden and Fierer 2005).

to a greater extent than can be attributed to advection and diffusion in the vadose zone.<sup>123, 124</sup> For both purposes, samples collected directly underneath the building will tend to be more representative of conditions influencing vapor intrusion potential than samples collected outside the building footprint, all else being equal.

When conducted contemporaneously for multiple buildings, a soil gas survey and characterization of the vadose zone can help identify distances from subsurface vapor sources beyond which threats from vapor intrusion are not reasonably expected, as mentioned in Section 6.2.1. At sites with a limited number of potentially affected buildings, it may be feasible to characterize the subsurface vapor migration near and surrounding all of them. However, at sites where a large number of buildings may be affected, this approach is not likely to be feasible; in these cases, EPA generally recommends that the site manager seek the advice of an individual familiar with the site-specific subsurface conditions (typically a geologist) to help guide selection of appropriate sampling locations and assess whether “representative” or “reasonable worst case” locations can be identified, as appropriate to the objectives of the investigation. Because there usually is substantial spatial variability in the concentrations of subsurface vapors, caused partially by heterogeneities in the subsurface materials, it may be difficult to identify *a priori* locations that are either “representative” or are “reasonable worst case” subsurface conditions.

Subsurface investigations of vapor intrusion also generally warrant an evaluation of utility corridors, which can facilitate unattenuated vapor transport over longer-than-anticipated distances and/or vapor migration towards and into buildings that are serviced by the utility. EPA also recommends subsurface investigations of vapor intrusion consider whether sewers and other man-made conduits have the potential to transport NAPLs, contaminated groundwater, and/or vapors (through soil) towards and/or directly into buildings. Public and facility records may be useful sources of information about utility and sewer locations, which may provide maps, “as built diagrams,” or construction specifications. Depending upon the CSM, sampling of vapors within the utility corridor (or within a sewer, if present) may be warranted to characterize vapor migration in the subsurface (or characterize a secondary source of vapors – see Sections 6.3.1 and Section 2.1).

Reasonably expected future risks posed by the subsurface vapor source(s) warrant consideration, in addition to risks posed under current conditions, “in order to demonstrate that a site does not present an unacceptable risk to human health and the environment” (EPA 1991a). For example, when evaluating subsurface vapor migration and attenuation in locations where buildings do not exist, it is important to recognize that the conditions in the vadose zone and soil

---

<sup>123</sup> At sites where aerobic biodegradation is limiting the upward migration of petroleum hydrocarbon vapors, for example, the vertical concentration profile will typically show higher concentrations of petroleum hydrocarbons and lower (or non-detect) concentrations of oxygen in deeper soil gas samples. At these same sites, the vertical concentration profile will typically show lower (or non-detect) concentrations of petroleum hydrocarbons and higher concentrations of oxygen in shallower soil gas samples. Because weather events can affect rates of oxygen replenishment in the vadose zone (Lundegard et al. 2008), multiple rounds of such sampling are recommended to demonstrate that biodegradation consistently poses a significant impediment to upward vapor migration. This recommendation is particularly apt where the subsurface vapor source is strong (e.g., unweathered NAPL in the vadose zone) relative to time-variable processes supplying oxygen to the vadose zone.

<sup>124</sup> In this context, mathematical modeling (see Section 6.6) can be employed to characterize vapor migration attributable to advection and diffusion in the vadose zone.

gas concentrations may be changed as a result of constructing a new building and/or supporting infrastructure. The moisture content may decrease and the moisture profile change in the vadose zone as a result of reduced infiltration of rainwater below a building footprint (Tilman and Weaver 2007). The permeability to vapor flow in the vadose zone may be altered in the foundation vicinity due to construction. Finally, the future presence of extensive surface covers and/or utility corridors may also modify the vertical and horizontal profile of soil gas concentrations in the subsurface (EPA 2012b). As a result, EPA recommends that appropriate lines of evidence in addition to a soil gas survey (e.g., mathematical modeling, where parameters are chosen to represent conditions that give a high-impact case – Section 6.6) be developed and considered to support any determination that a future building will not be subject to vapor intrusion or will not pose unacceptable human health risk for occupants. Owing to the potentially unpredictable plans for building construction and site redevelopment, as well as potentially unpredictable changes in the transitory soil characteristics (e.g., soil moisture) and soil gas concentrations, institutional controls may be warranted (e.g., to inform the need for a confirmatory evaluation of the vapor intrusion pathway) when new buildings are constructed in areas where the subsurface vapor source(s) has(have) significant potential to pose a vapor intrusion threat.

### 6.3.3 Assess Building Susceptibility to Soil Gas Entry

When elevated concentrations of vapor-forming chemicals accumulate in the soil gas immediately underneath the foundation, surrounding the basement, or within the crawl space of a vulnerable building, then soil gas entry (i.e., vapor intrusion) can lead to unacceptable levels of subsurface contaminants in indoor air, depending upon building- and site-specific circumstances. As discussed in Section 2.3, soil gas can enter a building when openings are present and driving ‘forces’ exist to draw the vapors from the subsurface through the openings into the indoor environment.

Single-family detached homes can generally be presumed to have openings for soil gas entry; as such, they will generally be susceptible to soil gas entry unless a mitigation system (e.g., radon mitigation system) is present and operating as intended. Some buildings are more susceptible to soil gas entry than others. For example, buildings with significant openings, such as:

- buildings with deteriorating basements or dirt floors, which generally provide poor barriers to vapor (soil gas) entry; and
- buildings with sumps (or other openings to the subsurface) that can facilitate transport of vapors via soil gas entry.

EPA recommends that appropriate lines of evidence be employed to assess susceptibility to soil gas entry, when this objective is selected as part of a site-specific investigation plan for vapor intrusion assessment. Vulnerability to soil gas entry can be assessed for a specific building by using any of several methods, including:

- Concurrently monitoring indoor air samples for presence of radon and finding radon in indoor air at levels greater than in ambient air.<sup>125</sup>
- Concurrently monitoring indoor air and ambient air (see Section 6.3.5) and finding cis-1,2-dichloroethylene, vinyl chloride, 1,1-dichloroethylene, or 1,1-dichloroethane in indoor air at levels greater than in ambient air, when and where they are present in the subsurface vapor source(s), but are not used indoors.<sup>126</sup>
- Employing a photoionization detector (PID) or other real-time in-field device, capable of detecting parts per billion by volume (ppbv) levels, to directly survey suspected locations of soil gas entry (e.g., utility penetrations, sumps) and finding elevated readings of vapors.
- Conducting a visual inspection for cracks and holes in concrete foundation slabs, basement walls, or any floor drain(s). (Openings for soil gas entry will not necessarily be visible or accessible for inspection, so the absence of visible openings, by itself, is insufficient to demonstrate that a building is not susceptible to soil gas entry.)
- Monitoring pressure differences between the building and subsurface environment to characterize the ‘driving force’ for soil gas entry and the effects of the heating, ventilation, and air-conditioning (HVAC) systems.
- Injecting tracers into the subsurface at selected concentrations and subsequently finding it in indoor air samples.

Certain complementary information obtained for the building, as identified in Section 6.4.1, can also support such assessments. Relevant information includes the operating characteristics of HVAC systems.

In many commercial buildings, the HVAC system brings outdoor air into the building, potentially creating building over-pressurization relative to the outdoor environment. When the building is

---

<sup>125</sup> Because vapor intrusion and radon intrusion entail similar mechanisms for subsurface vapor migration and gas entry into buildings and structures (Section 2.3), naturally occurring radon may serve as a tracer to help identify those buildings that are more susceptible to soil gas entry than others. Buildings with radon concentrations greater than levels in ambient air are likely susceptible to soil gas intrusion and would likely be susceptible to intrusion of any chemical vapors in the subsurface. On the other hand, the radon concentration in a building is not generally expected to be a good quantitative indicator of indoor air exposure concentrations of vapor-forming chemicals arising from subsurface contamination. Hence, radon measurement is not generally recommended as a proxy for directly measuring vapor-forming chemicals in indoor air. Among other factors, the distribution of radon-emanating rock and soil and the spatial and temporal variability of their source strength are generally expected to be very different (e.g., tending to be broader and more uniform) than the distribution and source strength variability for subsurface sources of chemical vapors.

<sup>126</sup> EPA (2011a) reports that “vinyl chloride, 1,1-dichloroethylene, cis-1,2-dichloroethylene, and 1,1-dichloroethane are rarely detected in background indoor air.” DoN (2011a) also reports that vinyl chloride and cis-1,2-dichloroethylene “are rarely detected in background indoor air.” When they are subsurface contaminants, volatile chemicals that are rarely or never present in indoor sources can be inferred to arise in indoor air via vapor intrusion “without further explanation” (DoN 2011a). Brenner (2010), for example, employed this principle (and cis-1,2-dichloroethylene) to identify buildings susceptible to vapor intrusion and to diagnose the relative contributions of vapor intrusion and infiltration to indoor air concentrations.

over-pressurized sufficiently to eliminate the driving force for soil gas entry over at least a portion of the building foundation, vapor intrusion potential is diminished.<sup>127</sup>

Reasonably expected future risks posed by subsurface contamination warrant consideration, in addition to risks posed under current conditions, “in order to demonstrate that a site does not present an unacceptable risk to human health and the environment” (EPA 1991a). For example, current building use and HVAC systems might not be sustained perpetually. Therefore, when the subsurface vapor source(s) underneath or near a building with an over-pressurizing HVAC system has(have) significant potential to pose a vapor intrusion threat, it may be useful to assess susceptibility to soil gas entry and diagnose vapor intrusion (also see Sections 6.3.4 and 6.4.1) in such buildings under conditions when the HVAC system is not operating. (In addition, indoor air testing could be conducted during periods when the HVAC system operates with diminished flows, such as weekends or evenings.) The results of such testing can be used to support determinations about whether the vapor intrusion pathway is “potentially complete” and is reasonably expected to pose unacceptable human health risk (see Section 7.4) in the future,<sup>128</sup> in which case a response action(s) may be warranted (see Section 7.7). For example, if the results indicate susceptibility to soil gas entry when the HVAC system is not in operation and vapor intrusion under these conditions has the potential to pose a health concern, then the building may warrant future monitoring (e.g., continuous monitoring of the pressure gradient across the foundation or indoor air testing) and/or engineered exposure controls, which may be enforceable through an institutional control (IC) (see Section 8.6).

Likewise, well-designed and operated radon mitigation systems generally should diminish vapor intrusion via soil gas entry under current conditions. Therefore, buildings with pre-existing radon mitigation systems, which overlie or are near subsurface vapor sources, could be tested under conditions where the radon mitigation system is temporarily not operated to support decisions about monitoring and ICs as part of a vapor intrusion remedy.<sup>129</sup>

#### 6.3.4 Evaluate Presence and Concentration of Subsurface Contaminants in Indoor Air

Indoor air sampling (see Section 6.4.1) using time-integrated sampling methods or grab samples can confirm the presence, if any, of a site-related vapor-forming chemical (i.e., one comprising the subsurface vapor source(s)) in the indoor environment. When combined with data characterizing subsurface vapor migration and demonstrating the building is (or is not) susceptible to soil gas entry, indoor air sampling data can support determinations that the vapor intrusion pathway is (or is not) complete for a given building, as discussed further in Section 7.3. When conducted contemporaneously in multiple buildings, indoor air sampling can, in concert with soil gas survey data and data delineating subsurface vapor sources, help identify the boundaries of the land area(s) within which buildings are known or suspected to have indoor air concentrations of subsurface contaminants arising from vapor intrusion (also see Section 6.2.1).

---

<sup>127</sup> Over-pressurization may not be uniform throughout a building, particularly in large buildings. Over-pressurization in portions of a building will not necessarily mitigate all openings for soil gas entry.

<sup>128</sup> “Both current and reasonably likely future risks need to be considered in order to demonstrate that a site does not present an unacceptable risk to human health and the environment.” (EPA 1991a).

<sup>129</sup> EPA recommends that state and local laws be researched before any such testing is conducted. Some areas have local ordinances governing operation and maintenance of radon mitigation systems.

Indoor air sampling is most commonly conducted using time-integrated sampling methods, when characterizing exposure concentrations for building occupants (see Section 6.4.1), which may include contributions from “indoor” or ambient air sources of these chemicals (see Section 2.7). For example, time-integrated concentrations of hazardous vapors in samples of indoor air can be compared to appropriate, risk-based screening criteria (see Section 6.5) to obtain some preliminary insights about the potential level of exposure and risk posed by vapor intrusion or can be used to support a human health risk assessment (Section 7.4) about vapor-forming chemicals found in the subsurface environment.<sup>130</sup>

When sampling indoor air (or sub-slab soil gas) to characterize exposure concentrations arising from vapor intrusion, EPA recommends removing potential indoor sources of vapor-forming chemicals (see Section 2.7 and 6.4.1) from the building to strive to ensure that the concentrations measured in the indoor air samples are attributable to the vapor intrusion pathway. However, even after removing indoor sources, their effects may linger depending on source strength, relative humidity in the building, the extent to which the contaminants have been absorbed by carpets and other fabrics or “sinks,” and air exchange rate. In addition, field experience suggests that it may not be possible to remove all indoor sources. It may be particularly impractical to do so in industrial settings where vapor-forming materials are used or stored.

### 6.3.5 Identify and Evaluate Contributions from Indoor and Ambient Air Sources

As noted in Section 2.7 herein, indoor air is likely to contain detectable levels of a number of vapor-forming chemicals regardless of whether the building overlies a subsurface vapor source, because indoor air can be impacted by a variety of indoor and outdoor vapor sources unrelated to site contamination. The contribution of indoor and outdoor vapor sources (or both) to indoor air concentrations is referred to as “background” throughout this Technical Guide, when they do not arise from site-related contamination (see Glossary). Information on ‘background’ contributions of site-related, vapor-forming chemicals in indoor air is important to risk managers because generally EPA does not clean up to concentrations below natural or anthropogenic background levels (EPA 2002e).

To determine if a subsurface vapor source(s) is (or are) responsible for indoor air contamination, EPA recommends that such background sources of site-specific analytes be identified and distinguished from vapor-forming chemicals arising from vapor intrusion. A comprehensive investigation of all background substances found in the environment is usually not recommended. For example, sub-slab soil gas and ambient air samples typically would not be analyzed for radon for purposes of characterizing ‘background’ exposures *per se*, whereas EPA would recommend analyzing for radon if its precursor was part of a regulated release to the subsurface environment (EPA 2002e).<sup>131</sup> Generally, EPA recommends the site planning and

---

<sup>130</sup> In certain cases, depending in part on the results (e.g., concentrations exceed risk-based screening levels), indoor air sampling data may be a sufficient basis for supporting decisions to undertake pre-emptive mitigation/early action (see Sections 3.3 and 7.8) in lieu of additional rounds of sampling and analysis or an evaluation of the contribution of background sources to indoor air concentrations.

<sup>131</sup> Sub-slab soil gas and indoor air samples might also be analyzed for radon, where its precursor was not part of a release to the subsurface environment, for purposes of diagnosing vulnerability to soil gas entry (see, for example, Section 6.3.3), depending upon the objectives of the vapor intrusion investigation.

data evaluation team limit chemical analyses to those vapor-forming chemicals known (based upon subsurface contaminant characterization) or reasonably expected (based upon site history) to be present as a result of a release to the subsurface environment.

To support evaluations of sources of indoor air concentrations, EPA recommends conducting a building survey (see Section 6.4.1) that identifies in individual buildings known or suspected indoor sources of the vapor-forming chemicals also found in the subsurface (see Section 2.7) and characterizing ambient air quality (see Section 6.4.2) in the site vicinity for these same chemicals. Key supporting information includes: (1) the locations and types of known or potential indoor vapor sources; (2) information about outdoor vapor sources related to the site (e.g., locations of chemical storage, use, and/or release to the environment); (3) information about outdoor vapor sources un-related to the site, such as nearby commercial or industrial facilities and mobile sources (e.g., cars, trucks, and other equipment); and (4) data on the local ambient air quality.

Interviews of building occupants and inspections of buildings can be helpful initial sources of information about indoor uses and storage of vapor-forming consumer and commercial products.<sup>132</sup> In addition, vapor-detecting field instruments and in-field gas chromatographs<sup>133</sup> can be used to locate indoor vapor sources. Grab (essentially short-duration) samples of indoor air, as described in Section 6.4.1, can be useful for identifying specific vapor-forming chemicals emanating from indoor vapor sources of consumer or commercial products. When the objective is to quantitatively distinguish contributions to indoor air concentrations from vapor intrusion versus contributions from indoor and ambient air sources, as described below, EPA recommends obtaining indoor air concentrations using time-integrated sampling methods (see Section 6.4.1) instead of grab samples.

If the subsurface vapor source(s) is (or are) comprised of multiple vapor-forming chemicals and the subsurface source medium (e.g., soil, groundwater) and location are identical for these chemicals, then contemporaneous samples of sub-slab soil gas (see Section 6.4.3) and indoor air (see Section 6.4.1) can be compared, potentially supporting one of the following conclusions:

Results indicating vapor intrusion as solely responsible for vapor concentrations in indoor air. The predominant vapor-forming chemicals in the sub-slab soil gas and their relative proportions in indoor air and sub-slab vapor samples would be expected to be similar, whereas their concentrations in sub-slab soil gas would be expected to be substantially higher than in indoor air,<sup>134</sup> if vapor intrusion is solely responsible for indoor air

---

<sup>132</sup> Information about the chemical composition of commonly encountered products is provided by the U.S. Navy (DoN 2011a, Appendix A) in its guidance for background analysis for the vapor intrusion pathway.

<sup>133</sup> Gorder and Dettenmaier (2011) reported on the use of a field-portable gas chromatograph and mass spectrometer to identify specific sources of vapor-forming chemicals and estimate their mass emission rate(s). EPA's Environmental Response Team has employed the Trace Atmospheric Gas Analyzer (TAGA) mobile laboratory for similar purposes.

<sup>134</sup> Based upon the generic sub-slab attenuation factor identified in Section 6.5.3 herein, sub-slab soil gas concentrations can be expected to typically exceed indoor air concentrations by 33 times or more in residences that are impacted by vapor intrusion (i.e., 33 is the inverse of an attenuation factor of 0.03), when background sources are negligible and the building is under-pressurized relative to the subsurface during indoor air sampling.



concentrations.<sup>135</sup> If recalcitrant (i.e., not subject to biodegradation in the vadose zone), the predominant vapor-forming chemicals and their relative proportions in the subsurface vapor source would likewise tend to be similar to those in indoor air if vapor intrusion is solely responsible for indoor air concentrations.<sup>136</sup>

Results indicating indoor vapor sources as primarily responsible for indoor air concentrations. If a vapor-forming chemical is present with an elevated concentration in indoor air, but is not present or is negligibly present in sub-slab soil gas samples (or representative samples of the subsurface vapor source), then the presence of this contaminant in indoor air may not arise from the vapor intrusion pathway, but rather from indoor sources or other background sources (e.g., ambient air). In these circumstances, EPA recommends considering additional attempts to identify and temporarily eliminate indoor sources, where practical, and re-sample indoor air and sub-slab soil gas after doing so.

Likewise, outdoor (ambient) air samples can be collected (see Section 6.4.2) contemporaneously with indoor air (see Section 6.4.1) and sub-slab soil gas (see Section 6.4.3) samples, as recommended in Section 6.4.

Results indicating outdoor vapor sources as primarily responsible for indoor air concentrations. If a vapor-forming chemical(s) is(are) detected in outdoor air and indoor air at similar concentrations, but is(are) not present in sub-slab soil gas samples (or representative samples of the subsurface vapor source) or is present in the subsurface samples at concentration(s) similar to indoor air,<sup>137</sup> then the presence of this contaminant(s) in indoor air may not arise from the vapor intrusion pathway, but rather from outdoor sources (i.e., ambient air).

Concentrations of vapor-forming chemicals in indoor air, sub-slab soil gas, and ambient air can be compared, as described above, using an individual time-integrated sample for each medium. Recognizing that weather conditions and building operations can lead to variable contributions from vapor intrusion and ambient air infiltration over time, EPA recommends, however, that such

---

<sup>135</sup> Conversely, if there is an interior source of a vapor-forming chemical in indoor air samples, the relative proportion of this chemical in indoor air will be greater than its respective proportion in the sub-slab soil gas, even where vapor intrusion is occurring, assuming that the other vapor-forming chemicals in the sub-slab soil gas do not have 'background' sources.

<sup>136</sup> Conversely, if there is an interior source of a vapor-forming chemical in indoor air samples, the relative proportion of this chemical in indoor air will be greater than its respective proportion in the subsurface vapor source or in "near-source" soil gas samples (see Section 6.3.1), even where vapor intrusion is occurring, assuming that the other vapor-forming chemicals in the sub-surface do not have 'background' sources.

<sup>137</sup> Sample concentrations of vapor-forming chemicals in indoor air and sub-slab soil gas can be compared to conservative, risk-based screening levels to provide a complementary line of evidence. Generally, vapor-forming chemicals with concentrations that consistently fall below screening levels (see Section 6.5) through multiple sampling events (see Section 6.4) warrant no further action or study, so long as the exposure assumptions match those taken into account by the calculations and the site fulfills the conditions and assumptions of the generic conceptual model underlying the screening levels (see Section 6.5.2).

comparisons be made for multiple sets of paired samples, collected in different seasons,<sup>138</sup> to support any conclusion that vapor intrusion is not a significant contributor to indoor air concentrations, which can instead be attributed to indoor and outdoor sources unrelated to the subject site. Even with a few sets of such samples, rigorous statistical tests may not be feasible. Nevertheless, comparing contemporaneously measured concentrations and proportions of vapor-forming chemicals in indoor air, subsurface media, and ambient air can be effective for this investigation objective, particularly when one (or more) of the analytes is known to be present only in the subsurface or in ambient air.

The following hypothetical example illustrates how site-specific sampling data might inform conclusions about the relative contributions of indoor versus subsurface vapor sources in a building overlying contaminated groundwater:

*Example: Time-integrated samples of indoor air, outdoor air, and subslab soil gas were collected contemporaneously for a building that overlies shallow groundwater that is contaminated with a suite of vapor-forming chemicals (designated as VFCA, VFCE, VFCC, and VFCD). The sampling results are summarized as follows:*

Vapor-forming Chemical in Groundwater	Time-weighted Sample Concentrations ( $\mu\text{g}/\text{m}^3$ )			Ratio of Subslab Concentration to Indoor Air Concentration
	Subslab Soil Gas	Indoor Air	Outdoor Air	
VFCA	1	0.65	0.75	3
VFCE	33,000	26	0.18	1,300
VFCC	5,200	5.8	0.14	900
VFCD	15,000	15	0.51	1,000

*Based upon the conceptual site model, the presence of these vapor-forming chemicals in outdoor (ambient) air is believed to be due to anthropogenic sources that are not associated with the environmental release responsible for the subsurface contamination. The building is presumed to be susceptible to vapor intrusion, as indicated by pressure monitoring data that indicate building under-pressurization, relative to the subsurface environment, during the sampling event (as discussed further in Section 6.4.1).*

*Based upon these findings, the presence of VFCE, VFCC, and VFCD in indoor air appears to be solely or primarily attributable to vapor intrusion. The relative proportions*

<sup>138</sup> A goal of collecting multiple samples is to observe and characterize a reasonable maximum vapor intrusion condition for the respective building. Because weather conditions and building operations can lead to time-variable contributions from vapor intrusion (e.g., driving forces for vapor intrusion; see Section 2.3) and ambient air infiltration (see Sections 2.4), indoor air concentrations of vapor-forming chemicals can be expected to vary over time. An individual sample, collected at a randomly chosen time, may under-estimate or over-estimate average and reasonable maximum exposure conditions (see Section 6.4.1) to different degrees, depending upon the season of sample collection and other factors.

*of these subsurface contaminants in indoor air and sub-slab vapor samples are similar, as indicated by a similar ratio of subslab to indoor air concentration, considering analytical uncertainty. In addition, their indoor air concentrations exceed those found in the paired sample of ambient air.*

*By contrast, the presence of VFCA in indoor air may be entirely attributable to infiltration of ambient air, as the sample concentrations in indoor air and outdoor are similar, considering analytical uncertainty.*

*Recommended next steps in the investigation might include a human health risk assessment (see Section 7.4) and a review of the conceptual site model (see Section 5.4) to evaluate whether the different conclusion for VFCA can be reasonably explained (e.g., by vapor attenuation in the vadose zone that is expected to be substantially greater than for VFCA, VFCC, and VFCD).*

EPA has compiled and published an evaluation of studies pertaining to indoor air concentrations of volatile organic compounds in North American residences in 1990-2005 (EPA 2011a), which can be employed to identify whether measured indoor air concentrations in residences exceed the historical range of background concentrations. Specifically, if measured indoor air concentrations are found to greatly exceed the historical range of background levels, there is a greater likelihood that the indoor air concentrations are the result of vapor intrusion. This conclusion is supported by the expectation that current levels of vapor-forming chemicals in ambient air and in indoor air due to indoor and ambient air sources are likely to be lower than those observed historically,<sup>139</sup> due to regulations and business practices fostering less use of toxic chemicals in consumer products and industrial processes and reduced emissions from mobile and stationary sources. As a result of this expectation, EPA does not recommend the use of generic values of historical background concentrations, even those cited in peer-reviewed publications or available from databases maintained by regulatory agencies, to characterize current levels in any building, for purposes of supporting conclusions that indoor air concentrations are due to 'background' sources. Rather, EPA recommends that site-specific data (e.g., sub-slab, indoor air and ambient air sampling data) be obtained (as described in Sections 6.4.1, 6.4.2, and 6.4.3), and evaluated, as described above, when the investigation objectives include determining whether indoor air concentrations arise from indoor or ambient air sources.

The following additional approaches for identifying and characterizing 'background' sources may warrant consideration in special situations:

- McHugh et al. (2012) have demonstrated the principle that building over-pressurization can be employed temporarily to minimize vapor intrusion and facilitate measuring indoor

---

<sup>139</sup> McCarthy et al. (2007), for example, analyzed ambient air data for 25 toxic substances collected in the United States from 1990 through 2005 and found that concentrations of many halogenated volatile organic compounds were declining at most sites and evaluation periods (i.e., 1990-2005, 1995-2005, and 2000-2005). They found that concentrations of petroleum hydrocarbons, such as benzene, associated with mobile sources were all consistently decreasing over the three evaluation periods at most sites.

air concentrations under conditions where only indoor sources may be contributing.<sup>140</sup> At this time, however, there are no standard practices for using over-pressurization to assess ‘background’ contributions, which is a research and development need (SERDP-ESTCP 2014).

- Forensic and multi-variate statistical methods have been described and illustrated by the U.S. Navy (DoN 2011a) in its guidance for background analysis for the vapor intrusion pathway.

### 6.3.6 Select, Prioritize, and Sequence Investigation Objectives

Site-specific investigations of potential vapor intrusion frequently begin with pursuing one or more of the objectives presented in Sections 6.3.1 through 6.3.5. Criteria potentially warranting consideration by the site planning team when making decisions about prioritizing and sequencing investigation objectives include, but are not limited to: site scenario (see Section 6.1); building occupants who may be particularly sensitive to the potentially toxic effects of vapors; buildings that are more susceptible to soil gas entry (e.g., buildings with deteriorating basements or dirt floors); whether there are any significant data gaps in the CSM (see Section 5.4); and relationships with and perspectives of the owners and occupants of potentially impacted buildings.

Characterizing subsurface vapor sources (Section 6.3.1), characterizing subsurface vapor migration (Section 6.3.2), and evaluating the presence of subsurface contaminants in indoor air (Section 6.3.4) – are frequently candidates for an initial objective and each can be pursued separately. For example, characterizing subsurface vapor sources (Section 6.3.1) may be a useful initial choice when responding to an initial report about a release of hazardous, vapor-forming chemicals to the subsurface from a commercial or industrial operation or when buildings do not exist currently, but are expected in the future. Characterizing subsurface vapor sources may also be a useful initial choice when building owners or occupants are reluctant to grant access for indoor air testing. In this situation, the site planning team may need to pursue subsurface investigations more intensely to characterize vapor intrusion potential before being granted building access. On the other hand, testing indoor air is recommended as an initial objective when responding to reports of odors in buildings or clusters of inhalation-related symptoms and there is credible information to suggest that a subsurface environmental release may be a contributing factor (see Section 5.2).

In a different scenario, characterizing subsurface vapor migration (Section 6.3.2) may be a useful starting point when addressing sources that are comprised of potentially biodegradable chemicals or that are suspected to occur below an extensive geologic layer that might impede upward diffusive migration. For large buildings with HVAC systems that may over-pressurize the interior relative to the subsurface environment, EPA generally recommends: a building assessment early in the investigation, which obtains and weighs the complementary information

---

<sup>140</sup> Indoor air concentrations measured after sufficient periods of over-pressurization may be indicative of ‘background’ levels, whereas indoor air concentrations detected before and after a sufficient period of “rebound” from temporary over-pressurization may be indicative of joint contributions from ‘background’ sources and any vapor intrusion from the subsurface.

identified in Section 6.4.1, to support investigation planning; and an evaluation of susceptibility to soil gas entry under conditions when the HVAC system is not operating (see Section 6.3.3).

Each of the investigation objectives described in Sections 6.3.1 through 6.3.5 may, in some cases, be conducted iteratively with increasing complexity as the investigation proceeds and the CSM is refined. For example, field instruments can be useful for locating potential background sources (e.g., household or commercial cleaning products) (see Section 6.3.5) and grab (essentially short-duration) samples of indoor air, as described in Section 6.4.1, can be useful for characterizing the chemical composition of identified indoor sources of vapors during an initial building reconnaissance while potential background sources are surveyed. These activities might be followed by indoor air and sub-slab soil gas sampling, using time-integrated sampling methods as described in Section 6.4.1 and 6.4.2, to distinguish subsurface contributions from indoor sources. More advanced methods of distinguishing the various potential contributions to indoor air might be utilized, if warranted, in intermediate phases of the investigation under such an iterative approach.

#### 6.4 General Principles and Recommendations for Sampling

Sampling of indoor air, outdoor air, soil gas, and groundwater and analysis for vapor-forming chemicals can play an important role in vapor intrusion investigations for one or more of the objectives identified in Section 6.3. This subsection summarizes for indoor air, outdoor air, sub-slab soil gas, exterior soil gas, and groundwater the following:

- Principal methods for collecting samples.
- Potential uses of the resulting sampling data.
- Recommended practices for sample collection.
- Unique or frequently encountered logistical issues.

We would note that soil and NAPL sampling has been and may be used to characterize the nature (e.g., chemical composition) and general location of subsurface vapor sources (see Section 6.3.1). Information about soil sampling can be found in *Standard Operating Procedures, Soil Sampling* (EPA-ERT 2001b). However, bulk soil (as opposed to soil gas) sampling and analysis is not currently recommended for estimating the potential for vapor intrusion to pose unacceptable human health risk in indoor air, because of the potential for vapor loss due to volatilization during soil sampling, preservation, and chemical analysis. In addition, there are uncertainties associated with soil partitioning calculations.

To ensure that the sampling data will meet the site-specific data quality needs, EPA recommends that the sampling and analytical methods selected by the site planning team be capable of obtaining reliable analytical detections of concentrations less than project-appropriate, risk-based screening levels (e.g., VISLs). Towards that end, EPA recommends that, as part of establishing site-specific data quality objectives (DQOs), the planning and data collection team(s) consult with a laboratory skilled in the analysis of air and soil gas samples and choose sampling and analytical methods capable of routinely attaining the desired detection sensitivity for each medium.

EPA also recommends that the site planning team identify and utilize appropriate sampling locations and durations and address spatial and temporal variability to fulfill the specific objectives of the investigation, which may include obtaining data to characterize the potential human exposure in a building(s). EPA recommends the CSM, the objective(s) of the investigation, and other site-specific information be considered in determining the number and types of samples used at a specific site.

The sampling duration depends on the type of medium being sampled (for example, soil gas, sub-slab soil gas, and indoor or outdoor air) and analytical methods (for example, Method TO-15). Some of the key recommended considerations are provided in the following subsections. Several rounds of sampling are recommended to develop an understanding of temporal variability<sup>141</sup> to ensure that final risk management decisions are based upon a consideration of a reasonable maximum vapor intrusion condition.<sup>142</sup>

#### 6.4.1 Indoor Air Sampling

Indoor air sampling results are used to assess the presence of and level of human health risk posed by vapor-forming chemicals in indoor air (see Sections 6.3.4 and 7.4), and to diagnose whether vapor intrusion is occurring (see Sections 6.3.3, 6.3.5, and 7.3). These two uses of indoor air sampling in vapor intrusion investigations are discussed further below with recommended methods for each. As discussed further in Sections 8.4 and 8.7, indoor air sampling may also be useful for supporting performance evaluations of vapor intrusion mitigation systems and verifying the health protectiveness of subsurface remediation systems.

EPA recommends that the decision to collect indoor air data be supported by lines of site- or building-specific evidence (e.g., characterization of subsurface vapor source(s) strength and proximity to building(s), vadose zone conditions, and building conditions) that demonstrate that vapor intrusion has the potential to pose a significant human exposure. Confidence in the assessment is expected to be higher when multiple lines of site- or building-specific evidence, in addition to indoor air data, come together to provide mutually supporting evidence for a common understanding of the site conditions/scenarios and the potential for vapor intrusion (i.e., the various lines of evidence are in agreement with each other).

A potential shortcoming of indoor air testing is that indoor sources and outdoor sources unrelated to subsurface contamination and to releases from the subject site – “background” (see Glossary) – may contribute to the presence of volatile chemicals in occupied buildings (see Section 2.7), particularly if these sources cannot be removed from the building prior to and throughout the duration of sampling indoors. This shortcoming of indoor air testing is

---

<sup>141</sup> Seasonally variable conditions (e.g., moisture levels, depth to groundwater) can lead to seasonally variable concentrations and distributions of vapors in the vadose zone. Likewise, weather conditions and building operations can lead to time-variable contributions from vapor intrusion (e.g., driving forces for vapor intrusion; see Section 2.3) and ambient air infiltration (see Sections 2.4). Collectively, these processes cause indoor air concentrations of vapor-forming chemicals to vary over time (see Section 2.6). An individual sample (or single round of sampling) would be insufficient to characterize seasonal variability, or variability at any other time scale.

<sup>142</sup> EPA recommends basing the decision about whether to undertake response action for vapor intrusion (i.e., a component of risk management; see Section 7.4) on a consideration of a reasonable maximum exposure (e.g., EPA 1989, 1991a), which is intended to be a semi-quantitative phrase, referring to the lower portion of the high end of the exposure distribution (see Glossary).

unavoidable when the subsurface environment contains the very same volatile chemicals that contemporaneously arise in indoor air due to background sources, which is common for some chemicals and relatively rare for others (EPA 2011a). In this circumstance, additional lines of evidence, possibly including special procedures and analyses, may warrant evaluation to distinguish background contributions from those originating from vapor intrusion (see Section 6.3.5).

After discussing recommended sampling methods and practices for the primary uses of indoor air sampling data, this sub-section concludes by discussing:

- Recommended measures to reduce the impact of indoor sources of vapor-forming chemicals.
- Recommended approach to establishing analyte lists for indoor air samples.
- Complementary, building-specific data (i.e., additional lines of evidence) that can be collected contemporaneously while indoors.

Characterize Human Exposure Levels. Indoor air sampling and analysis provide a direct approach to obtaining concentrations of vapor-forming chemicals in indoor air to which building occupants can be exposed. For this purpose, EPA generally recommends time-integrated sampling methods, since indoor air concentrations can be temporally variable<sup>143</sup> and time-integrated exposure estimates over appropriate exposure durations (e.g., chronic typically; less-than-chronic in some cases) are generally most useful for assessing human exposure and human health risk (see Section 7.4).

Because of variability, a single indoor air sample, collected at a randomly chosen time, is insufficient information to estimate an average exposure. On the other hand, it is impractical to collect indoor air samples continuously over a chronic exposure period (i.e., up to 30 years for a reasonable maximum exposure duration in a residence (EPA 2014a)), which would also entail deferring risk management decisions for a prolonged period while human exposures from vapor intrusion could occur unabated. Hence, current and past practice has generally relied upon collecting multiple indoor air samples for purposes of estimating long-term average (i.e., chronic) exposures and assessing human health risk (see Section 7.4). All else being equal, a longer collection period for each individual sample would be expected to yield a more reliable basis for estimating long-term, time-average exposure than would a one-day sample collection period.

When investigating short-term exposure conditions that might warrant prompt response action to protect human health (see, for example, Sections 5.2 and 7.5.2), time-integrated indoor air samples can provide useful estimates of exposure for the location and time period of sample collection. (A short-term exposure is defined as a “repeated exposure for more than 24 hours,

---

<sup>143</sup> Because weather conditions and building operations can lead to time-variable contributions from vapor intrusion (e.g., driving forces for vapor intrusion; see Section 2.3) and ambient air infiltration (see Sections 2.4), indoor air concentrations of vapor-forming chemicals can be expected to vary over time (see Section 2.6). Field observations indicate that indoor air concentrations arising from vapor intrusion can be temporally variable within a day and between days and seasons in an individual residential building (EPA 2012f; Holton et al., 2013ab).

up to 30 days” – see Glossary.) All else being equal, a longer collection period for an individual sample would be expected to yield a more reliable basis for estimating time-average short-term exposure than a one-day sample.

As noted above, EPA also recommends considering potential health effects and relevant exposure periods for site-related, vapor-forming chemicals when developing DQOs and sampling plans for indoor air.

Variability in laboratory analyses can be considered when evaluating these data in support of risk management decisions.<sup>144</sup>

Time-integrated samples provide a direct measurement of the average chemical concentration over a fixed period of time (e.g., ranging from 8 hours to several weeks, depending upon the sampling method, its capabilities, and its deployment). Time-integrated samples can be collected using either evacuated canisters, which collect gas in a container, or sorbent samplers, which collect vapor-forming chemicals on a sorbent material.

#### *Evacuated canisters*

Evacuated canisters are spherical- or cylindrical-shaped stainless steel or silica-lined containers that are prepared to be under negative pressure relative to the environment and certified by the laboratory to be clean and leak-free.<sup>145</sup> As described in EPA Method TO-14A (EPA 1999c), evacuated canisters can be used as passive (sub-atmospheric pressure sampling) or active (pressurized sampling) samplers. In both cases, the canister is initially evacuated to a standard vacuum in preparation for sampling. For sub-atmospheric sampling, when the canister is opened for sample collection, the differential pressure causes air to flow into the canister without use of a pump. In this case, sampling must end before the vacuum is fully dissipated, else the sample collection period will be unknown. For pressurized sampling, a pump is used to pass air into the canister until a specified pressure (up to two atmospheres) is reached. In both cases, a flow-control device is used to maintain a constant flow into the canister over the desired sample period. To ensure that the canisters are filling at the proper rate, EPA recommends checking the flow rate periodically during sample collection. EPA Methods TO-14A and TO-15 provide further information on measuring and controlling flow rates into canister-type samplers.

---

<sup>144</sup> For a recently published study, EPA's ORD determined "The acceptance criterion to demonstrate equivalency is  $\pm 30\%$  ... based on what is defined as acceptable reproducibility in vapor intrusion field studies" (EPA 2012f).

<sup>145</sup> Canisters are cleaned and re-used because they are too expensive to dispose routinely. The certification process entails cleaning the interior of the container using a combination of dilution, heat, and high vacuum. Canisters are then analyzed for a large suite of vapor-forming chemicals to establish that they are free of detectable chemicals at a suitably low (sensitive) detection level. The cleanliness of canisters can be certified individually (i.e., direct testing of each canister, or 100% certification), which is generally desirable in instances where the data are to be used for exposure/risk assessment purposes. Alternatively, canisters can be certified by batch (or lot), in which a subset of the canisters are tested directly (e.g., 10%) and results are extrapolated to the remainder of the batch. Batch-certified canisters may be sufficient when concentrations of target analytes are expected to be high, relative to potential levels of residual contamination in the canister after cleaning. EPA recommends that flow controllers also be cleaned between uses to avoid artificial contamination.



Typically, for vapor intrusion investigations, indoor air samples are collected using six-liter canisters using sub-atmospheric pressure sampling over a 24-hour period in residences or over an 8-hour period (or workday equivalent) in commercial and industrial settings, when using these devices. Larger canisters (i.e., 15-liter) allow higher flow rates and may be preferable for longer sampling events or to collect a larger volume of sample.<sup>146</sup> A capillary flow controller has been developed and demonstrated for use in industrial hygiene applications (Rossner et al. 2002; Rossner and Wick 2005), which may hold promise for extending sampling time periods for indoor air with standard-sized canisters.

Details for selecting and utilizing sampling canisters are provided in EPA Methods TO-14A (EPA 1999c) and TO-15 (EPA 1999d). EPA's Environmental Response Team has developed a standard operating procedure for sampling air with evacuated canisters (EPA-ERT 1995).

An advantage of using evacuated canisters for sample collection is the capability of analyzing multiple sub-samples from the same canister (because these canisters obtain a "whole air" sample). They are also reasonably easy to deploy and retrieve. However, sample recovery and representativeness can be affected by ambient conditions; for example, low humidity conditions in the sample may lead to losses of certain volatile compounds on the canister walls (EPA 1999c).

Fourteen days is the most commonly cited hold time for air samples in canisters. Some analytes, however, may be stable in canisters for up to 30 days.

### *Sorbent Samplers*

Sorbent sampling devices are hollow containers that hold one or more adsorbent media that can bind vapor-forming chemicals. They have been developed and tested over several decades for industrial hygiene monitoring and have more recently been employed for other purposes, including vapor intrusion investigations. Sorbent samplers can be used in an active or passive mode.

In the active mode, a pump is used to draw air at a known rate through the device. The flow rate and sampling volume are determined based on the type of sorbent used, the target constituent(s), and the amount of sorbent contained in the device. Care must be taken to ensure that the volume of air drawn through the tube does not exceed the "breakthrough" volume<sup>147</sup> (i.e., the volume of air which may be passed through the sorbent tube before a detectable level of the analyte concentration elutes from the non-sampling end), else the time-weighted average concentration will be biased low by an unknown amount.

In the passive mode, no pump is used, and vapor-forming chemicals enter the device due to diffusion. Consequently, passive (diffusion) samplers may be placed in locations of interest without consideration of power availability.

---

<sup>146</sup> Alternatively, two (or more) large canisters can be connected together to allow collection of time-integrated samples over longer durations, which is generally desirable for characterizing long-term average exposure levels.

<sup>147</sup> For this reason, sample volumes in the one- to four-liter range are generally recommended for this method (EPA 1999e).

Although passive (diffusion) samplers have been less commonly used to quantify indoor air concentrations, their use may grow as a result of recent demonstrations that they can yield results comparable to those obtained using evacuated canisters (EPA-Region 9 2010; EPA 2012f; Odencrantz et al. 2009; Odencrantz et al. 2008),<sup>148</sup> and a recognition that they may be less intrusive for some building owners and occupants and more convenient for field staff (EPA-Region 9 2010). Passive samplers are also capable of being deployed for longer durations than evacuated canisters, thereby providing a more economic means of obtaining average indoor air concentrations over longer periods of exposure. Time-integrated samples of indoor air over longer periods than one day are also indicated by field observations demonstrating that indoor air concentrations arising from vapor intrusion can be temporally variable within a day and between days and seasons (EPA 2012f; Holton et al., 2013a).

The basic configuration of a passive sampler is a solid, typically granular, sorbent contained in a metal, glass or plastic container with openings of known dimensions. Several different containers and a wide range of adsorptive media are commercially available, which function similarly. After sample collection, adsorbed mass is measured in a laboratory for each analyte; the two most common analytical methods involve thermal desorption or solvent extraction combined with gas chromatography/mass spectrometry. The air concentration for each analyte is calculated from the adsorbed mass, the duration of sampling, and the uptake rate.

The uptake rate is dependent upon the geometry of the sampling device and the diffusion coefficient of the analyte. The uptake rate is the most critical variable for accurately measuring air concentrations with passive samplers, since the sampling duration and adsorbed mass can generally be measured very accurately. Fortunately, most commercially available passive samplers have published uptake rates for several compounds, which collectively address many of the vapor-forming chemicals described in Section 3.1.<sup>149</sup> Once the target analyte(s) and uptake rate(s) are known, the sample duration needed to attain data quality objectives (i.e., reporting limit equal to or lower than the risk-based screening level or risk-based action level) can be calculated for each analyte.

Uptake rates of deployed samplers can be affected by ambient conditions (e.g., temperature, because chemical-specific diffusion rates are temperature-dependent; and humidity, which influences the uptake of water vapor, which may interfere with retention and stability of the analyte and/or with laboratory analysis). EPA, therefore, recommends that ambient conditions be recorded during deployment of passive samplers.

One potential advantage of passive samplers is that they can be left unattended for relatively longer durations, thereby conveniently providing estimates of longer-term time-

---

<sup>148</sup> For example, EPA's National Exposure Research Laboratory found that Radiello™ charcoal passive samplers performed well for sampling periods up to 28 days for TCE (EPA 2012f). In that study, one-week (7-day) Radiello™ passive samplers were utilized as a primary measurement tool and the resulting data were used as a basis of comparison to longer-duration samples (e.g., two-week, four-week (monthly), and 13-week (quarterly) samples).

<sup>149</sup> Standard methods for determining uptake rates have been published by a few organizations. Ideally, the selected passive sampling device will have vendor-supplied uptake rates supported by controlled chamber tests or a considerable body of field-calibrated uptake rates for most, if not all, of the target compounds.

weighted average concentrations. However, similar to active sorbent sampling, the duration of passive sampling must be such that the adsorptive capacity of the media is not approached or exceeded, else the time-weighted average concentration will be biased low by an unknown amount.

One potential disadvantage of sorbent sampling, compared to canister sampling, is that only one analysis is possible from an individual device, because it does not collect a “whole air” sample. Thus, if an error occurs in laboratory handling or there is an instrument malfunction, the sample is lost. Such errors generally are not common. Therefore, this potential disadvantage will not generally offset the benefits of sorbent sampling, the foremost of which is the ability to obtain time-integrated samples over longer periods (i.e., up to a few months for some compounds) than with evacuated canisters.

For a typical-size residential building or a commercial building less than 1,500 square feet, EPA recommends that the site teams generally collect one time-integrated sample in the area directly above the foundation floor (basement or crawl space) and one from the first floor living or occupied area, at least for the initial sampling round.<sup>150</sup> In general, EPA recommends samples be collected at the breathing zone level for the most sensitive exposed population.<sup>151</sup>

EPA recommends the site planning and data evaluation team discuss the number of sample locations per building for atypical situations, which include: (1) very large homes or buildings;<sup>152</sup> (2) multi-use buildings, particularly ones with segmented areas that are occupied by different populations (e.g., day care with young children versus office with adult workers) or have different occupancy patterns over time. Additional samples may also be warranted, depending on internal building partitions, HVAC layout, contaminant distribution in the subsurface, and occurrence of observable locations of potential soil gas entry (e.g., basement sumps or drains, relatively large holes or spaces in the foundation floor, entry points for utilities). Closed rooms located below ground may have appreciably higher contaminant concentrations originating from vapor intrusion. Closed rooms may warrant sampling to characterize the reasonably maximum exposure levels, if occupied, or to diagnose vapor intrusion (e.g., see below), even if not occupied.

---

<sup>150</sup> Placement of indoor air sampling devices may entail compromises. Whereas the ideal location may be a central location that is unobstructed and representative of the actual used area of a room, placement at breathing zone height in a heavily used area well away from any wall is likely to interfere with normal occupant activities.

<sup>151</sup> The “most sensitive” exposed population may be identifiable by combining information about the types of human occupants in a given building and the types of potential toxic effects for vapor-forming chemicals found in the subsurface environment. For example, the ‘most sensitive’ exposed population could be children, pregnant women, or elderly adults, depending upon building- and chemical-specific characteristics.

<sup>152</sup> Larger commercial and residential buildings (e.g., multi-family residences) may warrant additional discussion with the site planning team and perhaps a statistician to select the appropriate number and placement of indoor air samples to meet DQOs.

Indoor air concentrations vary over time, due to time-dependent changes in soil gas entry rates, exchange rates, intra-building mixing, among other factors (see Section 2).<sup>153</sup> Therefore, multiple rounds (and often several rounds) of indoor air sampling is generally recommended in order to reduce the chance of reaching a false-negative conclusion (i.e., concluding exposure is at an acceptable risk level when it is not) or reaching a false-positive conclusion (i.e., concluding exposure is at an unacceptable risk level when it is not).<sup>154</sup> Also, multiple sampling events generally are considered necessary to account for seasonal variations in climate and the habits of building occupants and ensure that related risk management decisions are based upon a consideration of a reasonable maximum vapor intrusion condition.<sup>155</sup> In many geographic areas in the continental United States, indoor air sampling during the heating season may yield higher indoor air concentrations than at other periods, because stack effects are generally more significant and, therefore, higher rates of soil gas entry are reasonably expected. Another scenario that may yield higher indoor air concentrations is when a building is sealed and the ventilation system is not operating.

When sampling indoor air (or sub-slab soil gas), EPA generally recommends removing potential indoor sources of vapor-forming chemicals (see Section 2.7) from the building to strive to ensure that the concentrations measured in the indoor air samples are attributable to the vapor intrusion pathway.<sup>156</sup> After removal of indoor sources, their effects may linger longer depending on source strength, relative humidity inside the building, the extent to which the contaminants have been absorbed by carpets and other fabrics or “sinks,” and air exchange rate of the building. In residential settings, EPA generally recommends that potential indoor sources be removed from the structure and stored in a secure location at least 24 to 72 hours prior to the start of sampling, based on an approximate air exchange rate of 0.25 to 1.0 per hour in

---

<sup>153</sup> Because weather conditions and building operations can lead to time-variable contributions from vapor intrusion (e.g., driving forces for vapor intrusion; see Section 2.3) and ambient air infiltration (see Sections 2.4), indoor air concentrations of vapor-forming chemicals can be expected to vary over time. Holton et al. (2013ab) obtained and reported a set of long-term, high-frequency, indoor air data for an unoccupied house (except for periodic visits by researchers) in Utah overlying a plume of chlorinated hydrocarbons. TCE concentrations in indoor air varied by approximately two to three orders of magnitude, exceeding variations in measured air exchange rate.

<sup>154</sup> An individual sample, collected at a randomly chosen time, may under-estimate average and reasonable maximum exposure conditions. From their high-frequency, measured data, Holton et al. formulated a synthetic data set (simulating one-day-average concentrations), which they used to estimate that a single, randomly drawn, one-day sample had a forty percent chance of being less than the true mean (Holton et al. 2013b; see Table 1 therein). When the true mean was assumed to exceed the risk-based action level (“target concentration” in their parlance) by two or five times, they estimated that a single, randomly drawn, one-day sample had a twenty percent or six percent chance, respectively, of not detecting the exceedance. These data support EPA’s recommendation to collect multiple rounds of indoor air sampling to reduce the chance of reaching a false-negative conclusion. Collecting multiple rounds of indoor air sampling can also reduce the chance of reaching a false-positive conclusion (i.e., concluding that vapor intrusion poses unacceptable human health risk when it does not), because an individual sample, collected at a randomly chosen time, may over-estimate the average exposure condition.

<sup>155</sup> Given EPA’s over-arching duty to protect human health and recognizing the disruption to building owners and occupants caused by indoor air sampling, risk managers may choose to pursue pre-emptive mitigation (i.e., early action) at some buildings (see Sections 3.3 and 7.8) rather than, for example, conduct multiple rounds of sampling over a few years to establish an estimate of long-term average exposure concentration and characterize temporal variability.

<sup>156</sup> Vapor-detecting field instruments and in-field gas chromatographs can be used to locate indoor sources of vapors. For example, Gorder and Dettenmaier (2011) reported on the use of a field-portable gas chromatograph and mass spectrometer to identify specific sources of vapor-forming chemicals. EPA’s Environmental Response Team has employed the Trace Atmospheric Gas Analyzer (TAGA) mobile laboratory for similar purposes.

residential buildings. In residences with attached garages, keeping the door(s) between the garage and the living space closed prior to and during indoor air sampling may also be warranted, in situations where the site-specific chemicals of potential concern include petroleum hydrocarbons or are components of products stored in the garage.

Diagnose Vapor Intrusion and Background Sources. When access is granted for indoor air sampling, EPA generally recommends concurrently collecting samples of sub-slab soil gas (see Section 6.4.3) and outdoor (ambient) air (see Section 6.4.4) over similar durations using the same methods. Comparing these results to each other and to results for subsurface vapor sources can foster insights and support findings about the relative contribution of vapor intrusion and background sources to indoor air concentrations (as described in Section 6.3.5). In this case, time-integrated sampling methods are recommended for indoor air, because concentrations of vapor-forming chemicals can vary significantly over time (see Section 2.6).

Grab (essentially short-duration) samples can, however, be useful for:

- confirming the presence of a subsurface contaminant in indoor air<sup>157</sup> (see Section 6.3.4) or in gas in a drain line or sewer lateral that enters a building,
- identifying specific vapor-forming chemicals emanating from indoor sources of consumer or commercial products<sup>158</sup> (see Section 6.3.5), and
- identifying specific vapor-forming chemicals emanating from suspected openings for soil gas entry into buildings (see Section 6.3.3).

Grab samples can provide a convenient and less intrusive means of confirming the presence, if any, of a site-related subsurface contaminant(s) in the indoor environment. However, an individual grab sample is not reliable for purposes of demonstrating that vapor intrusion is not occurring in a specific building; among other considerations, vapor intrusion and indoor air concentrations can exhibit significant temporal variability (EPA 2012f, Holton et al., 2013ab). Consequently, EPA recommends collecting multiple time-integrated samples to support any such building-specific determination.

Indoor air samples can also be concurrently collected for radon testing, which may be useful in evaluating building susceptibility to soil gas entry (see Section 6.3.3).

Evaluate and Develop Analyte Lists. EPA recommends the site planning and data evaluation team generally limit chemical analyses to those vapor-forming chemicals known (based upon subsurface contaminant characterization) or reasonably expected (based upon site history) to be present in the subsurface environment. For example, if the site history and reliable subsurface sampling data do not identify benzene as a subsurface contaminant, it would be appropriate for site managers to exclude benzene as a target analyte for indoor air samples. Benzene could originate indoors as a result of a car, lawnmower, or snow blower in a garage. In

---

<sup>157</sup> For this purpose, EPA generally recommends collecting one sample directly above the foundation floor (e.g., basement or crawl space) and one from the first floor living or occupied area.

<sup>158</sup> For characterizing indoor sources or openings for soil gas entry, one round of grab sampling of indoor air may be sufficient.

this hypothetical case, benzene would not typically be amenable to reduction by vapor mitigation systems or subsurface remediation efforts. In fact, requesting an extensive list of analytes that are not related to subsurface contamination may unnecessarily complicate risk communication if indoor air testing reveals volatile chemicals unrelated to vapor intrusion.

Collect Complementary Data While Indoors. A variety of useful information can be gathered during a building survey conducted in advance of or during indoor air sampling. EPA recommends that the following complementary data be gathered by observation, interviews, or reports (e.g., mechanical test-and-balance reports) when buildings are to be sampled to analyze indoor air:

- Building Occupancy
  - Characteristics and locations of building occupants (e.g., residents, including children or other sensitive populations; expectations for presence of general public in commercial or industrial settings; presence of multiple exposure units – due to different uses or activities and occupants – within a building other than a single-family residence).
  - Hours of building occupancy under current conditions (and reasonably expected future conditions, as appropriate), particularly for a nonresidential setting. Because this information is pertinent to the human health risk assessment and data evaluation, EPA recommends considering hours of building occupancy when establishing the sampling duration for characterizing indoor air exposure levels.
- Susceptibility to Soil Gas Entry Under Current Conditions
  - EPA recommends that the pressure difference between the indoors and the subsurface be measured whenever indoor air samples are collected. Ideally, differential pressure data would be collected continuously starting several days before sampling and throughout the sample collection period.<sup>159</sup> The magnitude and direction of the pressure difference during sampling can support insights about whether a ‘driving force’ for vapor intrusion is present during indoor air sampling; if not, then the resulting sampling data are unlikely to characterize a reasonable maximum vapor intrusion exposure condition. Differences in driving forces (direction or magnitude) among indoor air sampling events may help to explain any significant differences in observed indoor air concentrations over time.<sup>160</sup> Measuring pressure difference between the indoors and the subsurface

---

<sup>159</sup> These data can be collected using portable pressure monitors installed in a dedicated sub-slab probe at one or more locations. Pressure transducers were employed for this purpose during high-frequency sampling as part of a research study in Indianapolis (EPA 2012f, see Section 3.6.6 therein); readings were recorded every 15 minutes. Technical information about pressure-measuring instruments (e.g., description, operation, and calibration) can be found in Section 4 of *Technical Guidance Document: Compliance Assurance Monitoring* (EPA 1998).

<sup>160</sup> Pre-mitigation measurements of the pressure difference between indoors and the subsurface may also be useful for supporting design of active depressurization technologies to reduce vapor intrusion (EPA 1993a, see Section 3 therein).

is a more direct means of assessing building under-pressurization than is monitoring weather/climate factors (e.g., air temperature, wind speed). Pressure difference monitoring in large buildings can help identify any areas with significant under-pressurization.

- Presence and operation of a mitigation system, which would generally be expected to mitigate intrusion of vapor-forming chemicals even if designed for radon.
- Physical conditions that indicate potential openings to soil gas entry (e.g., potential conduits, such as cracks or floor drains; presence of structures such as utility pits, sumps, and elevators; basements or crawl spaces; modifications to the original foundation).
- Building Heating, Ventilation, and Cooling
  - Building ventilation, including zones of mechanical influence and stagnation. As noted in Section 2.4, greater ventilation is intended to result in smaller vapor concentrations in indoor air. Any non-ventilated or passively ventilated rooms (such as mechanical rooms) may be subject to greater accumulation of vapors. For commercial and industrial buildings, each distinct zone of influence may warrant sampling, when indoor air testing is selected as part of a site-specific investigation plan for vapor intrusion assessment.
  - Operating characteristics of HVAC systems. In many commercial buildings, the HVAC system brings outdoor air into the building, potentially creating building over-pressurization relative to the outdoor environment. EPA recommends noting any areas with significant over-pressurization, relative to the outdoors.
- Indoor and Outdoor Sources of Vapor-Forming Chemicals
  - Chemicals and consumer products used or stored within the building that can act as potential sources of toxic vapors. Vapor-forming chemicals are used in many commercial and most industrial buildings.<sup>161</sup> As noted in Section 2.7, consumer products that can emit vapors may be common in residential buildings. In some circumstances, a photoionization detector (PID) can be used to directly screen the building for locations with vapor-forming chemicals and materials; however, the PID may not be sensitive enough for very low concentration sources. More sensitive options include use of the HAPSITE gas chromatograph/mass spectrometer (Gorder and Dettenmaier 2011) or the TAGA Mobile Laboratory (EPA-ERT 2012).
  - HVAC systems that bring outdoor air into the building potentially bring contaminated outdoor air into the building, depending on the location of the vent and exhaust with regard to other spaces. For example, HVAC intakes adjacent to

---

<sup>161</sup> Depending upon its history of uses and operations, buildings undergoing renovation, redevelopment or reuse may have lingering presence of vapor-forming chemicals due to a past release(s) also.

or near a dry-cleaning facility may introduce vapors of the dry-cleaning solvent into the building.

- In some cases, contaminated groundwater seeps into or actively collects in the building (for example, in sumps), possibly serving as a direct source of vapors. It may be appropriate to collect water samples concurrently with indoor air (and any sub-slab) samples in these circumstances.
- Presence and operation of any indoor air treatment system (e.g., in-line carbon adsorption) that can reduce indoor exposure levels of vapor-forming chemicals.

In general, EPA recommends that the foregoing complementary information be collected during investigation planning and scoping to help determine where to sample and prioritize or sequence buildings for testing. Then, the information can be confirmed during indoor sampling.

Field experience in residential settings suggests that it may not be possible to remove all indoor sources of vapor-forming chemicals. It may be particularly impractical to do so in industrial settings where vapor-forming materials are used or stored. It may also be impractical when deploying passive samplers, owing to their longer deployment period. Therefore, EPA recommends asking building occupants to document indoor sources (and relevant building operations) during indoor air sampling, using an activity log or questionnaire.

#### 6.4.2 Outdoor Air Sampling

Outdoor air concentration data can be useful in identifying potential contributions to indoor air concentrations from ambient air sources (see Section 6.3.5). Therefore, EPA generally recommends collecting ambient air samples using similar sampling and analysis methods, whenever indoor air samples are collected. Normally, EPA recommends one or two outdoor air sample locations to characterize the conditions surrounding a single or a few buildings.<sup>162</sup> Additional outdoor air samples may be warranted if the investigation is assessing multiple buildings over a wide area. EPA also recommends that sample locations be designed to characterize representative conditions in the absence of site-related subsurface contamination (e.g., avoid collecting ambient air samples near locations of known or suspected chemical release(s), including any atmospheric releases from remediation equipment). It also is suggested that observable potential outdoor sources of pollutants (e.g., air emissions from nearby commercial or industrial facilities) be recorded during all building surveys.

Because concentrations of vapor-forming chemicals in ambient air can vary with time, EPA recommends that ambient air samples generally be collected over the same sampling period as indoor air, which will facilitate data evaluations when contaminant concentrations are compared between media. For residential buildings, EPA generally recommends beginning ambient air sampling at least one hour, but preferably two hours, before indoor air monitoring begins and continuing to sample until at least 30 minutes before indoor monitoring is complete. EPA recommends this practice because most residential buildings have an hourly air exchange rate in the range of 0.25 to 1.0, causing air that enters the building before indoor air sampling to

---

<sup>162</sup> For buildings where outdoor air is mechanically brought into the building, an outdoor sample may be co-located near the HVAC intake.



remain in the building for a long time (for example, see Section D.10, ITRC 2007a). Recommended lag times may warrant adjusting for nonresidential buildings.

Evaluate and Develop Analyte Lists. To characterize potential concentrations entering a building via ambient air, EPA generally recommends that chemical analyses for ambient air samples be limited to those vapor-forming chemicals known (based upon subsurface testing) or suspected (based upon site history) to be present in the subsurface environment. Requesting an extensive list of analytes that are not related to subsurface contamination, as discussed previously, may unnecessarily complicate risk communication.

Consider Collecting Complementary Data. Monitoring air exchange during ambient air sampling events can provide useful complementary data. Ideally, these data would be collected continuously starting before sampling and throughout the sample collection period. Information about air exchange can support insights about the amount of ambient air infiltration during sampling.

### 6.4.3 Sub-slab Soil Gas Sampling

Sub-slab sampling is intended to draw soil gas from the air space immediately below the floor slab of a building. Depending upon building construction and condition, this air space may be an air gap that forms beneath a concrete foundation due to differential settlement over time or a pore space within a granular layer that may have been placed below the concrete slab. Access to this air space is generally provided by drilling or coring through the concrete and inserting a probe, which is sealed into the floor. EPA's Environmental Response Team has developed a standard operating procedure for constructing and installing sub-slab soil gas sampling probes (EPA-ERT 2007).

Sub-slab soil gas samples can provide useful data for characterizing the levels of hazardous, vapor-forming chemicals that can enter a building via soil gas intrusion. When combined with other soil gas data, sub-slab soil gas data can be used to assess whether the subsurface vapor migration route is complete (i.e., subsurface vapor migration is capable of transporting hazardous vapors from the source to building; see Section 6.3.2). When combined with an appropriate attenuation factor (e.g., a conservative generic value – see Section 6.5.3), sub-slab soil gas data can be used to estimate a potential upper-bound indoor air concentration<sup>163</sup> that may arise from vapor intrusion. In this way, sub-slab data can be used to assess the potential for the vapor intrusion pathway to pose a health concern.<sup>164</sup>

---

<sup>163</sup> For purposes of this Technical Guide, the term “upper bound indoor air concentration” is intended to be a semi-quantitative phrase, referring to the high end of the exposure distribution. EPA recommends basing the decision about whether to undertake response action for vapor intrusion (i.e., a component of risk management) on a consideration of a “reasonable maximum exposure” (e.g., EPA 1989, 1991a), which is intended to be a semi-quantitative phrase, referring to the lower portion of the high end of the exposure distribution (see Glossary). Alternatively, a “worst case” or “reasonable worst case” (see Glossary) indoor air concentration would refer to the upper portion of the exposure distribution. Section 6.6, which discusses mathematical modeling of vapor intrusion, notes that consideration of a “worst case” exposure condition may be particularly useful where the predicted “worst case” indoor air concentrations can be shown to pose acceptable human health risk.

<sup>164</sup> The sub-slab soil gas concentration provides only half of the information for estimating vapor flux into a building. The other information needed is the soil gas flow rate ( $Q_{\text{soil}}$ ), which is embodied in the attenuation factor. The soil gas flow rate can also be explicitly calculated using a model.

Field experience indicates there may be substantial spatial variability in sub-slab soil gas concentrations even over an average-sized footprint of a residential building. EPA, therefore, recommends site planning and data review teams consider collecting multiple samples per building when sub-slab soil gas sampling is conducted.<sup>165</sup> Three sub-slab samples have been collected in a number of EPA investigations of a typical size residential building or commercial building less than 1,500 square feet in area. EPA recommends the site planning and data evaluation team discuss the number of sample locations per building for atypical situations, which include: (1) very large or small homes or buildings;<sup>166</sup> (2) buildings with more than one foundation floor type;<sup>167</sup> (3) subsurface structures or conditions that might facilitate or mitigate vapor intrusion; and 4) multi-use buildings with distinct segmented areas that differ significantly by occupying population or exposure frequency. In addition, EPA recommends multi-point sub-slab samples be considered to support data interpretation and resolve uncertainties that may arise when:

- There are fewer surrounding buildings that are being sampled (that could have helped the understanding of typical sub-slab values and variability).<sup>168</sup>
- The indoor and sub-slab concentrations for a specific building(s) are out of line with expectations based on data from neighboring homes and other information.

EPA generally recommends that sub-slab sampling include centrally located sub-slab samples in buildings identified for testing when the subsurface vapor source is laterally extensive relative to the building footprint (e.g., a broad plume of contaminated groundwater).<sup>169</sup> In addition, EPA recommends that site teams consider internal building partitions, HVAC layout, contaminant distribution, utility conduits, and openings for preferential soil gas entry in selecting any additional locations for collecting sub-slab samples.

Several rounds of sampling are generally recommended to develop an understanding of temporal variability of sub-slab soil gas concentrations, particularly when these data are used with the recommended attenuation factor (see Section 6.5.3) to estimate a potential upper-bound indoor air concentration that may arise from vapor intrusion.

---

<sup>165</sup> An individual sample, collected at a randomly chosen time, may under-estimate or over-estimate average subslab conditions. Collecting multiple subslab soil gas samples can, therefore, reduce the chance of reaching a false-negative conclusion (i.e., concluding subsurface vapor source strength is limited, when vapor intrusion actually poses an unacceptable human health risk) or a false-positive conclusion (i.e., concluding subsurface vapor source strength is unacceptably elevated, when vapor intrusion actually poses an acceptable human health risk).

<sup>166</sup> For larger structures, a statistician may assist in identifying the number and placement of sampling ports to meet the desired DQOs.

<sup>167</sup> In basements with a partial slab, but one large enough to allow vapors to accumulate (for example, if the slab covers more than 50 percent of the building footprint), EPA generally recommends that one sub-slab port be installed on the slab portion and an indoor air sample be collected directly over the dirt portion.

<sup>168</sup> In these cases, EPA recommends multiple ports be installed in a specific percentage (e.g., more than 10 percent) of the buildings sampled to provide a check for variability in the study area.

<sup>169</sup> Based on work conducted in New York as of the spring of 2010, it appears that the sub-slab concentrations beneath the central area of a home are usually (75 percent of the time) higher than (or as high as) the concentrations closer to the perimeter of the home. This field observation is supported by modeling results for idealized scenarios, which show greater sub-slab soil gas concentrations near foundation centers in under-pressurized residential buildings when the vapor source is laterally extensive relative to the building footprint (EPA 2012b).

If a site team decides to proceed with sub-slab sampling, EPA recommends that leak-testing be performed to ensure the hole is properly sealed, for example through the use of a helium tracer gas shroud. Because installing soil gas probes can disturb subsurface conditions, EPA recommends that the site team allow some time after the sampling probe has been installed for the subsurface to return to equilibrium conditions. An EPA study of the time needed for the subsurface conditions to come back to equilibrium (equilibration rate) after they have been disturbed by installation of the soil gas probes found that an equilibration time of two hours generally was sufficient because most sub-slab material consists of sand or a sand-gravel mixture—even for buildings built directly on clay (Section 5.0, EPA 2006b).

There also may be special considerations for sub-slab soil gas samples because of either a unique construction (for example, pretension concrete slab) or environmental situation. Key EPA recommendations include, but are not limited to:

- Identify the location of cables in post-tensioned concrete (e.g., using ground-penetrating radar) before sub-slab sampling, as drilling through a cable poses a significant health and safety concern and may damage the slab.
- Avoid locating sub-slab samples in areas where groundwater might intersect the slab.
- Identify and avoid the location(s) of underground utilities and structures (for example, electric, gas, water, or sewer lines) to prevent damage to these lines; however, sample collection in close proximity to these lines may be warranted as building penetrations for these lines may pose openings for soil gas entry.
- Consider whether to augment sub-slab samples with samples through the basement walls, as the primary entry points for vapors in basements might be through the sidewalls rather than from below the floor slab.

Evaluate and Develop Analyte Lists. To characterize potential concentrations entering a building via soil gas, EPA generally recommends that chemical analyses for sub-slab soil gas samples be limited to those vapor-forming chemicals known (based upon subsurface testing) or suspected (based upon site history) to be present in the subsurface environment. Requesting an extensive list of analytes that are not related to subsurface contamination, as discussed previously, may unnecessarily complicate risk communication.

Collect Complementary Data While Indoors. When sub-slab soil gas samples are collected, EPA recommends that the following complementary information be gathered by observation or interviews:

- Physical conditions and characteristics that are pertinent to assessing the building's susceptibility to soil gas entry, if any (e.g., potential conduits, such as cracks or floor drains; presence of structures, such as utility pits and elevators; basements or crawl spaces). Such information may help interpret spatial differences in sub-slab or indoor air concentrations within a building.
- Areas with potentially significant over- or under-pressurization relative to the outdoors. Such information may assist in interpreting spatial differences in sub-slab or indoor air concentrations within a building.

- Where outdoor air is mechanically brought into the building by the HVAC system and building(s) interiors are over-pressurized, it may be helpful to also collect ambient air samples to support interpretations of the sub-slab sampling results. If the predominant vapor-forming substances and their respective concentrations in sub-slab soil gas and outdoor air samples are similar, then ambient air may be influencing sub-slab soil gas conditions.

EPA recommends that the pressure difference between the indoors and the subsurface be measured whenever sub-slab soil gas samples are collected. Ideally, differential pressure data would be collected continuously starting several days before sampling and throughout the sample collection period.<sup>170</sup> EPA recommends measuring pressure at locations away from where sub-slab sampling probes are installed to avoid any pressure artifacts caused during purging and sampling. The magnitude and direction of the pressure difference during sampling can support insights about whether a driving force for vapor intrusion is present during sampling.

When any sub-slab soil gas sample is collected, EPA recommends that relevant meteorological data that can influence soil gas concentration patterns at the time of sampling, such as wind speed, snow or ice cover, significant recent precipitation, and changes in barometric pressure, be recorded, using direct observation (e.g., for snow or ice cover) or readily available data sources (e.g., regional weather stations). These data may be helpful qualitatively in data interpretation; for example, in reconciling soil gas data collected on multiple occasions.

A potential shortcoming of sub-slab soil gas testing is that gaining access may be difficult (or, in some cases, infeasible). This difficulty can often be overcome by implementing a program of community outreach and engagement that fosters trust and good relationships (see Section 9.0).

When access is granted for indoor sampling, EPA recommends collecting sub-slab and indoor air samples contemporaneously using similar sampling and analysis methods and sampling durations to allow for data comparison. The sub-slab sampling ports can be installed after the indoor air sample is deployed and collected (8 - 24 hours later) to avoid biasing the indoor air concentrations with potentially higher sub-slab gas infiltration rates during port installation. Alternatively, the sub-slab ports may be installed prior to indoor air sampling and sampled concurrently with the indoor air samples, provided sufficient time is allowed for the indoor air concentrations to return to “normal” after installation of the sub-slab port.<sup>171</sup>

---

<sup>170</sup> These data can be collected using portable pressure monitors installed in a dedicated sub-slab probe at one or more locations. Pressure transducers were employed for this purpose during high-frequency sampling as part of a research study in Indianapolis (EPA 2012f, see Section 3.6.6 therein); readings were recorded every 15 minutes. Technical information about pressure-measuring instruments (e.g., description, operation, and calibration) can be found in Section 4 of *Technical Guidance Document: Compliance Assurance Monitoring* (EPA 1998).

<sup>171</sup> EPA generally recommends delaying indoor air testing for at least 24 to 72 hours based on an approximate air exchange rate of 0.25 to 1.0 per hour. Note that the effects of any ‘spike’ in indoor air concentration may linger depending on source strength, relative humidity inside the building, and the extent to which the contaminants have been absorbed by carpets and other fabrics or “sinks.”

#### 6.4.4 Soil Gas Sampling

Data obtained from a soil gas survey can be used to identify, locate, and characterize subsurface vapor sources (see Section 6.3.1) and characterize subsurface vapor migration routes, including any impedances from geologic, hydrologic, or biochemical conditions (see Section 6.3.2). Soil gas survey data can also be useful in supporting the design of soil vapor extraction systems and other subsurface remediation systems and the performance assessment of these systems (see Section 8.1). For each of these purposes, EPA recommends that soil gas survey data be supported by site-specific geologic information (i.e., site geology and subsurface lithology).

Soil gas sampling generally consists of installing a probe into the ground, drawing gas out of the probe, and collecting the gas for transport to a location for analysis. Inert materials (e.g., stainless steel, copper, brass, polyvinyl chloride, high-density polyethylene) are recommended for constructing soil gas probes. To ensure that data collected are representative of conditions *in situ* (e.g., are not adversely impacted by artificial infiltration of ambient air), a reliable seal of the annulus between the probe and the probe housing and leak testing for the seal are generally recommended. In addition, purging of the probe before collecting the soil gas sample is recommended, analogous to purging of monitoring wells before collecting groundwater samples. EPA's Environmental Response Team has developed a standard operating procedure for soil gas sampling, including constructing and installing sampling probes (EPA-ERT 2001c).

Typically, grab (rather than time-integrated) samples are collected when sampling soil gas. EPA recommends that the site team allow some time after the sampler has been installed for the subsurface to return to equilibrium conditions because installing temporary or permanent soil gas probes can disturb subsurface conditions. The equilibration time may depend on the degree of soil disturbance during installation, which is influenced by the type of drilling techniques used to install the soil gas probes (e.g., with more time needed for auger drilling compared with hand drilling). For example, the California Environmental Protection Agency recommends an equilibration time of two hours for temporary driven probes and 48 hours for probes installed using augered borings (CalEPA 2012).

EPA recommends documenting wind direction, precipitation information, temperature, and other site-specific information that can influence soil gas concentration patterns at the time of sampling, using readily available data sources. These data may be helpful qualitatively in data interpretation; for example, in reconciling soil gas data collected on multiple occasions or assessing concordance of sampling data from various media, when not collected contemporaneously.

EPA recommends that soil gas samples be taken as close to the areas of interest as possible and preferably from directly beneath the building structure. As vapors are likely to migrate upward through the coarsest or driest material in the vadose zone, EPA recommends that soil gas samples be collected from these materials.

Using vertical boring or drilling techniques, it is generally practical to collect soil gas samples only in locations exterior or adjacent to a building's footprint ("exterior" soil gas samples). Modeling results for idealized scenarios show that, in homogeneous soil, soil gas concentrations tend to be greater beneath the building than at the same depth in adjacent open areas when the vapor source is underneath the building, even if the source is laterally extensive relative to the building footprint (e.g., broad plume of contaminated groundwater) (EPA 2012b). Given these

predictions and supporting field evidence (EPA 2012a, see Figure 6; Luo et al. 2009; Patterson and Davis 2009, see Figure 1), individual exterior soil gas samples cannot generally be expected to accurately estimate sub-slab or indoor air concentrations. This potential limitation may be particularly valid for shallow soil gas samples collected exterior or adjacent to a building footprint. On the other hand, when the subsurface vapor source is not underneath the building, "exterior" soil gas samples collected from depths below a building's foundation and along the side of the building closest to the source may be useful for characterizing a reasonable worst case condition underneath the building in the absence of routes for preferential vapor migration or soil gas entry.

Deeper soil gas samples collected in the vadose zone immediately above the source of vapor contamination (i.e., "near-source" soil gas samples; see Section 6.3.1) can reasonably be expected to be less susceptible to the diluting effects of ambient air, compared to shallow soil gas samples. On this basis, deeper soil gas samples collected in the vadose zone immediately above the source of vapor contamination will tend to be more suitable than will be shallow soil gas samples for assessing vapor concentrations that may be in contact with the building's sub-slab.<sup>172</sup> Several rounds of sampling are generally recommended to develop an understanding of temporal variability of "near-source" soil gas concentrations, particularly when these data are used with the recommended attenuation factor (e.g., a conservative generic value – see Section 6.5.3) to estimate a potential upper-bound indoor air concentration that may arise from vapor intrusion.<sup>173</sup>

#### 6.4.5 Groundwater Sampling

Groundwater sampling and analysis also feature prominently in many vapor intrusion investigations, for example, to help characterize plumes that can serve as vapor sources. Groundwater sampling methods are not discussed here because practitioners typically are relatively experienced and trained to collect samples that meet site-specific data quality needs (see, for example, EPA-ERT 2001a). However, Section 6.3.1 provides a few recommended guidelines for groundwater sampling that are pertinent for characterizing representative vapor source concentrations for vapor intrusion assessment. One key consideration in sampling groundwater for vapor intrusion investigations is focusing on characterizing water table

---

<sup>172</sup> Luo et al. (2009) also point to the shortcomings of relying on exterior sampling data, citing significant differences in vapor concentrations and soil gas composition between interior and exterior sampling locations at a maintenance warehouse located at a former refinery. They also observed that the spatial variability in the soil-gas distribution was smaller for soil-gas samples drawn from the source zone, suggesting greater confidence in the assessment of source zone or "near source" vapor concentrations.

<sup>173</sup> For purposes of this Technical Guide, the term "upper bound indoor air concentration" is intended to be a semi-quantitative phrase, referring to the high end of the exposure distribution. EPA recommends basing decisions about whether to undertake response action for vapor intrusion (i.e., a component of risk management) on a consideration of a reasonable maximum exposure (e.g., EPA 1989, 1991a), which is intended to be a semi-quantitative phrase, referring to the lower portion of the high end of the exposure distribution (see Glossary). Alternatively, a "worst case" or "reasonable worst case" (see Glossary) indoor air concentration would refer to the upper portion of the exposure distribution. Section 6.6, which discusses mathematical modeling of vapor intrusion, notes that consideration of a "worst case" exposure condition may be particularly useful where the predicted "worst case" indoor air concentrations can be shown to pose acceptable human health risk.

concentrations. EPA recommends that groundwater samples be taken from wells screened (preferably over short intervals) across the top of the water table.<sup>174</sup>

Groundwater data can be compared to the groundwater VISLs (see Section 6.5).<sup>175</sup> When combined with an appropriate attenuation factor (see Section 6.5.3), groundwater data can be used to estimate a potential upper-bound indoor air concentration that may arise from vapor intrusion.<sup>176</sup> In these ways, groundwater data can be used to assess the potential for vapor intrusion from groundwater sources to pose a health concern.

#### 6.4.6 Planning for Building and Property Access

Vapor intrusion investigations generally entail gaining legal access to buildings and properties to conduct sampling. To address this practical and logistical concern during the planning stage, EPA recommends that an access agreement be executed between the property owner, any occupants, and the investigating entity. Section 9.3 provides additional information for addressing building and property access for sampling.

Obtaining and scheduling access to a property and building can be difficult, whether the structure is a commercial or institutional building or a private residence. This potential difficulty can often be overcome by implementing a program of community outreach and engagement that fosters trust and good relationships. EPA recommends conducting public outreach and communication for this purpose considering the site-specific community involvement plan (See Section 9.1).

### 6.5 Overview of Risk-Based Screening

Risk screening for vapor intrusion generally is performed using site-specific data collected via appropriate methods, as described in Section 6.4. In some cases, pre-existing data identified during a preliminary analysis can be deemed reliable and adequate for use in risk-based screening (see Section 5.5).

#### 6.5.1 Objectives of Screening

The primary objective of risk-based screening is to identify sites or buildings unlikely to pose a health concern through the vapor intrusion pathway. Generally, at properties where subsurface concentrations of vapor-forming chemicals (e.g., groundwater or “near source” soil gas concentrations) fall below screening levels (i.e., VISLs), no further action or study is warranted, so long as the exposure assumptions match those taken into account by the calculations and the site fulfills the conditions and assumptions of the generic conceptual model underlying the

---

<sup>174</sup> EPA recommends that, to the extent practical, groundwater samples be collected over a narrow interval (e.g., a few feet or less) just below the water table when the data are to be used for assessing the potential for vapor intrusion.

<sup>175</sup> If available groundwater data do not meet the criteria set forth in Section 6.4.5, the site data review team may judge whether they are nevertheless representative of potential vapor source concentrations emanating from groundwater.

<sup>176</sup> EPA recommends basing decisions about whether to undertake response action for vapor intrusion (i.e., a component of risk management) on a consideration of a reasonable maximum exposure (e.g., EPA 1989, 1991a).

screening levels. In a similar fashion, the results of risk-based screening can help the data review team identify areas, buildings, and/or chemicals that can be eliminated from further assessment.

Subsurface concentrations of vapor-forming chemicals that exceed the VISL for the respective medium (e.g., groundwater, soil gas, subslab soil gas) would not automatically trigger mitigation or subsurface remediation (i.e., they are not offered as response action levels or cleanup levels). Exceeding a subsurface screening level generally suggests, however, that further evaluation of the vapor intrusion pathway is appropriate. In this way, risk-based screening, along with other lines of evidence, can help focus a subsequent site-specific investigation, the results of which would provide support for considering building mitigation and other risk management options (see Section 8.0). For example, the results of vapor source strength screening can help identify and prioritize buildings for indoor testing.

Finally, risk-based screening can also support:

- a preliminary evaluation of human health risk using individual building data (e.g., indoor air concentrations), which would consider the magnitude of the concentration exceedance of the indoor air screening level and site-specific risk management benchmarks (see Section 7.4.1); and
- identification of buildings and structures that may warrant prompt action due to potential explosion threats (see Section 7.5.1).

### 6.5.2 Scope and Basis for Health-based, Vapor Intrusion Screening Levels

EPA developed VISLs for human health protection that are generally recommended, medium-specific, risk-based screening-level concentrations intended for use in identifying areas or buildings that may warrant further investigation of the vapor intrusion pathway. These VISLs are calculated and documented in the VISL Calculator and are based on:

- Current toxicity values selected considering OSWER's hierarchy of sources for toxicity values (EPA 2003).
- Physical-chemical parameters for vapor-forming chemicals.
- EPA-recommended approaches for human health risk assessment (e.g., EPA 2009c, 2014a).

The VISLs for human health protection include indoor air screening levels for long-term (i.e., chronic) exposures, which consider the potential for cancer and noncancer effects of vapor-forming chemicals.<sup>177</sup> The VISLs for human health protection also include subsurface screening levels for comparison to sub-slab soil gas, "near-source" soil gas, and groundwater sampling

---

<sup>177</sup> The VISL Calculator does not include information about radon. Information about characterizing the human health risk posed by radon can be found on-line at: <http://epa-prgs.ornl.gov/radionuclides/>



results. These screening levels are derived from the indoor air screening levels for chronic exposures using medium-specific, generic attenuation factors described further in Section 6.5.3 and Appendix A. The user's guide for the VISL Calculator provides additional information about derivation of the indoor air and subsurface screening levels (EPA 2015a).

The medium-specific VISLs for human health protection are intended to be compared to:

- Building-specific data, such as results from sub-slab soil gas samples, crawl space samples, or indoor air samples; or
- Site- or building-specific data that characterize subsurface vapor sources (e.g., groundwater samples, "near-source" soil gas concentrations)

to determine if there is a potential for the vapor intrusion pathway to pose a health concern to building occupants.

The medium-specific VISLs for health protection are developed considering a generic conceptual model for vapor intrusion consisting of:

- A source of vapors underneath the building(s) either in the vadose zone or in the uppermost, continuous zone of groundwater.
- Vapor migration via diffusion upwards through unsaturated soils from these sources toward the ground surface and overlying buildings.
- Buildings with poured concrete foundations (e.g., basement or slab-on-grade foundations) that are susceptible to soil gas entry.

A critical assumption for this generic model is that site-specific subsurface characteristics will tend to reduce or attenuate soil gas concentrations as vapors migrate upward from the source and into overlying structures. Specific factors that may result in relatively unattenuated or enhanced transport of vapors into a building include the following:

- Significant openings to the subsurface that facilitate soil gas entry into the building (e.g., sumps, unlined crawl spaces, earthen floors) other than typical utility penetrations.<sup>178</sup>
- Very shallow groundwater sources (e.g., depths to water less than five feet below foundation level) (see, for example, EPA (2012a), Section 5.2).
- Significant routes for preferential, subsurface vapor migration whether naturally-occurring (e.g., fractured bedrock) or anthropogenic (see Sections 5.4 and 6.3.2).

---

<sup>178</sup> For purposes of this Technical Guide, the term "significant openings" is intended to refer to forms and amounts of openings, other than adventitious and intentional openings in a building that are expected to typically be present in all buildings (e.g., cracks, seams, interstices, and gaps in basement floors and walls or foundations; perforations due to utility conduits). Such an atypical opening would be "significant" when it is of sufficient volume and proximity to a building that it may be reasonably anticipated to influence vapor migration towards or soil gas entry into the building.

These specific factors are likely to render inappropriate the use of the recommended attenuation factors and the sub-slab, groundwater, and soil gas VISLs for purposes of identifying sites or buildings unlikely to pose a health concern through the vapor intrusion pathway. On the other hand, further evaluation of the vapor intrusion pathway is still appropriate when the sub-slab, groundwater, and soil gas VISLs are exceeded for samples from a building or site where these specific factors are present.

Vapor source types that typically make the use of the recommended attenuation factors and health-based VISLs for groundwater and soil gas inappropriate include:

- Those originating in landfills where methane is generated in sufficient quantities to induce advective transport in the vadose zone.
- Those originating in commercial or industrial settings where vapor-forming chemicals can be released within an enclosed space and the density of the chemicals' vapor may result in significant advective transport of the vapors downward through cracks and openings in floors and into the vadose zone.
- Leaking vapors from pressurized gas transmission lines.

In each case, the diffusive transport of vapors may be overridden by advective transport, and the vapors may be transported in the vadose zone several hundred feet from the source of contamination with little attenuation in concentration.

In general, EPA recommends considering whether the assumptions underlying the generic conceptual model are attained at a given site. If they are not attained, then EPA recommends that the medium-specific VISLs not be relied upon as a line of evidence for identifying sites or buildings unlikely to pose a health concern through the vapor intrusion pathway. Where the assumptions regarding the subsurface attenuation factors do not or may not apply, EPA generally recommends collecting indoor air samples.

As noted in Section 6.5.1, these VISLs are not automatically response action levels, although EPA recommends that similar calculation algorithms be employed to derive cleanup levels (see Section 7.6). Comparison of sample concentrations to the VISLs is only one factor recommended for use in determining the need for a response action at a site. As discussed further in Section 6.5.4, an individual subsurface sampling result that exceeds the respective, chronic screening level does not establish that vapor intrusion will pose an unacceptable human health risk to building occupants. Conversely, these generic, single-chemical VISLs do not account for the cumulative effect of all vapor-forming chemicals that may be present. Thus, if multiple chemicals that have a common, non-cancer toxic effect are present, a significant health threat may exist at a specific building or site even if none of the individual substances exceeds its VISL (see discussion of non-cancer hazard index in Section 7.4.1).

### 6.5.3 Recommended Attenuation Factors for Health-based Screening

Vapor attenuation refers to the reduction in volatile chemical concentrations that occurs during vapor migration in the subsurface, coupled with the dilution that can occur when the vapors enter a building and mix with indoor air (Johnson and Ettinger 1991). The aggregate effect of these physical and chemical attenuation mechanisms can be quantified through the use of a vapor intrusion attenuation factor, which is defined as the ratio of the indoor air concentration

arising from vapor intrusion to the soil gas concentration at the source or a depth of interest in the vapor migration route (EPA 2012a).<sup>179</sup>

EPA compiled a database of empirical attenuation factors for chlorinated VOCs and residential buildings through review of data from 913 buildings at 41 sites with indoor air concentrations paired with sub-slab soil gas, groundwater, exterior soil gas, or crawl space concentrations (EPA 2012a). After removing data that do not meet quality criteria and data likely to be influenced by background sources, the distributions of the remaining attenuation factors were analyzed graphically and statistically.<sup>180</sup> Based upon these analyses, the attenuation factors in Table 6-1 are recommended by EPA to derive the VISLs for health protection.

With the exception of the “near-source” exterior soil gas attenuation factor, the recommended values for residential buildings are the estimated 95<sup>th</sup> percentile values, rounded to one significant figure.<sup>181</sup> The rationale for these recommendations and related analyses are provided in Appendix A. These recommended values are proposed to apply to all vapor-forming chemicals for use in estimating potential upper-bound concentrations in indoor air that may arise from vapor intrusion.<sup>182</sup> The recommended groundwater and “near-source” soil gas attenuation factors do not, however, include the effects of biodegradation.<sup>183</sup> On the other hand, because biodegradation is not expected to occur indoors (i.e., in indoor air in the absence of an air treatment system), the sub-slab soil gas and crawl space attenuation factors are expected to apply equally to vapor-forming chemicals that biodegrade in the vadose zone and those that do not.

As with the medium-specific VISLs, EPA recommends considering whether there are site- or building-specific factors that may result in unattenuated or enhanced transport of vapors toward and into a building, such as the presence of preferential migration route(s) as described in Sections 5.4 and 6.3.2. The presence of such factors is likely to render inappropriate the use of any of these generic attenuation factors.

---

<sup>179</sup> As defined here, the vapor attenuation factor is an inverse measurement of the overall dilution that occurs as vapors migrate from a subsurface vapor source into a building; i.e., lower attenuation factor values indicate lower vapor intrusion impacts and greater dilution; higher values indicate greater vapor intrusion impacts and less dilution (EPA 2012a, b). Johnson and Ettinger (1991) utilized the symbol  $\alpha$  for the vapor intrusion attenuation factor. For example, the subslab soil gas attenuation factor is intended to account for concentration dilution arising during migration through openings in the foundation and from mixing of subsurface contaminants inside the building. The groundwater attenuation factor is intended to account for concentration dilution arising during vapor migration from the groundwater table through the vadose zone, in addition to concentration dilution arising during migration through openings in the foundation and from mixing of subsurface contaminants inside the building.

<sup>180</sup> A summary of the resulting distributions is provided in Appendix A of this document.

<sup>181</sup> The recommended “near-source” exterior soil gas attenuation factor corresponds to approximately the estimated 75<sup>th</sup> percentile value.

<sup>182</sup> EPA recommends basing decisions about whether to undertake response action for vapor intrusion (i.e., a component of risk management) on a consideration of a reasonable maximum exposure (e.g., EPA 1989, 1991a).

<sup>183</sup> Appropriate data can be collected and evaluated, as described in Section 6.3.2, to characterize and document the occurrence of biodegradation in the vadose zone and its effects in attenuating vapor concentrations of biodegradable vapor-forming chemicals.

**TABLE 6-1**  
**RECOMMENDED VAPOR ATTENUATION FACTORS FOR RISK-BASED**  
**SCREENING OF THE VAPOR INTRUSION PATHWAY<sup>184</sup>**

Sampling Medium	Medium-specific Attenuation Factor for Residential Buildings
<b>Groundwater</b> , generic value, <u>except</u> for shallow water tables (less than five feet below foundation) or presence of preferential vapor migration routes in vadose zone soils	1E-03 (0.001)
<b>Groundwater</b> , specific value for fine-grained vadose zone soils, when laterally extensive layers are present <sup>185</sup>	5E-04 (0.0005)
<b>Sub-slab soil gas</b> , generic value	3E-02 (0.03)
<b>“Near-source” exterior soil gas</b> , generic value <u>except</u> for sources in the vadose zone (less than five feet below foundation) or presence of routes for preferential vapor migration in vadose zone soils	3E-02 (0.03)
<b>Crawl space air</b> , generic value	1E-00 (1.0)

The VISL Calculator (<http://www.epa.gov/oswer/vaporintrusion/guidance.html>) also facilitates calculation of groundwater screening levels based on the recommended attenuation factor for fine-grained soil. EPA recommends that any use and application of this semi-site-specific groundwater attenuation factor be supported by site-specific geologic information (i.e., site geology and subsurface lithology). Significant characterization of the vadose zone may be needed to demonstrate that fine-grained layers are laterally extensive over distances that are large compared to the size of the building(s) or the extent of vapor contamination at a specific site, which is the recommended support for using the semi-site-specific attenuation factor for

<sup>184</sup> Use of these attenuation factors for estimating indoor air concentrations is contingent upon site conditions fitting the generic model of vapor intrusion described in Section 6.5.2 and subsurface conditions being characterized considering the recommendations in Sections 6.3 and 6.4.

<sup>185</sup> The Draft VI Guidance allowed for the modification of VISLs for groundwater by incorporating a lower attenuation factor, based upon “some site-specific inputs”, which estimates a greater reduction in vapor concentrations in the vadose zone than the generic value (EPA 2002c, 2010b). In the Draft VI Guidance, graphs were provided from which such “semi-site-specific” attenuation factors could be selected and justified based upon site-specific soil type and depth to the water table. Based upon analysis of EPA’s expanded database, a single groundwater attenuation factor is provided in this Technical Guide for fine-grained soils.

fine-grained soil.<sup>186</sup> For purposes of applying the groundwater attenuation factors, EPA recommends the depth to groundwater be estimated relative to the bottom of the building foundation and be based upon the seasonal high groundwater table.

#### 6.5.4 Comparing Sample Concentrations to Health-based Screening Levels

When evaluating environmental sampling results to assess the vapor intrusion pathway, it is important to first determine that the samples were collected appropriately. Section 6.4 provides information about recommended sampling locations and procedures for vapor intrusion investigations. In addition, EPA recommends collecting and evaluating appropriate site-specific information to demonstrate that the property fulfills the conditions and assumptions of the generic conceptual model underlying the VISLs, as described in Section 6.5.2.

After verifying that the CSM justifies the use of the VISLs, the individual sample concentrations may be compared to the appropriate medium-specific screening levels. In order to select the appropriate target media concentrations for comparison, it generally is important to identify whether a source of vapors for a building or a developed area occurs in the unsaturated zone, which is an important aspect of the CSM. This allows the site data to be segregated into two categories:

- Data representing areas where contaminated groundwater is the only source of contaminant vapors.

In this first case, groundwater VISLs are generally appropriate to use to evaluate groundwater concentrations (also see sampling recommendations in Sections 6.3.1 and 6.4.5). Under these circumstances, EPA recommends that the plume be shown to be stable or shrinking (i.e., is not migrating or rising in concentration, including hazardous byproducts of any biodegradation) to establish that the potential for vapor intrusion to pose a human health risk from vapor intrusion will not increase in the future. “Near-source” soil gas data (i.e., soil gas samples collected immediately above the water table) could also be compared to the soil gas VISLs to obtain a corroborating line of evidence (see recommendations in Section 6.3.1).

When the anticipated outcome of the screening is a finding that groundwater poses acceptable human health risk from vapor intrusion on an area-wide basis, it may be appropriate to compare sampling results for the most greatly impacted well within the area of interest and show that these results are less than the groundwater VISLs.

- Data representing areas where the underlying vadose zone soil contains a source of vapors (e.g., residual NAPL).

In this second case, EPA recommends that only soil gas VISLs be used and compared to results from “near-source” soil gas samples collected near the vapor source zone

---

<sup>186</sup> The general soil type assigned to paired vapor intrusion data in the EPA’s database “generally represents the coarsest soil described in the vadose zone near the sample location” unless “sufficient stratigraphic information was available to indicate finer sediments are laterally continuous” (EPA 2012a). EPA recommends that similar criteria be applied to justifying the use of the semi-site-specific attenuation factor for groundwater (or selection of soil-related parameters for modeling); see Section 6.6. For these purposes, soil classified as clay, silty clay, silty clay loam, or silt consistent with the U.S. Soil Conservation Service classification system can be considered to be “fine-grained.”

(also see sampling recommendations in Sections 6.3.1 and 6.4.4). In this situation, the groundwater VISLs (and vapor attenuation factors for groundwater) are not recommended for estimating potential upper-bound indoor air concentrations, because they have been derived assuming no other vapor sources exist between the water table and the building foundation.

In both cases, because of the complexity of the vapor intrusion pathway, EPA recommends that professional judgment be used when applying the VISLs.

Generally, if all subsurface sample concentrations for a given building or area are less than the respective medium-specific screening level, then vapor intrusion is less likely to pose an unacceptable human health risk to building occupants. On the other hand, when individual sample concentrations exceed the respective screening level, additional assessments may be warranted. So, for example, if a groundwater or “near-source” soil gas concentration exceeds the respective screening level, it is recommended that sub-slab soil gas testing and indoor air testing be conducted.

However, we would note that any individual subsurface sampling result that exceeds the respective, chronic screening level does not establish that vapor intrusion will pose an unacceptable human health risk to building occupants. For one, the subsurface screening levels are expected to be conservative (i.e., are likely to over-estimate the contribution to indoor air levels arising from vapor intrusion) for many buildings due to the use of a high-end attenuation factor (see Section 6.5.3). In many cases, indoor air concentrations arising from vapor intrusion would be expected to be lower than those estimated using the recommended generic attenuation factors. For carcinogens, the screening levels are set using a one-per-million lifetime cancer risk (i.e.,  $10^{-6}$ ), whereas EPA recommends consideration of a cancer risk range when making risk management decisions (see Section 7.4.1). Finally, sampling results can be expected to be variable spatially and temporally and these screening levels assume a long period of exposure at the stated concentration.

Owing to the temporal variability in building-specific data and the potential temporal and spatial variability in soil gas vapor concentrations, EPA generally recommends multiple samples be collected (see Section 6.4) and compared to the respective medium-specific screening level. In addition, the results of risk-based screening are generally most useful when they can be evaluated for indoor air and subsurface vapor sources concurrently and in the context of the CSM. EPA, therefore, generally recommends that multiple lines of evidence be developed and their results weighed together when evaluating and making risk-informed decisions pertaining to vapor intrusion. EPA generally recommends that concordance among the multiple lines of evidence be obtained, particularly when considering a determination that the vapor intrusion pathway is incomplete or does not pose an unacceptable human health risk. Sections 7.1, 7.2, and 7.3 provide additional information and recommendations about developing and using multiple lines of evidence and risk management decision-making.

### 6.5.5 Planning for Communication of Sampling Results

EPA recommends the community involvement or public participation plan (See Section 9.1) describe and address community questions, concerns, and preferences for participation regarding sampling results. Generally, EPA recommends that the site planning team provide validated results to property owners and occupants. These results can be transmitted to relevant parties in a letter, along with a description of what future actions, if any, may be

warranted. In addition, the site planning team may choose to hold a community meeting to discuss the sampling results in general terms and EPA's plans, if any, for response actions. Section 9.4 provides additional information for communicating sampling results.

## 6.6 General Principles and Recommendations for Mathematical Modeling

When suitably constructed, documented, and verified, mathematical models can provide an acceptable line of evidence supporting risk management decisions pertaining to vapor intrusion. In certain situations (e.g., for future construction on vacant properties), it is particularly useful to employ mathematical modeling to predict reasonable maximum indoor air concentrations, because indoor air testing is not possible.

Mathematical modeling is most appropriately used in conjunction with other lines of evidence. For example, in the brownfield development case (i.e., yet-to-be-constructed building), EPA generally recommends these additional lines of evidence include, at a minimum, data that characterize potential subsurface vapor sources and associated geologic and hydrologic conditions in the vadose zone (see Sections 6.3.1 and 6.3.2).

Generally, mathematical models transform empirical values of input parameters into predictions of chemical concentrations in environmental media. The model input parameters are equally as important to the results as the mathematical components of the model (i.e., governing equations and solution algorithms). As a consequence, the results critically depend on the choices for the inputs.

Historically, to assure confidence in predictions of mathematical models, they have been compared to measured, site-specific values. When measured and predicted values do not reasonably match, model input parameters are adjusted through calibration. For example, calibration is commonly used in groundwater flow modeling, in which model-predicted groundwater levels are matched to measured groundwater levels for a baseline condition to gain insight into hydrogeologic properties. The calibrated input parameters must reasonably represent the underlying phenomena and the characteristics of the model must reasonably match the field situation. Calibration of mathematical models is known to be non-unique, so that different sets of parameters can be used to fit the same observed data. This means that calibration does not produce a theoretically correct set of parameters. Because various values of input parameters could be used in the calibrated model, there will always be uncertainty as to the actual values.

Three approaches exist for applying mathematical models in these circumstances:

- 1) Calibrating the mathematical model to the measured indoor air concentration (and, possibly, the sub-slab soil gas concentration) considered to be representative of vapor intrusion (i.e., background vapor sources have been identified and removed prior to sampling and data evaluation indicates that the concentration is reasonably attributable to vapor intrusion). Calibration entails adjusting the input parameters within plausible and realistic ranges so that the predicted indoor air concentrations (or sub-slab soil gas concentrations) are similar to the measured vapor concentrations. The adjusted input parameters can then be compared to site-specific conditions and data to verify that the CSM and calibrated model are coherent and sound.

- 2) Conducting an uncertainty analysis (perhaps using an automated uncertainty analysis (see <http://www.epa.gov/athens/learn2model/part-two/onsite/uncertainty-vi.html> as only one example)) to understand where, within the probability distribution of results, model results with pre-selected default parameters lie. This approach may be particularly useful where indoor air concentrations have not been measured or non-site-specific inputs have been used.
- 3) Using a bounding case analysis, where parameters are chosen to represent conditions that give a high-impact (e.g., “reasonable worst”) case – see Glossary – or “worst” (maximum plausible)<sup>187</sup> case. This approach may be particularly useful where the predicted indoor air concentrations for the bounding case can be shown to pose acceptable human health risk.<sup>188</sup> The range of predicted indoor air concentrations can be established if the analysis also includes a low-impact (“best”) case.

Unless site-specific parameter values are obtained for input parameters and the mathematical model is calibrated to field data, use of default input parameter values will generate model results that lie at an unknown point within an uncertainty band of the model outcomes. Because the combined effect of parameter uncertainty is large, a one- or two-order of magnitude error might be made unknowingly. To reduce these errors, sub-slab vapor sampling could be used to characterize the vapor concentration(s) beneath a building. Model results (i.e., predicted sub-slab soil gas concentrations) that match measured values would have increased confidence. Alternately, using bounding estimates of parameter values could provide a conservative model result that would be expected to represent the reasonable worst case of potential exposure.

Three examples follow where differing applications of mathematical models would be useful in vapor intrusion assessment:

- Verify General Magnitude. Modeling using site-specific inputs can be useful for verifying the general magnitude of measured indoor air sample concentrations, which may allow risk managers to reach supportable conclusions not to conduct additional indoor air testing. In this situation, the model could be calibrated to indoor air measurements and the plausibility of the calibrated input parameters evaluated. If the calibrated model input parameters are plausible, then they can be considered an additional line of evidence supporting risk management decisions.
- Explore Range of Outcomes through Uncertainty Analysis. In certain situations, indoor air testing is not possible (e.g., for future construction on vacant properties) or feasible.

---

<sup>187</sup> For purposes of this Technical Guide, the phrase “worst case indoor air concentration” is intended to be a semi-quantitative phrase, referring to the high end of the exposure distribution. “No-further-action” decisions can normally be supported more confidently when the “worst case indoor air concentration” can be shown to pose acceptable health risks. Under these conditions, the “reasonable maximum exposure” (see Glossary) typically would also pose acceptable health risks.

<sup>188</sup> “Bounding estimates” purposely overestimate the exposure or dose in an actual population for the purpose of developing a statement that the risk is “not greater than...” (EPA 1992c).



Here the range of possible outcomes could be explored with the model through an uncertainty analysis. For example, model input parameters, including building and vadose zone soil properties, could be varied within plausible ranges to determine the parameters to which the model is most sensitive to guide field investigations. Uncertainty analyses can also be used to ascertain whether the subsurface vapor source concentrations are such that indoor air samples would not be expected to contain detectable levels of vapor-forming chemicals arising from vapor intrusion.

- Generate Bounding Estimates. If the range of parameter values is known with confidence for the site, then parameters can be chosen to represent the bounding case of maximum plausible vapor intrusion (i.e., worst case).

In each of these examples, model parameters might vary in space and time because of subsurface heterogeneity, transient hydrologic conditions, or variation in building operation. Thus, there is a need for characterizing spatial and temporal variability.

Mathematical models provide opportunities to predict conditions that cannot be observed directly, but the reliability of the results need to be confirmed, especially when limited site-specific data are available and the model is not calibrated to observed indoor air concentrations. Use of a generic, conservative attenuation factor (see Section 6.5.3) to predict potential, upper-bound indoor air concentrations (based upon soil gas concentrations – see Sections 6.4.3 and 6.4.4) implicitly represents use of a mathematical model, even when the attenuation factor is selected from an empirical data set. Whether the mathematical model is implicit (e.g., generic, conservative attenuation factor) or explicit (e.g., mathematical model that generates a bounding estimate), both analytic approaches make the assumption that site-specific attenuation is likely to be greater and the indoor air concentration(s) is (are) likely to be lower than predicted value(s).

The use of extreme and non-representative assumptions or parameter values is the most common weakness of mathematical modeling for environmental assessments. Mathematical modeling typically yields more reliable results when used with high-quality, site-specific data inputs (that is, representative groundwater or soil gas concentrations, depth to groundwater, soil type and moisture content underneath the building, and the building conditions (e.g., air exchange rate, building mixing height), for example); in these cases, the site-specific data inputs and CSM provide additional lines of evidence supporting the use of mathematical modeling as a line of evidence.

Whenever mathematical modeling is used to make predictions pertaining to vapor intrusion, EPA recommends that the site planning and data team:

- Identify the underlying mathematical model and include appropriate references to document that it has been peer-reviewed.
- Verify that the selected model fits the CSM and is appropriate for the chosen purpose.
- Document all inputs and outputs in a readily recognizable and understandable format.
- Identify the critical parameters and conduct a sensitivity analysis for the most critical parameters.

- Determine and document the appropriate modeling approach (e.g., calibration, uncertainty analysis, bounding case analysis).
- Perform new individual measurements (i.e., field sampling) to confirm one or more results of the modeling.

A critical assumption underlying almost all mathematical models of vapor intrusion is that site-specific subsurface characteristics will tend to reduce or attenuate soil gas concentrations as vapors migrate upward from the source and into overlying structures. Mathematical modeling of vapor intrusion is, therefore, not generally recommended for sites and buildings where unattenuated or enhanced transport of vapors toward and into a building is reasonably expected. Sections 5.4, 6.3.2, and 6.5.2 identify several factors that may result in unattenuated or enhanced transport of vapors toward and into a building.

## 7.0 RISK ASSESSMENT AND MANAGEMENT FRAMEWORK

This section provides general recommendations about risk-informed decision-making pertaining to vapor intrusion. The risk management information described herein presumes that a sound CSM has been developed (see Sections 5.4 and 6.3), which is supported by multiple lines of evidence, and that subsurface vapor sources have been characterized (see Section 6.3.1) sufficiently to support the risk management decisions for the site. EPA also notes that temporal and spatial variability of sampling data can span at least an order of magnitude and often more.

Site-specific decisions potentially supported by the information described in this section include:

- Whether to install engineered exposure controls to prevent or reduce the impacts of vapor intrusion in specific buildings.
- Whether to remediate subsurface vapor sources for the site to reduce risks posed by vapor intrusion.
- Whether the vapor intrusion pathway is incomplete and there is no potential for unacceptable human exposure under current or future conditions.
- Whether to collect additional information as part of the detailed vapor intrusion investigation or monitor indoor air as part of an overall vapor intrusion remedy.

As conditions warrant and resources allow, EPA generally recommends that officials responsible for overseeing cleanups pursuant to RCRA and CERCLA ensure that past decisions pertaining to vapor intrusion continue to be supported by current conditions (EPA 2002b).

Finally, EPA encourages systematic approaches to decision-making, which can foster scientific rigor, consistency, and transparency.

### 7.1 Collect Site-specific Lines of Evidence

Current practice suggests that the vapor intrusion pathway generally be assessed using multiple lines of evidence. As discussed in Sections 5.1, 5.4, 5.5.2, 6.3, 6.4, and 6.5, appropriate lines of evidence to support development of the CSM and evaluate the vapor intrusion pathway may include, but are not limited to:

#### Subsurface Vapor Sources

- Site history and source of the contaminants to demonstrate that vapor-forming chemicals have been or may have been released to the underlying and surrounding subsurface environment and identify the type of vapor source (e.g., vapor-forming chemicals dissolved in groundwater or present in a NAPL).
- Groundwater data (generally recommended from more than one sampling event), as appropriate, to confirm the presence of a water-table aquifer, if present, as a source of vapors and establish its chemical and hydrogeologic characteristics.

- Soil gas data, bulk soil sampling data,<sup>189</sup> and/or NAPL sampling data to confirm the presence of contamination in the vadose zone, if present, as a source of vapors and establish its chemical and physical characteristics.
- Sub-slab (or crawl space) soil gas data to assess concentrations potentially available for entry with any intruding soil gas (generally recommended from multiple sampling events and in multiple locations to reduce the chance of reaching a false-negative conclusion (i.e., concluding subsurface vapor source strength is limited when vapor intrusion actually poses an unacceptable human health risk) or a false-positive conclusion.
- Comparison of groundwater and/or soil gas concentrations to VISLs to evaluate source strength and potential for a health concern if the vapor intrusion pathway is complete.

#### Vapor Migration and Attenuation in the Vadose Zone

- Soil gas survey data, including some level of vertical and spatial profiling, as appropriate, to confirm soil gas migration and attenuation along anticipated routes in the vadose zone between sources and buildings.
- Data on site geology and hydrology (e.g., soil moisture and porosity) to support the interpretation of soil gas profiles, the characterization of gas permeability, and the identification of anticipated soil gas migration routes in the vadose zone or the identification and characterization of impeded migration.
- Vertical profiles of chemical vapors, electron acceptors for microbial transformations (e.g., oxygen), and degradation products (e.g., methane, vinyl chloride) to characterize attenuation due to biochemical (e.g., biodegradation) processes.
- Utility corridor assessment to identify preferential migration routes, if any, that facilitate subsurface vapor migration between sources and towards and into buildings

#### Building Foundation Assessment, Including Susceptibility to Soil Gas Entry

- Building construction and current conditions, including utility conduits or other preferential routes or openings for soil gas entry, heating and cooling systems in use, and any segmentation of ventilation and air handling.
- Instrumental (e.g., PID) readings to locate and identify potential openings for soil gas entry into buildings.

---

<sup>189</sup> As noted in Section 6.4, bulk soil sampling and analysis can be used to characterize the chemical composition and general location of contamination; for example, high soil concentrations generally would indicate impacted soil. On the other hand, non-detect results for soil samples cannot be interpreted to indicate the absence of a subsurface vapor source, because of the potential for vapor loss due to volatilization during soil sampling, preservation, and chemical analysis. Therefore, bulk soil (as opposed to soil gas) sampling and analysis is not currently recommended for estimating the potential for vapor intrusion to pose unacceptable human health risk in indoor air.

- Grab samples of soil gas or indoor air near openings to characterize the composition of presumptive soil gas entering buildings.
- Pressure data to assess the driving force for soil gas entry into building(s) via advection.
- Tracer-release data to verify openings in building foundations for soil gas entry or assess fresh air exchange within buildings.

#### Interior Assessment

- Indoor air sampling data (Section 6.4.1) to assess the presence of subsurface contaminants in indoor air (Section 6.3.4), estimate potential exposure levels to building occupants to support site-specific human exposure and human health risk assessments (see Section 7.4), and otherwise diagnose vapor intrusion and characterize background concentrations (Section 6.3.5).<sup>190</sup>

#### Indoor and Outdoor Sources of Vapor-forming Chemicals Found in the Subsurface

- Building-specific indoor sources of volatile chemicals (Section 2.7).
- Concurrent outdoor air data to assess potential contributions of ambient air to indoor air concentrations (Sections 6.3.5 and 6.4.2).
- Comparative evaluations of indoor air and sub-slab soil gas data (e.g., Section 6.3.5), including calculation and comparison of building-specific, empirical attenuation factors (EPA 2012a, Section 3.0) (e.g., to assess their consistency among subsurface contaminants to assist in identifying indoor vapors arising from vapor intrusion).

#### Additional Supporting Lines

- Results of statistical analyses (e.g., data trends, contaminant ratios) to support data interpretation.
- Results of mathematical modeling that rely upon site-specific inputs (Section 6.6).

The relative utility of these and other individual lines of evidence will depend on site-specific factors, as described and documented in the CSM (Section 5.4), and the objectives of the investigation (Section 6.3). For example:

- When the primary subsurface vapor source is residual NAPL in the vadose zone, bulk soil data would typically be collected to characterize the chemical composition and general location of contamination; for example, high soil concentrations generally would

---

<sup>190</sup> In certain cases, depending in part on the results (e.g., concentrations exceed risk-based screening levels), indoor air sampling data may be a sufficient basis for supporting decisions and recommendations to undertake pre-emptive mitigation (see Sections 3.3 and 7.8) in lieu of additional rounds of sampling and analysis or an evaluation of the contribution of background sources to indoor air concentrations.

indicate impacted soil in the vadose zone, as discussed in Sections 6.3.1 and 6.4.<sup>191</sup> In this situation, “near source” soil gas data, rather than groundwater data, would be recommended for assessing the potential for vapor intrusion to pose an unacceptable human health risk to occupants of any building overlying the NAPL zone. On the other hand, when the subsurface vapor source underneath a building is shallow groundwater, groundwater sampling data from the uppermost hydrogeologic unit would be an appropriate line of evidence for purposes of assessing the potential for vapor intrusion to pose an unacceptable human health risk, unlike the previous example.

- In both of the preceding cases, information about the soil conditions (e.g., soil type and moisture) *underlying the buildings* would be useful for characterizing the subsurface vapor migration route between the subsurface vapor source and the building. Sub-slab soil gas samples and indoor air samples (if background sources are removed or accounted for), in concert with other lines of evidence, can provide a strong line of evidence regarding whether the vapor intrusion pathway is complete.
- For an industrial building, indoor air testing while the HVAC system is not operating (see Section 6.3.3) could be useful for diagnosing vapor intrusion. On the other hand, single-family detached homes can generally be presumed susceptible to soil gas entry when heating or cooling systems are operating.

## 7.2 Weigh and Assess Concordance Among the Lines of Evidence

To the risk manager, the ideal outcome from collecting multiple lines of appropriate evidence is a concordant set of site-specific information that unambiguously supports decisions that can be made confidently. However, based upon observations at many buildings and sites, the vapor intrusion site where all available information is in agreement and is unambiguous may be the exception rather than the rule. Some lines of evidence may not be definitive (e.g., indoor air and subsurface concentrations can be greatly variable temporally and spatially). At worse, some individual lines of evidence may be inconsistent with other lines of evidence. In general, when lines of evidence are not concordant and the weight of evidence does not support a confident decision, EPA recommends re-evaluating the CSM, which may warrant adjusting the CSM to better represent the weight of the available evidence.

*For example, a building overlying contaminated shallow groundwater may have high concentrations of vapor-forming chemicals in the sub-slab soil gas samples, but lower concentrations in soil gas samples collected exterior to the building at intermediate depths. In this example, the exterior soil gas data suggest there may not be a connected vapor migration path between the groundwater source and the building that exhibits continuous attenuation along the path. Nevertheless, the data review team may conclude that vapor migration is capable of transporting hazardous vapors from the source to building(s) if the groundwater and sub-slab soil gas samples share common contaminants that are known or suspected to have been released at the site (for example, samples of both groundwater and*

---

<sup>191</sup> Because of the large uncertainties associated with measuring concentrations of volatile contaminants introduced during soil sampling, preservation, and chemical analysis, bulk soil (as opposed to soil gas) sampling and analysis is not currently recommended for estimating the potential for vapor intrusion to pose unacceptable human health risk in indoor air. In addition, there are uncertainties associated with soil partitioning calculations.

*the sub-slab soil gas contain TCE). In this circumstance, the data review team may wish to consider whether the occurrence of a higher TCE concentration in the sub-slab soil gas than in the exterior soil gas sample(s) can be explained by: (1) a previously unknown or unrecognized utility corridor or other preferential migration route that provides relatively unattenuated vapor transport between the groundwater and the building; (2) a previously unknown or unrecognized source of TCE in the vadose zone; or (3) the possibility that the exterior soil gas samples were not well located for purposes of characterizing subsurface vapor migration. This example also underscores the importance of developing an adequate CSM (e.g., identify all sources and preferential routes of subsurface vapor migration) and illustrates why EPA generally recommends that the vapor intrusion pathway not be deemed incomplete based upon any single line of evidence (EPA 2010b), such as exterior soil gas in this example.*

When lines of evidence are not concordant and the weight of evidence does not support a confident decision, it may also be appropriate to collect additional lines of evidence, possibly including additional samples, depending upon the CSM. For example:

- Appropriate site-specific testing (see Section 6.3.5) can be conducted to assess the contribution of background sources of vapor-forming chemicals, including comparisons among chemicals of their relative concentrations in indoor air, outdoor air, and soil gas. Background sources of vapor-forming chemicals may help to explain situations where the indoor air concentration is higher than can be accounted for by the subsurface vapor source or the sub-slab soil gas data.
- Diagnostic testing of indoor air (see Section 6.4.1), building condition assessments or utility surveys, or supplemental hydrogeologic characterization (see Section 6.3.2) can be used to investigate the suspected presence of preferential migration routes, such as those described in Sections 5.4 and 6.3.2. Such investigations may help to explain situations where the sub-slab or indoor air concentration appears to reflect unattenuated vapor transport from the subsurface vapor source.
- Building susceptibility to vapor intrusion can be tested (see Section 6.3.3), which may help to explain situations where the indoor air concentration is significantly lower than expected based upon the sub-slab soil gas data.
- Vapor migration in the vadose zone can be further characterized to identify impedances to vapor migration (see Section 6.3.2), appropriate semi-site specific attenuation factors can be considered (see Section 6.5.3), and appropriate modeling can be conducted (see Section 6.6) to investigate site-specific vapor attenuation. Such data and analyses may help to explain situations where the sub-slab soil gas concentration is significantly lower than expected based upon groundwater source or “near-source” soil gas concentrations and the respective medium-specific attenuation factor (Section 6.5.2 and Appendix A). In some of these situations, the vapor intrusion pathway may be impeded, or perhaps even incomplete, due to geologic, hydrologic, or microbial characteristics in the vadose zone (see Sections 6.3.2 and 7.3).

Recognizing the temporal and spatial variability of indoor air and subsurface concentrations and the potentially episodic nature of vapor intrusion at some sites (Section 2), EPA generally recommends collecting multiple rounds of sampling in the respective media from multiple locations (see Section 6.4) to reduce the chance of reaching a false-negative or false-positive

conclusion. Considerable judgment may be necessary when evaluating multiple data sets from individual sampling events to support decision-making.

In summary, EPA recommends the appropriate use and evaluation (“weighing”) of multiple lines of evidence for determining whether the vapor intrusion pathway is complete or not, whether any elevated levels of contaminants in indoor air are likely caused by subsurface vapor intrusion versus an indoor source or an ambient (outdoor) air source, whether concentrations of subsurface contaminants in indoor air may pose a health concern, and whether interim response measures to mitigate vapor intrusion are warranted.

### **7.3 Evaluate Whether the Vapor Intrusion Pathway is Complete or Incomplete**

For purposes of this Technical Guide, and as reflected in the conceptual model of vapor intrusion (see Section 2), the vapor intrusion pathway is referred to as “complete” for a specific building or collection of buildings when the following five conditions are met under current conditions:

- 1) A subsurface source of vapor-forming chemicals is present underneath or near the building(s) (see Sections 2.1, 5.3, 6.2.1, and 6.3.1);
- 2) Vapors form and have a route along which to migrate (be transported) toward the building(s) (see Sections 2.2 and 6.3.2);
- 3) The buildings are susceptible to soil gas entry, which means openings exist for the vapors to enter the building and driving ‘forces’ exist to draw the vapors from the subsurface through the openings into the building(s) (see Sections 2.3 and 6.3.3);
- 4) One or more vapor-forming chemicals comprising the subsurface vapor source(s) is (or are) present in the indoor environment (see Sections 6.3.4 and 6.4.1); and
- 5) The building is occupied by one or more individuals when the vapor-forming chemical(s) is (or are) present indoors.

Considerable scientific and professional judgment will likely be needed when weighing lines of evidence to determine whether the vapor intrusion pathway is complete or incomplete. Each of the first four conditions generally entails obtaining and weighing multiple lines of evidence, whereas the fifth condition generally can be confidently determined by direct observation. EPA recommends considering and evaluating together the various lines of evidence in determining completeness of the vapor intrusion pathway under current conditions.

As noted previously (e.g., Section 3.2), EPA recommends that risk management decisions also consider whether the vapor intrusion pathway is ‘potentially complete’ under reasonably expected future conditions. The vapor intrusion pathway is referred to as ‘potentially complete’ for a building when:

- a subsurface source of vapor-forming chemicals is present underneath or near an existing building or a building that is reasonably expected to be constructed in the future;
- vapors can form from this source(s) and have a route along which to migrate (be transported) toward the building; and



- three additional conditions are reasonably expected to all be met in the future, which may not all be met currently; i.e.,
  - the building is susceptible to soil gas entry, which means openings exist for the vapors to enter the building and driving forces exist to draw the vapors from the subsurface through the openings into the building;
  - one or more vapor-forming chemicals comprising the subsurface vapor source(s) is (or will be) present in the indoor environment (see Sections 6.3.4 and 6.4.1); and
  - the building is or will be occupied by one or more individuals when the vapor-forming chemical(s) is (or are) present indoors.

This determination also generally entails obtaining and weighing multiple lines of evidence.

A complete pathway indicates that there is an opportunity for human exposure, which warrants further analysis to determine whether there is a basis for undertaking a response action(s). Specifically, a complete exposure pathway does not necessarily mean that an unacceptable human health risk exists due to vapor intrusion. Rather, specific exposure conditions, such as the magnitude, frequency, and duration of exposures, and the contribution from background concentrations warrant examination; hence, EPA recommends additional analyses be conducted to assess and characterize human health risk to building occupants where the vapor intrusion pathway is determined to be complete (see, for example, Sections 7.4 and 6.3.5). On the other hand, human exposure, and hence human health risk, from the vapor intrusion pathway would not exist if the pathway is incomplete.

The conceptual model described in Section 2 identifies the characteristics of the vadose zone that could render the vapor intrusion pathway incomplete under current and future conditions. These individual characteristics include, but are not limited to:

- Soil layers that significantly and persistently impede vapor transport due to geologic or hydrologic conditions (e.g., fine-grained soil, soil with high moisture content) and are laterally extensive over distances that are large compared to the size of the building(s) or the extent of subsurface contamination with vapor-forming chemicals; and
- A biologically active vadose zone that can significantly and persistently attenuate soil gas concentrations due to biodegradation, in which all appropriate conditions (e.g., nutrients, moisture, and electron acceptors, such as dissolved oxygen in the case of aerobic biodegradation) are readily available over a laterally extensive area.

EPA recommends demonstrating these characteristics, when present, by collecting, evaluating, and documenting multiple lines of evidence, as identified in Section 6.3.2. In addition, EPA recommends that any determination that the vapor intrusion pathway is incomplete be supported by site-specific evidence to demonstrate that:

- The nature and extent of vapor-forming chemical contamination in the subsurface has been well characterized, as discussed in Sections 6.3.1 and 6.4. Ideally, where groundwater is the source of vapors, the plume has been shown to be stable or

shrinking to establish that the potential for vapor intrusion to pose a health concern will not increase in the future.

- The types of vapor sources and the conditions of the vadose zone and surrounding infrastructure do not present opportunities for unattenuated or enhanced transport of vapors toward and into any building (e.g., via a preferential migration route(s)), as discussed in Sections 5.4, 6.2.1, 6.3.2, and 6.5.2.

When the vapor intrusion pathway is determined to be incomplete, then vapor intrusion mitigation is not generally warranted under current conditions. EPA recommends that site managers also evaluate whether subsurface vapor sources that remain have the potential to pose a complete vapor intrusion pathway and unacceptable human health risk due to vapor intrusion in the future if site conditions were to change. For example, potentially unpredictable changes in the transitory soil characteristics (e.g., soil moisture) and soil gas concentrations may occur as a result of constructing a new building or supporting infrastructure. Either type of change could result in the potential for unacceptable human health risk due to vapor intrusion in the future.

Response actions may, therefore, be warranted to protect human health wherever and as long as subsurface vapor sources remain that have the potential to pose unacceptable human health risk in the future due to vapor intrusion. These response actions (see Section 7.7) may include institutional controls (see Section 8.6) (e.g., to record and alert parties about the presence of subsurface vapor sources and/or to inform the need for a confirmatory vapor intrusion investigation in case infrastructure or geologic conditions are modified in the future). In addition, subsurface remediation may be warranted to protect human health or the environment via other exposure pathways (e.g., groundwater discharge to surface water bodies), consistent with applicable statutes and considering EPA guidance.

#### **7.4 Conduct and Interpret Human Health Risk Assessment**

EPA generally recommends that a human health risk assessment be conducted to determine whether the potential human health risk posed to building occupants by a complete or potentially complete vapor intrusion pathway are within or exceed acceptable levels, consistent with applicable statutes<sup>192</sup> and considering EPA guidance (EPA 1991a, 2009c). The primary purpose of this risk assessment is to provide risk managers with an understanding of the actual and potential risks to human health posed by vapor intrusion under current and reasonably expected future conditions. This information may be useful in determining whether a current or potential future threat to human health exists, as described in Sections 7.4.1, 7.4.2, and 7.5.2,<sup>193</sup> which warrants response action(s), as described in Sections 7.7 and 8.

---

<sup>192</sup> In the RCRA corrective action program, any human health risk assessment would typically be conducted during the RCRA facility investigation, if a release to the environment is identified. Under the CERCLA remedial program, a human health risk assessment would typically be conducted during the remedial investigation and is generally referred to as a baseline (i.e., pre-cleanup) risk assessment.

<sup>193</sup> In appropriate circumstances (e.g., where time is of the essence to ensure protection of human health; see, for example, Section 7.5.2), a formal human health risk assessment need not be completed and documented before taking a response action, but a preliminary evaluation of human health risk using individual building data or aggregated community data is generally recommended (also see Section 7.8).

The human health risk posed to building occupants by intrusion of a given vapor-forming chemical will depend upon its toxicity, its concentration in indoor air, the amount of time the occupants spend in the building, and other variables (e.g., human life stage (e.g., child) can matter for some chemicals (e.g., those with a mutagenic mode of action for carcinogenicity)). EPA recommends that its risk assessment guidance (e.g., EPA 2009c, EPA 2003) be used to identify, develop, and combine information about these variables and characterize human health risk due to vapor intrusion from subsurface contaminant sources.

For the vapor intrusion pathway, the inhalation route is the primary means of human exposure. Therefore, the human health risk assessment uses estimates of indoor air exposure concentrations, exposure duration and frequency for building occupants, and the potential toxicity of the vapor-forming chemicals found in the subsurface (e.g., inhalation unit risk and noncancer reference concentration) to characterize risks of cancer and noncancer effects (EPA 2009c). Generally, exposure concentrations in existing buildings can be estimated using direct measurements of indoor air (see Sections 6.3.4 and 6.4.1). EPA recommends that time-integrated measurements from multiple sampling events be used to estimate exposure concentrations appropriate for the exposure (occupancy) scenario being evaluated (e.g., residential versus commercial), when the risk assessment for an existing building would support a conclusion that the human health risk is acceptable (see Section 7.4.1).<sup>194,195</sup> Generally, modeling would be used to conservatively estimate exposure concentrations under future conditions in buildings yet to be constructed in areas with subsurface contamination by vapor-forming chemicals (see Section 6.6). EPA recommends the noncancer assessment consider the potential for adverse health effects from short-duration inhalation exposures (i.e., acute, short-term, or subchronic exposure durations),<sup>196</sup> as well as longer term inhalation exposure (i.e., chronic exposure) conditions. EPA recommends that inhalation toxicity values be selected

---

<sup>194</sup> An individual sample, collected at a randomly chosen time, may under-estimate (or over-estimate) average and reasonable maximum exposure conditions. From their high-frequency, measured data, Holton et al. formulated a synthetic data set (simulating one-day-average concentrations), which they used to estimate that a single, randomly drawn, one-day sample had a forty percent chance of being less than the true mean (Holton et al. 2013b; see Table 1 therein). When the true mean was assumed to exceed the risk-based action level ("target concentration" in their parlance) by two or five times, they estimated that a single, randomly drawn, one-day sample had a twenty percent or six percent chance, respectively, of not detecting the exceedance. These data support EPA's recommendation to collect multiple rounds of indoor air sampling data to reduce the chance of reaching a false-negative conclusion (i.e., concluding exposure is at an acceptable risk level when it is not). Collecting multiple rounds of indoor air sampling can also reduce the chance of reaching a false-positive conclusion (i.e., concluding that vapor intrusion poses unacceptable human health risk when it does not), because an individual sample, collected at a randomly chosen time, may over-estimate the average and reasonable maximum exposure conditions.

<sup>195</sup> Given EPA's assigned mission to protect human health from environmental contamination and recognizing the disruption to building owners and occupants caused by indoor air sampling, risk managers may choose to pursue pre-emptive mitigation (i.e., early action) at some buildings (see Sections 3.3 and 7.8) rather than, for example, conduct multiple rounds of sampling over a few years to establish an estimate of long-term average exposure concentration and characterize temporal variability.

<sup>196</sup> The inhalation reference concentration (RfC) (expressed in units of mass concentration in air) is defined as an estimate (with uncertainty spanning perhaps an order of magnitude) of a continuous inhalation exposure to the human population (including sensitive subgroups) that is likely to be without an appreciable risk of deleterious effects during a lifetime. Reference values may be derived for acute ( $\leq 24$  hours), short-term ( $>24$  hours, up to 30 days), subchronic ( $>30$  days, up to approximately 10% of the life span), and chronic (greater than 10% of the life span) exposure durations, all of which are derived based on an assumption of continuous exposure throughout the duration specified. See [http://www.epa.gov/ncea/iris/help\\_ques.htm#whatisiris](http://www.epa.gov/ncea/iris/help_ques.htm#whatisiris)

considering OSWER's hierarchy of sources (EPA 2003) and that relevant existing guidance (e.g., EPA 2009c) be followed in situations where a desired toxicity value is not available.

When a single vapor-forming chemical is present in the subsurface and intrudes as a vapor into occupied building spaces, the noncancer human health risk can be characterized by calculating the noncancer hazard quotient (HQ) (EPA 2009c, Chapter 8). When multiple vapor-forming chemicals are present in the subsurface and intrude as vapors into occupied building spaces, the HQ estimates for each chemical are aggregated (as a simple sum, which is the Hazard Index (HI)), based upon the assumption that each chemical acts independently (i.e., there are no synergistic or antagonistic toxicity interactions among the chemicals). If the HI exceeds one, there may be concern for potential adverse non-cancer effects and risk assessors should consider segregating the chemicals by target organ or toxic effect to derive separate hazard index (HI) values for each (EPA 2009c, Chapter 8). EPA recommends that noncancer HQ and HI values be estimated for each type of exposure period identified in the conceptual site model or indicated by measurements of indoor air levels of vapor-forming chemicals (e.g., chronic, subchronic, short-term, acute), evaluating inhalation reference concentrations that "match the characterization of the exposure scenario" (EPA 2009c, Chapter 4).<sup>197</sup>

The carcinogenic risks can be characterized by calculating the excess cancer risk over a lifetime (LCR) and, if multiple vapor-forming chemicals are present, aggregating the LCR estimates for each carcinogen (as a simple sum), based upon the assumption that each chemical acts independently (EPA 2009c, Chapter 8).

A well-crafted risk characterization section (EPA 1992c, 1995ab, 2000b, 2009c) puts risk calculations into context for risk managers, so that they may effectively weigh and interpret risk assessment results and recognize key uncertainties (e.g., in the exposure and dose-response assessments and risk estimation).<sup>198</sup> Additional recommendations for promoting and increasing the utility and transparency of human health risk assessments can be found in *Framework for Human Health Risk Assessment to Inform Decision Making* (EPA-RAF, 2014).

---

<sup>197</sup> For example, when evaluating situations in which vapor concentrations in indoor air exceed the chronic reference concentration (see Section 7.4.1), and there are shorter periods of significantly higher vapor intrusion exposure, EPA recommends that noncancer risks for the shorter periods also be characterized using toxicity values appropriate for the respective period(s). On the other hand, if vapor concentrations in indoor air are consistently less than benchmarks for acceptable chronic exposure, then exposures for less-than-chronic scenarios are unlikely to pose unacceptable human health risk.

<sup>198</sup> For example, EPA recommends that the risk characterization for existing buildings describe the uncertainty in the exposure assessment arising from: (i) inherent variability of indoor air exposures over time and space; (ii) the match between the sampling data [e.g., sampling frequency (i.e., number of samples and time intervals between samples); and time period over which each sample was collected] and the exposure period represented by the selected toxicity value (e.g., chronic); and (iii) the ability to distinguish and apportion the contribution to indoor air concentrations arising from vapor intrusion versus background sources. EPA recommends that the risk characterization for future buildings describe the principal uncertainties in the exposure assessment, which may be associated with the type(s) of building use, building construction and operations (e.g., HVAC system), frequency and duration of occupancy, vapor concentrations in indoor air, or other factors.

EPA recommends that any human health risk assessment be documented; a summary in a decision document is also generally warranted.<sup>199</sup> EPA also recommends that human health risk information for individual buildings be communicated to building occupant(s) and owners. Section 9.4 provides additional information for communicating sampling results.

#### 7.4.1 Risk Management Benchmarks

EPA recommends that OSWER programs make the risk management determination to take response action consistent with their statutes and regulations and considering existing program guidance.<sup>200</sup> The carcinogenic risk and non-cancer HI values used in this determination generally are the “cumulative risks” that include all exposure pathways that a given population may consistently face.<sup>201</sup> In making such risk management determinations, EPA generally recommends reporting the HQ and HI to one significant figure.

EPA generally uses a cancer risk range of  $10^{-6}$  to  $10^{-4}$  as a “target range” within which to manage human health risk as part of site cleanup. For judging whether indoor air exposures may pose acceptable health risk based upon potential non-cancer effects, EPA generally recommends that the target HQ or HI not exceed 1.

Once a decision has been made to undertake a response action, EPA has expressed a preference for cleanups that are at the more protective end of the cancer risk range. Thus, EPA recommends using an individual lifetime cancer risk of  $10^{-6}$  as a point of departure for establishing cleanup levels based upon potential cancer effects (see Section 7.6).<sup>202</sup> The EPA risk manager may determine that a response action achieving reductions in human health risk

---

<sup>199</sup> Devices that have been found to improve comprehension and retention of textual materials include a table of contents, clear section headings, and a summary (Morgan et al. 1992). It is most helpful to provide a summary that translates the risk assessment into relatively simple language that non-expert risk managers, stakeholders, and wider audiences can understand (Lundgren and McMakin, 2013). Hazards and risks posed by vapor intrusion are more likely to be misunderstood or misinterpreted if they are not explained in simple terms.

<sup>200</sup> See, for example: *The Role of the Baseline Risk Assessment in Superfund Remedy Selection Decisions*, OSWER Directive 9355.0-30, April 22, 1991 (EPA 1991a); *Rules of Thumb for Superfund Remedy Selection*, OSWER Directive 9355.0-69, August 1997 (EPA 1997); and Advanced Notice of Proposed Rulemaking: Corrective Action for Solid Waste Management Units at Hazardous Waste Management Facilities (61 *Federal Register* 19432, May 1, 1996). So, for example, EPA cited OSWER Directive 9355.0-30 (EPA 1991a) in its *Compilation of Information Relating to Early/Interim Actions at Superfund Sites and the TCE IRIS Assessment* (EPA 2014b).

<sup>201</sup> In some site-specific situations, a population might be exposed to a substance or combination of substances through several exposure pathways (i.e., not only the vapor intrusion pathway). For example, individuals might be exposed to substance(s) from a contaminated site by consuming contaminated drinking water from a groundwater supply, as well as from vapor intrusion. Once reasonably expected exposure pathways have been identified, EPA recommends examining whether it is likely that the same individuals would consistently face the reasonable maximum exposure for each pathway or a combination of some of these pathways. Under such circumstances, the total exposure to each chemical would equal the sum of the exposures by all consistently faced pathways (EPA 1989, Section 8.3) and EPA recommends that the risk assessor clearly identify those exposure pathway combinations for which a total risk estimate or hazard index is being developed. When characterizing human health risk arising from multiple pathways and posed by a vapor-forming chemical(s) with potential adverse noncancer effects, EPA recommends that the toxicity values for each pathway “match the characterization of the exposure scenario” (EPA 2009c, Chapter 4).

<sup>202</sup> See: National Oil and Hazardous Substances Pollution Contingency Plan (55 *Federal Register* 8717); and Advanced Notice of Proposed Rulemaking: Corrective Action for Solid Waste Management Units at Hazardous Waste Management Facilities (61 *Federal Register* 19432, May 1, 1996).

within the  $10^{-6}$  to  $10^{-4}$  cancer risk range is acceptable, however, depending on site-specific conditions or remedial factors.

For establishing cleanup levels based upon potential non-cancer effects, EPA generally recommends that the target HI not exceed 1 (see Section 7.6).

#### 7.4.2 Accounting for Background Contributions

As noted previously, EPA recommends including in the human health risk assessment vapor-forming chemicals that are related to releases to the subsurface environment. Some of these vapor-forming chemicals may be present in indoor air due to 'background' sources (see Section 2.7). If data are available, EPA recommends that the contribution of 'background' to total exposure concentration(s) be distinguished in the human health risk assessment (EPA 2002e). If background vapor sources (see Glossary) are found to be primarily responsible for indoor air concentrations (see Section 6.3.5), then response actions for vapor intrusion would generally not be warranted for current conditions. In any event, EPA recommends that the risk characterization include a discussion of 'background' contributions to indoor air exposure and associated human health risk. With such information, EPA can help advise affected individuals about the environmental and public health risks they face that are within their control (e.g., indoor sources of vapor-forming chemicals in residences).<sup>203</sup> Other parties, including building owners and operators, may help with risk communication.

If 'background' contributions are unknown and such data are sought to support risk management decisions, EPA recommends that additional data be collected (see, for example, Section 6.3.5). Information on 'background' contributions of site-related, vapor-forming chemicals in indoor air is also important to risk managers because generally EPA does not clean up to concentrations below natural or anthropogenic background levels (EPA 2002e).

#### 7.4.3 Occupational Exposure Limits

Permissible exposure limits (PELs) are enforceable occupational exposure standards developed by the Occupational Safety and Health Administration (OSHA) in the U.S. Department of Labor. Most of OSHA's PELs were adopted in 1971 from then-existing secondary guidance levels, such as Threshold Limit Values (TLVs) developed by the American Conference of Governmental Industrial Hygienists (ACGIH) to protect workers from adverse effects of occupational exposure to airborne chemicals. They were intended to protect workers against catastrophic effects (such as cardiovascular, liver, kidney, and lung damage), as well as more subtle effects (such as narcosis, central liver system damage, and sensory irritation).

PELs (and TLVs), however, are not intended to protect sensitive workers, may not incorporate the most recent toxicological data, and may differ from EPA derivations of toxicity values with respect to weight-of-evidence considerations and use of uncertainty factors. For these and other

---

<sup>203</sup> In cases where 'background' contamination (e.g., due to indoor use of a consumer product or household chemical in a residence) may pose a human health risk, but its remediation is beyond the authority of the applicable statute, risk communication to the public may be most effective when coordinated with public health agencies (EPA 2002e).

reasons,<sup>204</sup> EPA does not recommend using OSHA's PELs (or TLVs) for purposes of assessing human health risk posed to workers (EPA 1991c, Appendix C) by the vapor intrusion pathway or supporting final "no-further-action" determinations for vapor intrusion arising in nonresidential buildings. Rather, EPA's recommendations for assessing human health risk posed by vapor intrusion are set forth herein in Sections 7.4.1 and 7.4.2.

## 7.5 Concentration Levels Indicating Potential Need for Prompt Response Action

In some circumstances, human health risk arises from vapor intrusion, which warrants prompt response action. This Section provides some recommendations for identifying such circumstances.

### 7.5.1 Potential Explosion Hazards

EPA recommends using the chemical-specific LELs<sup>205</sup> to identify potential explosion hazards (e.g., for methane and other petroleum hydrocarbons). Whenever building-specific data (such as results from sub-slab soil gas samples and crawl space samples for any building type, indoor air samples from sheds or pump houses, or gas samples from confined or semi-confined spaces (e.g., sewers)) exceed one-tenth (10%) of the LEL for any chemical, a hazard is indicated that generally warrants prompt action.<sup>206,207</sup> EPA recommends to building owners and occupants the evacuation of buildings with potential explosion and fire hazards, along with immediate notification to the local fire department about the threat. Construction and operation of engineered systems that can reduce or eliminate intrusion of explosive vapors into existing buildings or unoccupied structures may also warrant consideration to reduce the potential for future explosion hazards.

### 7.5.2 Considering Short-term and Acute Exposures

EPA may identify health-protective concentration levels for vapor-forming chemicals based upon potential noncancer health effects that can be posed by air exposures over short-term or acute exposure durations, considering EPA guidance for human health risk assessment (e.g., EPA

---

<sup>204</sup> OSHA's website (May 2015) currently states: "OSHA recognizes that many of its permissible exposure limits (PELs) are outdated and inadequate for ensuring protection of worker health. Most of OSHA's PELs were issued shortly after adoption of the Occupational Safety and Health (OSH) Act in 1970, and have not been updated since that time. Since 1970, OSHA promulgated ... new PELs for 16 agents, and standards without PELs for 13 carcinogens. Industrial experience, new developments in technology, and scientific data clearly indicate that in many instances these adopted limits are [also] not sufficiently protective of worker health. This has been demonstrated by the reduction in allowable exposure limits recommended by many technical, professional, industrial, and government organizations, both inside and outside the United States." [On-line source: <https://www.osha.gov/dsg/annotated-pels/>] On October 10, 2014, OSHA issued a Chemical Management Request for Information (79 FR 61384), in which it acknowledges many of its PELs are not sufficiently protective and seeks comment on strategies to address this problem; available on-line at: [https://www.osha.gov/FedReg\\_oshapdf/FED20141010.pdf](https://www.osha.gov/FedReg_oshapdf/FED20141010.pdf)

<sup>205</sup> The Vapor Intrusion Screening Level Calculator (EPA 2015a) provides LELs for vapor-forming chemicals to facilitate identification of potential explosion hazards.

<sup>206</sup> NIOSH has designated such concentrations as immediately dangerous to life or health (IDLH).

<sup>207</sup> Although the building-specific data may vary temporally, any short-term exceedance of one-tenth of the LEL indicates vapor concentrations that, given an ignition source and available oxygen, may be capable of causing an explosion.

2009c) and using sources of toxicity information considering OSWER's hierarchy (EPA 2003). For example, subchronic reference concentrations, developed by the EPA Office of Research and Development/National Center for Environmental Assessment/ Superfund Health Risk Technical Support Center (STSC), are currently available for some vapor-forming chemicals as Provisional Peer Reviewed Toxicity Values (PPRTVs), which are designated as a Tier 2 source of toxicity values by OSWER (EPA 2003). Acute and intermediate Minimal Risk Levels (MRLs)<sup>208</sup> adopted by the Agency for Toxic Substances and Disease Registry (ATSDR) are currently available for some vapor-forming chemicals and are designated as a Tier 3 source of toxicity values by OSWER (EPA 2003). PPRTVs and ATSDR MRLs are peer reviewed and are publicly available (see, <http://hhpprtv.oml.gov/> and <http://www.atsdr.cdc.gov/mrls.html>).

Historically, toxicity values for short-term or acute exposure durations have not been derived or published in EPA's IRIS, which otherwise is EPA's preferred source of toxicity values (EPA 2003). EPA, under its authority, will work to develop expanded science policy direction to address short-term exposures and develop and identify appropriate toxicity values for additional chemicals for consideration for vapor intrusion assessment and related OSWER regulatory frameworks. EPA recommends that relevant existing guidance (e.g., EPA 2009c) be followed in situations where a desired toxicity value is not available, using sources of toxicity information considering OSWER's hierarchy (EPA 2003).

Although the indoor air concentrations may vary temporally, an appropriate exposure concentration estimate (e.g., time-integrated or time-averaged indoor air concentration measurement in an occupied space – see Section 6.4.1) that exceeds the health-protective concentration levels for acute or short-term exposure (i.e., generally considered to be a hazard quotient (HQ) greater than one for an acute or short-term exposure period)<sup>209</sup> indicates vapor concentrations that are generally considered to pose an unacceptable human health risk.<sup>210</sup>

As noted in Section 7.4 of this Technical Guide, a well-crafted risk characterization section (EPA 1992c, 1995ab, 2000b, 2009c) puts risk calculations into context for risk managers, so that they may effectively weigh and interpret risk assessment results and recognize key uncertainties (e.g., in the exposure and dose-response assessments and risk estimation). Uncertainties include the derivation of an RfC, which is defined as "...an estimate (with uncertainty spanning perhaps an order of magnitude)..." (See [http://www.epa.gov/ncea/iris/help\\_ques.htm#whatiris](http://www.epa.gov/ncea/iris/help_ques.htm#whatiris)). Sections 3.3 and 7.7 identify other EPA-recommended considerations for risk managers.

When indoor air concentrations in an occupied space exceed health-protective concentration levels for short-term or acute inhalation exposures arising from a complete vapor intrusion

---

<sup>208</sup> Minimal Risk Levels (MRLs) published by ATSDR are estimates of the daily human exposure to a hazardous substance that is likely to be without appreciable risk of adverse non-cancer health effects over a specified duration of exposure. The ATSDR MRLs are peer reviewed and are publicly available (<http://www.atsdr.cdc.gov/mrls.html>).

<sup>209</sup> See Glossary for definitions of "acute" and "short-term" exposure durations.

<sup>210</sup> See, for example: *The Role of the Baseline Risk Assessment in Superfund Remedy Selection Decisions*, OSWER Directive 9355.0-30, April 22, 1991 (EPA 1991a); and *Rules of Thumb for Superfund Remedy Selection*, OSWER Directive 9355.0-69, August 1997 (EPA 1997). In addition, the NCP states "For systemic toxicants, acceptable exposure levels shall represent concentration levels to which the human population, including sensitive subgroups, may be exposed without adverse effect during a lifetime or part of a lifetime, incorporating an adequate margin of safety" [40 CFR 300.430(e)(2)(i)(1)].



pathway, ventilation, indoor air treatment, temporary relocation, and other response actions may be implemented to reduce or avoid these threats promptly (see Section 8.2.1). Construction and operation of engineered systems that can reduce or eliminate vapor intrusion into existing buildings (see Section 8.2) may also warrant consideration after urgent threats to human health have been addressed.

## 7.6 Risk-based Cleanup Levels

When response action is determined to be warranted to reduce or eliminate indoor air exposures from vapor intrusion (see Sections 7.4 and 7.5), EPA recommends that cleanup levels be established and documented consistent with statutes and regulations and considering guidance for the respective OSWER program.<sup>211</sup> These cleanup levels would be used to evaluate when building mitigation measures, subsurface remediation, and associated monitoring can be terminated and to assess cleanup progress in the meantime (see Section 8.7).

Candidate risk-based cleanup levels can be calculated using information from the risk assessment (Section 7.4). Results of the human health risk assessment indicate, for example, which site-related vapor-forming chemicals warrant building mitigation and subsurface remediation. The exposure factors and toxicity values used in the human health risk assessment can be used to calculate chemical-specific cleanup levels, considering EPA risk assessment methods (e.g., EPA 2009c, EPA 2003). Candidate cleanup levels are usually developed for potential cancer and non-cancer effects. The lower (or lowest if there are multiple potential non-cancer effects) of the candidate values, based upon cancer risk and non-cancer HQ/HI targets, is generally recommended for selection as the cleanup level (EPA 1991c, Section 3.4 therein).<sup>212</sup> The VISL Calculator (<http://www.epa.gov/oswer/vaporintrusion/guidance.html>) can be used to support these calculations, including input of alternative attenuation factor(s) based upon site- or building-specific information.

Calculating candidate cleanup levels based upon potential cancer effects entails selecting a target cancer risk. As noted above (Section 7.4.1), once a decision has been made to undertake a response action, EPA has expressed a preference for cleanups achieving the lower end of the cancer risk range (i.e.,  $10^{-6}$ ) (EPA 1991a). Response actions achieving reductions in human health risk anywhere within the cancer risk range may be deemed acceptable by the EPA risk manager, however.

To protect human health from potential noncancer effects, EPA generally recommends using a target value of one for the non-cancer HQ (if there is a single vapor-forming chemical of health concern for vapor intrusion) or for the non-cancer HI (if there are multiple vapor-forming chemicals of health concern for vapor intrusion acting by a common effect).

---

<sup>211</sup> See, for example: *RCRA Corrective Action Plan (Final)*, OSWER Directive 9902.3-2A (EPA 1994); and *A Guide to Preparing Superfund Proposed Plans, Records of Decision, and Other Remedy Selection Decision Documents*, OSWER Directive 9200.1-23P (EPA 1999b).

<sup>212</sup> An exception arises when 'background' sources pose elevated exposures, because generally EPA does not clean up to concentrations below natural or anthropogenic background levels (EPA 2002e).

Cleanup levels for indoor air can be readily calculated, as described above, without additional assumptions or modeling about vapor intrusion processes. On the other hand, cleanup levels for groundwater and/or soil gas in the vadose zone will entail developing a medium-specific vapor attenuation factor, which EPA recommends be conservatively estimated based upon site-specific information. The cleanup level for soil gas can be calculated by dividing the chemical-specific indoor air cleanup level by the site-specific soil gas vapor attenuation factor. The cleanup level for groundwater can be calculated by dividing the chemical-specific indoor air cleanup level by the site-specific vapor attenuation factor for groundwater vapors and assuming equilibrium between the aqueous and vapor phases at the groundwater table. EPA recommends that site-specific attenuation factors intended to be protective of chronic exposure conditions: be conservatively estimated when based upon mathematical models; and be based upon multiple measurements of indoor air concentration in different seasons, which have negligible influences from 'background' sources, when based upon site-specific measurements.

EPA recommends that cleanup levels be documented with at most two significant figures, even though some of the input values may carry additional significant figures (EPA 1991b, see page 19).

## 7.7 Options for Response Action

When response action is determined to be warranted to reduce or eliminate indoor air exposures from vapor intrusion (see Sections 7.4 and 7.5), EPA recommends that OSWER programs select, recommend, and document response action(s) consistent with statutes and regulations and considering their existing program guidance.<sup>213</sup>

The selection of a health-protective interim response action(s) for existing buildings will generally depend on site-specific considerations, which can include: nature of subsurface vapor source (e.g., groundwater, vadose zone soils, sewer lines), magnitude of the exposure above cleanup levels; the severity of the potential adverse health effects or health hazard; building features and conditions (e.g., construction; heating, ventilation, and air conditioning equipment); climate and season (which influence the feasibility of ventilation, for example); the quality of ambient air in the vicinity; and the feasibility of implementing a given option quickly.<sup>214</sup> In general, EPA recommends that response actions limit the amount of time individuals are exposed to concentrations that correspond to unacceptable human health risk, as described in Sections 7.4 and 7.5.

---

<sup>213</sup> See, for example: *RCRA Corrective Action Plan (Final)*, OSWER Directive 9902.3-2A (EPA 1994); and *A Guide to Preparing Superfund Proposed Plans, Records of Decision, and Other Remedy Selection Decision Documents*, OSWER Directive 9200.1-23P (EPA 1999b).

<sup>214</sup> Most response actions cannot be implemented immediately upon determining that a response is warranted. For example, engineered exposure controls ordinarily entail from two to four weeks of lead time (at a minimum) for planning, design, any permit acquisition, material acquisition and construction. In many circumstances, ventilation measures to reduce exposure can be implemented more quickly, but local climate or air quality may render this option less attractive during some seasons.

**TABLE 7-1**  
**MATRIX OF OPTIONS TO RESPOND TO HUMAN HEALTH RISK**  
**POSED BY THE VAPOR INTRUSION PATHWAY**

Option for Response Action	Applicability of Response Action for Common Sources of Sub-surface Vapors		
	Groundwater	Vadose Zone Soil	Sewer & Drain Lines
<b>Remediation of Source*</b>			
Removal of contaminated soil via excavation	•	•	•
Treatment of contaminated soil <i>in situ</i>	#	•	
Treatment of contaminated groundwater <i>in situ</i>	#	•	
Removal of contaminated groundwater (e.g., pump-and-treat)	•		
Decontaminating and/or rehabilitating sewer and drain lines	•		•
<b>Interim Measures to Reduce or Eliminate Vapor Intrusion*</b>			
Subslab de-pressurization and ventilation systems	•	•	•
Sealing major openings for soil gas entry, where known and identified <sup>+</sup>	•	•	
Building over-pressurization	•	•	
Installing, repairing, or maintaining vapor traps			•
<b>Interim Measures to Reduce or Avoid Exposure to Vapors</b>			
Notification to local fire department about potential explosion hazards <sup>+</sup>	•	•	•
Notification and risk communication to building occupants and owners, including institutional controls (e.g., deed notices)	•	•	•
Increasing building ventilation*	•	•	•
Treating indoor air*	•	•	•
Temporary relocation <sup>+</sup>	•	•	•
<b>Monitoring Indoor Air to Characterize Human Exposure</b>	•	•	•

KEY: • designates potentially appropriate response action for indicated vapor source

FOOTNOTES:

- \* includes: associated institutional controls to maintain operations and provide public notification of residual contamination; and associated monitoring to assess effectiveness and protectiveness of the response action
- # remediation of soil may also be warranted for purposes of protecting groundwater from further contamination, even if contaminated soil in the vadose zone is not a source for vapor intrusion directly (e.g., due to the absence of an existing building near the contaminated soil)
- + response option primarily applies to existing buildings

Table 7-1 presents an overview of key candidate response options for the vapor intrusion pathway, which are discussed further in Section 8. Response actions that may be recommended for and implemented in existing buildings include:

- Interim measures that can be implemented relatively quickly (see Section 8.2.1), if prompt action is warranted to reduce or eliminate exposures to vapor-forming chemicals (see Sections 5.2 and 7.5.2) or to mitigate explosion hazards (see Section 7.5.1);
- Engineered exposure controls (see Section 8.2.2) with associated monitoring and institutional controls (see Section 8.6), as an interim (but potentially long-term) measure to reduce or eliminate vapor intrusion into buildings; and
- Remediation of the subsurface vapor source (see Section 8.1) with associated monitoring and institutional controls (see Section 8.6).

Response actions that may be warranted in buildings that may be constructed in the future include:

- Remediation of the subsurface vapor source (see Section 8.1) with associated monitoring and institutional controls (see Section 8.6); and
- Institutional controls (see Section 8.6) to inform the need for building mitigation (see Section 8.2.2) and/or a confirmatory vapor intrusion investigation before the building is occupied, in case the building is to be or may be constructed before subsurface vapor sources are remediated to cleanup levels.

Indoor air monitoring has frequently been selected as a response action in circumstances where subsurface vapor sources are present and the vapor intrusion pathway has not been shown to be incomplete. Indoor air monitoring may be deemed warranted, for example:

- To better characterize spatial or temporal variability;
- To address uncertainty in the characterization of the vapor intrusion pathway when subsurface vapor sources have the potential to pose a health concern in overlying or nearby buildings (e.g., incomplete pathway characterization, concern about the potential for changes in building conditions, discordant lines of evidence); or
- For other site-specific or situation-specific reasons.

EPA generally prefers to obtain building access and undertake response actions through consent and cooperation from building owners, tenants, and other stakeholders (see Section 1.2).

## 7.8 Pre-emptive Mitigation/Early Action

It may be appropriate to implement mitigation of the vapor intrusion pathway as an early action, even though all pertinent lines of evidence have not yet been completely developed to characterize the vapor intrusion pathway for the subject building(s), when sufficient site-specific data indicate that vapor intrusion: (1) is occurring or may occur due to subsurface contamination that is being addressed by federal statutes, regulations, or guidance for environmental protection; and (2) is posing or may pose a health concern to occupants of an existing

building(s). Likewise, it may be appropriate and cost-effective to design, install, operate, and monitor mitigation systems (including passive barrier systems) in newly constructed buildings (or buildings planned for future construction) that are located in areas of vapor-forming subsurface contamination, rather than allow vapor intrusion (if any) to occur and address vapor intrusion after the fact. As described in Section 3.3, preemptive mitigation/early action is the term used to describe both situations.

Preemptive mitigation (PEM) is recognized as an early action that is intended to ensure protectiveness of human health. In this context and as described further in Section 8.2, mitigation refers to methods that seek to:

- Prevent or reduce vapor entry into a building.
- Reduce or eliminate vapors that have entered a building.

Note that the selection and implementation of PEM, when it occurs, is not necessarily intended to pre-judge final decisions about remediation of subsurface vapor sources; however, EPA generally recommends that decision-making about PEM include a consideration of the O&M and monitoring obligations. In addition, EPA recommends that the selection of PEM be based upon data and information in the administrative record and be documented in the administrative record, consistent with statutes and regulations and considering EPA guidance for the respective land restoration program (e.g., CERCLA, RCRA corrective action, brownfields, etc.), in order to provide an adequate basis for actions undertaken.

### 7.8.1 Rationale

In ensuring protectiveness of human health, PEM generally may be an appropriate approach to consider for buildings with potential vapor intrusion for a number of reasons, including:

- Building mitigation typically is an effective means of protecting human health and is cost effective for many buildings.
- The potential exposure scenario (e.g., inhalation of potentially toxic vapors) cannot generally be readily avoided by building occupants.
- Involuntary and unavoidable exposures and hazards are generally sources of anxiety and concern for affected building occupants and the general public, particularly when they occur in homes and in the workplace.
- Comprehensive subsurface characterization and investigations of vapor intrusion (to conclusively characterize unacceptable, but variable, levels of vapor-forming chemicals in soil, groundwater, and indoor air, as described in Section 6) can entail prolonged study periods, during which building occupants may be exposed and owners and environmental stewardship groups may remain anxious and concerned about potential indoor air exposures to subsurface vapors in the absence of mitigation.
- Conventional vapor intrusion investigations in and of themselves can be disruptive, particularly when indoor access is sought to acquire interior samples and assess interior building conditions.

- Mitigation can typically be implemented relatively quickly, while subsurface contamination is being more fully delineated or remediated.
- EPA's experience with residential communities suggests that many affected residents seek and prefer that mitigation systems be installed when vapor intrusion is suspected.
- Mitigation can be a cost-effective approach to help ensure protectiveness of human health during ongoing vapor intrusion investigations to acquire multiple lines of evidence and characterize spatial and temporal variability in subsurface and indoor air concentrations, as well as while subsurface remediation is being planned and conducted to reduce or eliminate subsurface vapor sources.

In summary, PEM, based on limited but credible subsurface and building data, can be an appropriate approach to begin to implement response actions quickly and ensure protectiveness of current building occupants. In such circumstances, resources can be used appropriately to focus first on mitigation of buildings and subsurface remediation, rather than site and building characterization efforts, which may be prolonged. Although PEM may be an effective tool to reduce the human exposure and human health risk, building mitigation is not generally intended to address the subsurface vapor source; as such, EPA recommends that it typically be used in conjunction with remediation of the subsurface source of vapor-forming chemicals (e.g., source removal or treatment), as discussed in Section 8.1.

### 7.8.2 General Decision Framework

To consider PEM, EPA recommends that reliable data supporting a preliminary analysis, as described in Section 5.0, and risk-based screening, as described in Section 6.5, be obtained and documented in the administrative record. In appropriate circumstances (e.g., where time is of the essence to ensure protection of human health; see, for example, Section 7.5.2), a formal human health risk assessment need not be conducted and documented before selecting PEM, but a preliminary evaluation of human health risk using individual building data or aggregated community data is generally recommended. If there are insufficient data to perform a preliminary risk analysis, but subsurface vapor sources are known to be present near buildings (see Section 5.3), EPA recommends that an appropriate vapor intrusion investigation (see Section 6) be conducted to obtain sufficient data.

EPA generally recommends that the decision to undertake building mitigation be supported by appropriate lines of site- or building-specific evidence (e.g., characterization of subsurface vapor source(s) strength and proximity to building(s); building conditions) that demonstrate that vapor intrusion has the potential to pose an unacceptable human health risk. Sections 5, 6, and 7 herein provide information about the types of evidence obtained and relied upon in assessing vapor intrusion potential and the types of analyses that can support determinations of whether the vapor intrusion pathway is complete for a specific building or collection of buildings and poses or has the potential to pose a health concern to building occupants. This information is equally pertinent for supporting final remediation and mitigation decisions and for supporting PEM consistent with applicable statutes and regulations. The premise of PEM, however, is to protect human health first without necessarily waiting to collect all lines of pertinent evidence or multiple rounds of sampling data.

Certain types of subsurface conditions may have greater potential to facilitate vapor intrusion when subsurface sources of vapors are present. These conditions include, but are not limited to:

- Shallow aquifers (for example, five feet or less from the building foundation to the seasonal high water table).
- High-permeability (e.g., gravelly) vadose zone soils that are fairly dry, which are favorable to upward migration of gases.
- Preferential migration routes, such as fractured sediments or bedrock, buried streambeds, subsurface drains, and utility conduits, as they can facilitate vertical or lateral migration of vapor with limited attenuation of chemical concentrations.

Under these conditions, it may be easier to determine that PEM may be warranted if a structure is located near a subsurface vapor source that has the potential to pose an unacceptable human health risk. Other factors to consider include the following:

- Susceptibility to soil gas entry. Some buildings have greater potential for vapor intrusion (i.e., are more susceptible to soil gas entry; see Section 2.3) than others. For example, buildings with deteriorating basements or dirt floors generally provide poor barriers to vapor (soil gas) entry. Buildings with sumps or other openings to the subsurface that can facilitate soil gas entry are also more susceptible to vapor intrusion.
- Actions undertaken or planned to address the subsurface source of vapors. For example, if the source of vapors (e.g., contaminated soil in the vadose zone) is being removed (e.g., excavation of contaminated soil or soil vapor extraction underneath the building) or is to be removed within a time frame that is protective for any potential current or near-term exposures in the overlying or nearby building, then PEM may not be warranted.

### 7.8.3 Some General Scenarios Where Pre-emptive Mitigation May be Warranted

Three general scenarios where PEM may be warranted are summarized below. The first two scenarios address situations where building(s) currently exist, while the third scenario addresses a situation where building(s) may be constructed in the future.

Site with High Potential to Facilitate Vapor Intrusion. In this scenario, indoor air concentration data have not been collected, but other lines of evidence support a conclusion that the vapor intrusion pathway is likely complete and may pose an unacceptable human health risk. Figure 7-1 shows a hypothetical residential area located near a shopping center that contains an active dry-cleaning facility. In this hypothetical example, a sufficient number of appropriately screened monitoring wells have been installed throughout the neighborhood to characterize a historical groundwater plume emanating from the dry cleaner that has migrated under eight homes and continues to migrate. Groundwater is encountered at approximately five feet below ground surface, and site geology consists of dry gravel and sands. “Near-source” soil gas samples have also been collected from several locations throughout the neighborhood and found to corroborate a high-strength vapor source near the buildings. All homes have crawl spaces with dirt floors. In this hypothetical example, PEM may be warranted for the eight buildings located above, near, or downgradient of the groundwater plume, based on the groundwater concentration and soil gas data available (i.e., PCE concentrations significantly exceeding

screening levels in this example),<sup>215</sup> and the likelihood that the proximity of the groundwater table, characteristics of the vadose zone, and building conditions will collectively facilitate vapor migration and intrusion.

Note that if a groundwater restoration system is constructed and operated and plume migration is thereby controlled, additional buildings downgradient of the plume may not warrant PEM in the future. In the meantime, an IC may be appropriate for the undeveloped parcel hydraulically down-gradient of the current leading edge of the plume.

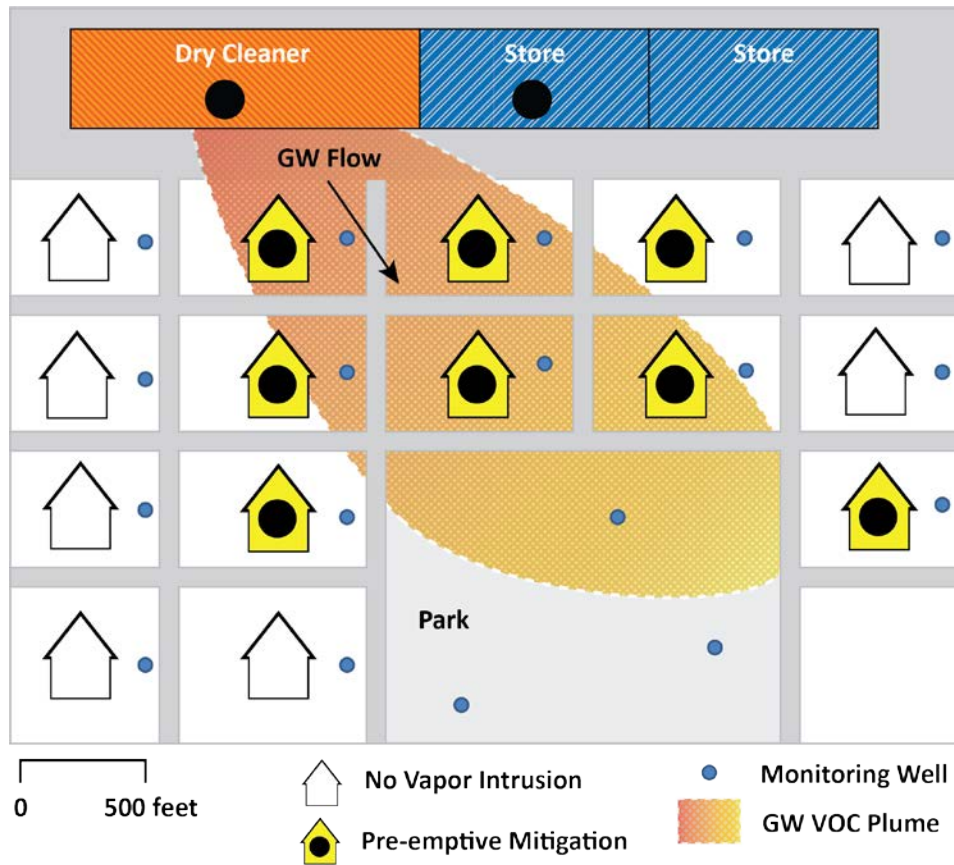
Site with Indoor Air Data for Some Buildings but Not for All Buildings. Depending on individual owners and occupants in the affected community, it may be difficult to obtain adequate data for all buildings within a specified area. Challenges include gaining timely access into each building and other practical considerations. In such circumstances, it may be appropriate to characterize a limited number of buildings under a reasonable maximum vapor intrusion condition,<sup>216</sup> by collecting and weighing multiple lines of evidence, and then extrapolating those findings to similar buildings nearby. The following hypothetical scenario describes one such situation, which is represented in Figure 7-2. In this hypothetical example, a sufficient number of appropriately screened monitoring wells have been installed throughout the neighborhood to characterize a historical groundwater plume. “Near-source” soil gas samples have also been collected from several locations throughout the neighborhood and found to corroborate the measured groundwater concentrations. Indoor air has been sampled and analyzed for a few homes and found to exhibit concentrations that pose an unacceptable human health risk. In this scenario, the assumption can be made that buildings with similar construction and built about the same time may have similar susceptibility to soil gas entry. As a result, it may be determined to use a PEM approach to offer mitigation systems to all buildings within a specified area of subsurface contamination.

---

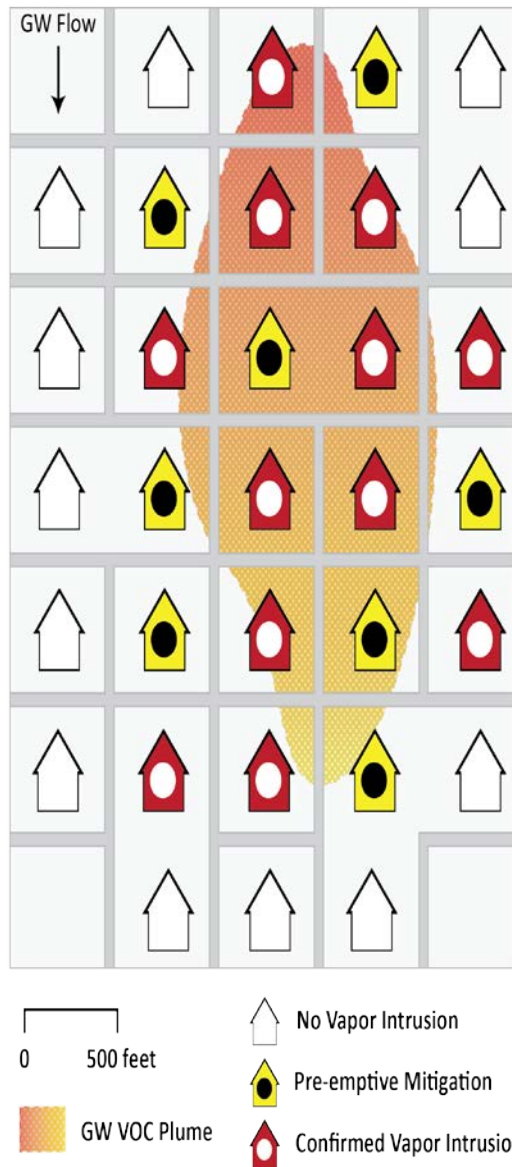
<sup>215</sup> Several site-specific factors render inappropriate the use of the recommended attenuation factors and groundwater and soil gas VISLs for purposes of identifying sites or buildings unlikely to pose a health concern through the vapor intrusion pathway, as discussed in Section 6.5.2. Nevertheless, response actions for vapor intrusion can be supported when the groundwater and soil gas VISLs are exceeded for samples from a building or site where these specific factors are present.

<sup>216</sup> EPA recommends basing decisions about whether to undertake response action for vapor intrusion (i.e., a component of risk management) on a consideration of a reasonable maximum exposure (e.g., EPA 1989, 1991a), which is intended to be a semi-quantitative phrase, referring to the lower portion of the high end of the exposure distribution (see Glossary).





**Figure 7-1 Sample Depiction of Subsurface Vapor Source and Data to Support Pre-emptive Mitigation/Early Action for Multiple Buildings, Each with Limited Data**



**Figure 7-2 Sample Depiction of Subsurface Vapor Source and Data to Support Pre-emptive Mitigation/Early Action for Multiple Buildings, Some with Only Limited or No Data**

**Future Construction and Development.** If current data (e.g., “near-source” soil gas) indicate that there is potential for unacceptable human health risk arising from vapor intrusion in an area where a building(s) is expected to be constructed in the future, EPA recommends that the remediation decision document record the known facts and data analyses and clearly state that vapor intrusion mitigation or site re-evaluation may be needed when the property is developed or occupied. EPA generally recommends appropriate ICs to ensure enforcement of such remediation decisions.<sup>217</sup>

Prior site use (see Section 5) can be particularly relevant where residential development is planned or occurring on property formerly used for commercial or industrial purposes. In these situations, it is not uncommon for residual NAPLs or shallow plumes to remain. Under this circumstance, PEM may be warranted for new construction as a precautionary measure without direct evidence of a vapor intrusion pathway. Incorporating mitigation systems into newly constructed buildings is generally easier to implement and incurs lower cost when compared with retrofitting existing structures.

On the other hand, if response actions to treat or remove the subsurface vapor source(s) are being conducted or will be conducted before a building is constructed and occupied, then building mitigation for the vapor intrusion pathway may not be warranted in the future.

#### 7.8.4 Additional Considerations

EPA recommends that the following factors also be considered in evaluating PEM and determining whether to implement it.

**Weighing Relative Costs of Characterization versus Engineered Exposure Controls.** EPA recommends that cost not be the primary criterion for deciding whether or how to mitigate vapor intrusion because protection of human health could be compromised. On the other hand, cost effectiveness is addressed by CERCLA and the NCP and can be an important consideration when evaluating response alternatives. Cost can be a factor in deciding when and whether to pursue PEM, in relation to continuing to investigate and assess actual or potential vapor intrusion, and in ensuring effective human health protection through installing and operating a vapor intrusion mitigation system. At PRP-lead sites, for example, PEM may be viewed favorably where the costs associated with a complete site characterization or continued monitoring are estimated to easily exceed the cost of installing a mitigation system (and associated system monitoring). The number of buildings that would need to be characterized, or the order of priority, may be a factor in considering whether to implement PEM.

**Institutional Controls.** For existing vapor intrusion mitigation systems, ICs may be warranted to ensure that the system is operated, maintained, and monitored. Maintenance and monitoring of the mitigation system, which are discussed in Sections 8.3 and 8.4 of this document, are generally appropriate to ensure that the system is performing as intended. In addition, ICs may facilitate access to property to conduct routine maintenance and monitoring activities, although

---

<sup>217</sup> At undeveloped sites, or at sites where land use may change in the future, ICs may be important to ensure that the vapor intrusion pathway is effectively addressed in the future. ICs at undeveloped sites could include mechanisms to inform the need for PEM in new buildings. Selecting and implementing PEM for new buildings avoids some of the difficulties associated with attempting to predict the potential for vapor intrusion prior to building construction.

separate access agreements also warrant consideration. Additional information regarding ICs is provided in Section 8.6 of this document.

Community Input and Preferences. Community acceptance of early action may vary widely, depending on the human health risk to building occupants and past experiences at the site, including interaction with site stakeholders and regulators and perceptions of the site. Some owners and occupants may view PEM as a precautionary measure and be willing to have mitigation systems installed; some may even request them before characterization is completed. On the other hand, some home owners may not agree to have a mitigation system installed unless the pathway is demonstrated to be complete.

Others may be reluctant to install mitigation systems because of the operation costs or the inconvenience associated with the installation and subsequent monitoring. Although some owners may view mitigation systems as an advantage when they sell a property, others may be concerned with the possible negative effect on property values.

Issues and concerns about equity and fairness can also arise when some homes within a neighborhood receive mitigation systems and others do not. In some situations, it may be easier to persuade property owners to install vapor intrusion mitigation systems if the entire street, block, or neighborhood is found to warrant early action.

Public meetings and one-on-one meetings provide opportunities to discuss PEM with affected property owners and building occupants and obtain information and input. Section 9.0 of this document provides additional information about community involvement and engagement.

#### Refined Conceptual Site Model

Decisions to undertake pre-emptive mitigation may warrant re-evaluation as additional monitoring and/or site and/or building characterization data become available and are evaluated in the context of the conceptual site model. If and when such data shift the weight of evidence towards a conclusion that the vapor intrusion pathway is incomplete or otherwise does not pose unacceptable health risk, then EPA recommends re-considering whether continued operation, maintenance, and monitoring of the interim response action (Section 8.2) is warranted.

## 8.0 BUILDING MITIGATION AND SUBSURFACE REMEDIATION

This section summarizes information and recommendations on potential response options to mitigate and manage vapor intrusion. It is organized as follows:

- Section 8.1 summarizes the role of subsurface remediation in mitigating vapor intrusion.
- Section 8.2 provides an overview of engineered exposure controls (i.e., building mitigation technologies) for existing and new buildings.
- Sections 8.3 and 8.4 summarize information about operating and monitoring building mitigation systems, respectively.
- Section 8.5 summarizes information about documenting building mitigation systems.
- Section 8.6 describes and provides information about institutional controls (ICs).
- Section 8.7 provides information about exit strategies (e.g., termination of: subsurface remediation for vapor source control; building mitigation system operation; and associated ICs).

Sections 5.2, 7, and 9 discuss potential bases for deciding to implement response options for vapor intrusion. Sections 3.3 and 7.7 introduced some of the response options and policies discussed in the remainder of this Section regarding components and development of cleanup plans.

### 8.1 Subsurface Remediation for Vapor Source Control

The preferred long-term response to the intrusion of vapors into buildings is to eliminate or substantially reduce the level of contamination in the subsurface vapor source (e.g., groundwater, subsurface soil, sewer lines) by vapor-forming chemicals to acceptable-risk levels, thereby achieving a permanent remedy. Remediation of the groundwater plume or a source of vapor-forming chemicals in the vadose zone will eventually eliminate potential exposure pathways and can include the following actions, among others:

- Removal of contaminated soil via excavation;
- Removal of contaminated groundwater with pump-and-treat approaches;
- Decontaminating and/or rehabilitating sewer lines that harbor vapor-forming chemicals; and
- Treatment of contaminated soil and groundwater *in situ*, using technologies such as soil vapor extraction, multiphase extraction, and bioremediation, or natural attenuation.

Because there is a substantial body of EPA and other guidance on selection, design, construction, and operation of technologies for remediation of subsurface vapor sources (e.g., EPA 1993b, 2006c; NRC 2004), these topics are not discussed further here.

When monitoring to assess the performance and effectiveness of remediation technologies for subsurface vapors, EPA recommends employing the methods, approaches, and recommendations described in Sections 5.4, 6.2, 6.4 and 7.0 of this Technical Guide.

ICs may be necessary to help ensure the continued integrity of the cleanup. In some cases, therefore, ICs such as zoning or deed restrictions, may accompany implementation of vapor source remediation methods. Section 8.6 provides information about ICs and their application to the vapor intrusion pathway.

## 8.2 Building Mitigation for Vapor Intrusion

In cases where subsurface vapor sources cannot be remediated quickly, it may be appropriate to also undertake (interim) measures in individual occupied buildings (i.e., building mitigation for vapor intrusion) to reduce threats to human health more quickly. EPA recommends that building mitigation for vapor intrusion be regarded as an interim action that can provide effective human health protection, which may become part of a final cleanup plan. Mitigation of vapor intrusion in specific buildings generally is not a substitute for remediation of subsurface vapor sources. Thus, EPA recommends that building mitigation generally be conducted in conjunction with vapor source remediation where at all possible.

The purpose of this section is to provide an overview of vapor intrusion mitigation for new and existing buildings where response action is determined to be warranted. Section 8.2.1 summarizes response options that generally can be implemented relatively quickly to reduce indoor air concentrations. Section 8.2.2 identifies and summarizes the most commonly implemented engineered control methods for reducing vapor intrusion into existing buildings. Section 8.2.3 identifies and describes some approaches and considerations for addressing vapor intrusion for new buildings. Additional detailed information about technologies for reducing vapor intrusion into buildings and their selection, design, operation, and monitoring is provided in other EPA documents (EPA 1993a, 2008c). Building owners and occupants may find EPA's *Consumer's Guide to Radon Reduction* (EPA 2013b) a useful source of additional information, in light of similarities in technologies for reducing vapor intrusion and radon intrusion.

ICs may be necessary to help ensure the continued integrity of building mitigation systems. In many cases, therefore, ICs may accompany implementation of engineered exposure controls, for example to ensure that an active system remains operational and passive membranes are not disturbed (EPA 2008c). Additional information about ICs is provided in Section 8.6.

### 8.2.1 Prompt Response Options for Existing Buildings

For buildings with potential explosion and fire hazards, EPA recommends evacuation, along with notification of the local fire department about the threat. If, on the other hand, prompt action is warranted to reduce or eliminate vapor intrusion exposures in an existing building (e.g., measured indoor air concentrations pose an unacceptable human health risk for an acute or short-term exposure scenario (see Section 7.5.2)), it may be appropriate to implement response options such as the following:

- Sealing major openings for soil gas entry, where known and identified;
- Over-pressurizing nonresidential buildings by adjusting the HVAC system;

- Installing, repairing, or maintaining vapor traps for sewer or drain lines that are sources of vapor intrusion;
- Increasing building ventilation, for example using fans or natural ventilation;
- Treating indoor air (e.g., adsorption using activated carbon); and
- Temporary relocation

The fore-going response actions may take several days to a few weeks to plan (e.g., arrange, design) and implement, which generally is quicker than other interim response actions (e.g., active depressurization technologies). The first three options seek to reduce or eliminate vapor entry into the building. The last three options seek to reduce, eliminate, or avoid vapors that have entered the building by vapor intrusion. Specifically:

- Vapor intrusion into the building via soil gas entry from vadose zone soils can be reduced by sealing foundational openings using products such as synthetic rubbers, acrylics, oil-based sealants, asphalt/bituminous products, swelling cement, silicon, epoxy or elastomeric polymers. EPA recommends screening the selected sealant(s) (e.g., checking the composition, relying upon manufacturer's data) to ensure they do not contain or emit vapor-forming chemicals that might pose a human health risk to building occupants. This interim mitigation approach is among the easiest and least expensive to implement; however, its effectiveness relies upon being able to identify and access openings for soil gas entry. EPA recommends appropriate monitoring of indoor air concentrations be conducted to ensure that sealing attains and sustains sufficient reduction in vapor intrusion. In some cases, however, sealing openings may not be capable of reducing indoor air concentrations to acceptable levels and/or some openings may not be visible and accessible. EPA recommends that this response option generally be supplemented by installing, operating, and maintaining an engineered exposure control (e.g., an active depressurization technology) that reduces or eliminates vapor entry into the building until remediation of subsurface vapor sources is complete and terminated.
- For commercial and industrial buildings where HVAC units blow air into the building and are well maintained, it may be advantageous to increase pressurization in the building to prevent or reduce vapor intrusion. In some cases (e.g., buildings with few doors and other openings), relatively small increases in building pressure may be sufficient, which may be accomplished by increasing the air flow rate and using specialized equipment to monitor and balance air flow rates. EPA recommends appropriate monitoring of pressure and other indicators (e.g., indoor air monitoring) be conducted to ensure that adequate pressurization is sustained throughout areas of the building that could be subject to vapor intrusion. In some climates and for some buildings, this response option may be impractical or prohibitively expensive.
- Vapor intrusion into the building via gas entry from sewer and drain lines can be reduced or eliminated by installing, repairing, and maintaining vapor traps.
- Increasing building ventilation (i.e., increasing the rate at which indoor air is replaced with outdoor air) can reduce the buildup of indoor air contaminants within a structure. Natural ventilation may be accomplished by opening windows, doors, and vents. Forced

or mechanical ventilation may be accomplished by using a fan to blow air into or out of the building. Increased ventilation is easiest and least costly to implement in locations where the air is not conditioned (heated or cooled). If indoor air is conditioned, increased ventilation can be a costly option because the conditioned air is ventilated to the outdoors. This drawback can be partly overcome by use of heat exchangers, but they are also costly. Another concern is that exhausting air from the building will generally contribute to under-pressurization of the building, relative to the subsurface, thereby potentially resulting in an increased rate of soil gas entry (i.e., vapor intrusion) unless ambient air entry into the building is increased equivalently. EPA recommends appropriate monitoring of indoor air concentrations be conducted to ensure that ventilation attains and sustains sufficient reduction in exposures to vapor-forming chemicals. In some cases, ventilation may not be capable of reducing indoor air concentrations to acceptable levels. In addition, building occupants may find it uncomfortable to increase the air exchange rate by more than a factor of three or four. EPA generally recommends that this response option be supplanted, when feasible, by installing, operating, and maintaining an engineered exposure control that reduces or eliminates vapor entry into the building until remediation of subsurface vapor sources is complete and terminated.

- Commercially available indoor air cleaners, which include both in-duct models and portable air cleaners, is another response option. These devices operate on various principles, including zeolite and carbon sorption and photocatalytic oxidation. Methods that rely on adsorption generate a waste that must be disposed of appropriately or regenerated and warrant periodic replacement of the adsorption medium. EPA recommends appropriate monitoring of indoor air concentrations be conducted to ensure that adequate treatment is sustained throughout the building. EPA generally recommends that this response option be supplanted, when feasible, by installing, operating, and maintaining an engineered exposure control that reduces or eliminates vapor entry into the building until remediation of subsurface vapor sources is complete and terminated.
- Temporary relocation may be implemented for buildings where conditions warranting prompt response action (see Section 7.5) and cannot be adequately addressed by other means.<sup>218</sup>

None of these options entails reducing the level of vapor-forming contamination in the subsurface medium (see Section 8.1). EPA generally recommends that these response options be supplanted, when feasible, by installing, operating, and maintaining an engineered exposure

---

<sup>218</sup> For response actions carried out under Sections 104(a) and 106(a) of CERCLA, OSWER Directive 9230.0-97 (*Superfund Response Actions: Temporary Relocations Implementation Guidance* (EPA 2002d)) states: "Temporary relocation should not be selected if health and safety risks or circumstances that pose an unreasonable inconvenience can be adequately addressed by other means without significantly increasing the overall cost or duration of the response action." Similarly, OSWER Directive 9355.0-71P (*Interim Policy on the Use of Permanent Relocations as Part of Superfund Remedial Actions* (EPA 1999f)) states: "EPA's preference is to address the risks posed by the contamination by using well-designed methods of cleanup which allow people to remain safely in their homes and business." OSWER Directive 9230.0-97 provides recommended procedures and other policies for temporarily relocating residents when this response action is selected and implemented under Sections 104(a) and 106(a) of CERCLA.



control that reduces or eliminates vapor entry into the building (see Section 8.2.2), until remediation of subsurface vapor sources is complete and terminated.

### 8.2.2 Active Depressurization Technologies for Existing Buildings

This section provides a brief overview of engineered systems that can be used to reduce or eliminate soil vapor intrusion in existing buildings, along with a summary of steps and considerations for selecting an appropriate technology for a given building. The focus is on active depressurization technologies most commonly employed for reducing soil vapor intrusion into buildings. This focus does not mean, however, that active depressurization technologies are always preferred over other mitigation methods or that they will be the best option for every site. More detailed information on vapor intrusion mitigation systems for existing buildings, including sub-membrane ventilation systems and passive technologies,<sup>219</sup> can be found in several EPA publications (e.g., EPA 2008c).

Active depressurization technologies (ADT) have been used successfully to mitigate the intrusion of radon into buildings and have also been successfully installed and operated in residential, commercial, and school buildings to control vapor intrusion from subsurface vapor-forming chemicals. ADT systems are widely considered the most practical vapor intrusion mitigation strategy for most existing buildings, including those with basement slabs or slab-on-grade foundations. ADT systems are generally recommended for consideration for vapor intrusion mitigation because of their demonstrated capability to achieve significant concentration reductions in a wide variety of buildings<sup>220</sup> and their moderate cost.

Sub-slab depressurization (SSD) systems, a common type of ADT system, function by creating a pressure difference across the building slab to prevent soil gas entry into the building (i.e., overcoming the building's natural under-pressurization, which is the 'driving force' for vapor intrusion; see Section 2.3). Creating this pressure difference is accomplished by extracting soil gas from beneath the slab and venting it to the atmosphere.<sup>221</sup> For the system to be effective by this mechanism,<sup>222</sup> this soil depressurization must be established and maintained at least near the primary openings for soil gas entry (EPA 1993a). Construction of SSD systems entails opening one or more holes in the existing slab, removing soil from beneath the slab to create a "suction pit" (6–18 inch radius), placing vertical suction pipes into the holes, and sealing the

---

<sup>219</sup> As noted in Section 3.3, engineered exposure controls that do not involve mechanical operations (e.g., creating a barrier between the soil and the building that blocks openings from soil gas entry into the building) are referred to as "passive."

<sup>220</sup> Folkes and Kurz (2002) describe a case study of a vapor intrusion mitigation program in Denver, Colorado. Sub-slab depressurization systems and/or sub-membrane depressurization systems were installed in 337 residential homes to control indoor air concentrations of 1,1-dichloroethylene (DCE) resulting from migration of vapors from groundwater with elevated 1,1-DCE concentrations. Over three years of monitoring data for 301 homes have shown that these systems are capable of achieving the very substantial reductions in concentrations in indoor air. Approximately one quarter of the systems warranted minor adjustment or upgrading after initial installation in order to achieve the state standards established for indoor air exposure.

<sup>221</sup> Depending, in part, upon location and prevailing statutes and regulations, governmental permits or authorizations may be required for venting systems that exhaust to the atmosphere.

<sup>222</sup> A second mechanism by which ADT systems can function is diluting the vapor concentrations beneath the slab and foundation (EPA 1993a, 2008c). Engineered controls designed and operated to use this mechanism predominately are often referred to as sub-slab ventilation systems.

openings around the pipes. These pipes are then connected together to a fan, which draws soil gas from the sub-slab area through the piping and vents it to the outdoors.<sup>223</sup> Sealing known and accessible openings in the slab and foundation can reduce the flow rate of conditioned indoor air that can be pulled into the sub-slab region by the suction wells and the sub-slab depressurization (EPA 2008).

SSD systems were first developed for radon reduction (EPA 1993a) and operate under similar design principles as radon mitigation methods. Figure 8-1 illustrates such an SSD system.

When sumps and associated drain tile systems are present, they may also be depressurized to prevent soil gas entry into the building (again, overcoming the building's natural under-pressurization). This variation on active depressurization is often referred to as drain-tile depressurization (DTD). Depressurization of drain tiles located near a foundation wall can help control soil gas entry at the joint between the foundation wall and slab. Figure 8-2 illustrates such a DTD system.

If the building has hollow block walls, the usual sub-slab suction point may not adequately mitigate the wall cavities, which may be particularly important if the outside surfaces are in contact with the soil. In these situations, the void network within the wall may be depressurized by drawing air from inside the wall and venting it to the outside. This method, called "block-wall depressurization" (BWD) is often used in combination with SSD. Because uniform depressurization of block walls can be difficult, BWD is generally recommended only when sub-slab or DTD prove inadequate to control vapor intrusion. Figure 8-3 illustrates such a BWD system.

In buildings with a crawl space foundation or a basement with a dirt floor, a flexible membrane may be installed over the floor to facilitate depressurization of the soil gas beneath the membrane, which prevents vapors from intruding into the crawl space or basement air. To maximize the effectiveness of a sub-membrane depressurization (SMD) system, EPA recommends the membrane cover the entire floor area and be sealed at all seams and penetrations. Figure 8-4 illustrates such an SMD system.

Extensive guidance is available for the design, sizing, installation, and testing of ADT systems for radon control in existing and new homes and large institutional (e.g., school) and commercial buildings. EPA recommends that ADT systems be designed and installed by qualified persons, typically environmental professionals and licensed radon contractors. EPA guidance for design of ADT systems can be found in several publications (e.g., EPA 1993a, 2008c). EPA recommends documenting each constructed ADT system via a system manual, as described further in Section 8.5.

The Vapor Intrusion Mitigation Quick Guide provided in Table 8-1 summarizes a list of steps for selecting and implementing a vapor intrusion mitigation system in existing buildings.

---

<sup>223</sup> A central issue that determines the design and effectiveness of ADT systems is the ease with which suction at one location can extend to other subsurface areas underneath the building. Where a good and uniform layer of aggregate (e.g., gravel or crushed rock) was placed underneath a slab foundation during construction, for example, such hydraulic control and communication can generally be expected to be good (EPA 1993a). Where the layer of aggregate under a slab is interrupted or uneven to a significant degree, additional suction pipes will generally be needed and their location will be increasingly important.

## TABLE 8-1 VAPOR INTRUSION MITIGATION QUICK GUIDE FOR EXISTING BUILDINGS

### Step 1: Consider Prompt Response Actions

It may be appropriate to implement certain interim measures before engineered controls are constructed and operated, as warranted and feasible. For example, building ventilation can be increased, cracks and other openings in the floor or foundation (that otherwise allow soil gas entry) can be sealed, or indoor air treatment can be conducted (refer to Section 8.2.1).

### Step 2: Select a Building Mitigation System

The initial step in selecting the appropriate vapor intrusion mitigation technology is to conduct a visual inspection of an existing building. The selection of a vapor intrusion mitigation system primarily depends on building characteristics and contaminant concentrations. In the majority of cases, a type of active depressurization technology (ADT) can be an efficient, reliable, and cost-effective vapor intrusion mitigation technique. In some cases, however, other approaches may be preferable.

Factors that may prompt consideration of vapor intrusion mitigation approaches other than ADT include foundation conditions that prevent development and extension of a suction field below the building.

If there are no factors that would rule out an ADT technology, appropriate systems that can be considered include:

- Sub-slab depressurization (SSD) systems, particularly in houses having slabs (basements and slabs on grade) where drain tiles are not present.
- Drain-tile depressurization (sump/DTD or remote discharge/DTD) when drain tiles are present.
- Sub-membrane depressurization (SMD) in buildings with a crawl space foundation or a basement with a dirt floor,
- Block-wall depressurization (BWD), usually used only as a supplement to SSD, DTD, or SMD to better mitigate vapors found to be migrating through the wall.

### Step 3: Design Building Mitigation System

EPA recommends the final detailed design of the selected vapor intrusion mitigation technology specify the number and location of suction points, location and size of piping, suction fan, piping network and exhaust system, and sealing options to be used in conjunction with the ADT technology. Pre-mitigation diagnostic testing can provide information about the suction field underneath a building and pressure differences that will need to be overcome (EPA 1993a) if the ADT system is to be effective. Diagnostic testing during installation can also help verify the adequacy of the design.

### Step 4: Install Building Mitigation System

EPA recommends that the vapor intrusion mitigation system be installed consistent with design specifications by equipment manufacturers, local permit conditions and regulations, and relevant industry standards.

### Step 5: Confirm the Installed System is Operating Properly

EPA recommends a visual inspection of the installed system as a routine quality assurance step to confirm that all construction details have been completed. Post-construction monitoring is recommended (refer to Section 8.4) to demonstrate the ADT system is operating appropriately and effectively. Where a vapor intrusion mitigation system is not performing adequately, post-construction diagnostic tests can be helpful in trouble-shooting (EPA 1993a).

### Step 6: Ensure Proper Operation and Maintenance of Vapor Intrusion Mitigation System (refer to Sections 8.3 and 8.4)

EPA recommends proper system maintenance and periodic inspections and monitoring to ensure the system is operating as designed and is effective at reducing indoor air concentrations to (or below) target levels. EPA recommends that site managers provide the building owner/occupant with information to help ensure proper operation and maintenance of the system.

EPA recommends that periodic inspections include periodic measurements to confirm that the building mitigation system is continuing to perform adequately.

The U.S. Navy has issued a concise fact sheet that contains useful technical information (DoN 2011b).

### 8.2.3 Approaches and Considerations for New Buildings

The ADT systems described above are generally available for new buildings also. However, a wider array of approaches and technical options is typically available to mitigate or avoid vapor intrusion for new buildings, compared to existing buildings. These options potentially include the choice of building location and opportunities to modify the building design and construction, which are not available for existing buildings. For example:

- At some sites, contaminated areas most likely to produce unacceptable vapor intrusion exposures can be avoided and designated for another purpose, such as recreational space or undeveloped landscape.
- Mitigation needs can also be considered in the selection of heating and cooling systems, which are normally selected based only on economics, aesthetics, preference, and custom. A system design that avoids creating under-pressurization inside the structure and maintains over-pressurization inside the structure may be effective in mitigating vapor intrusion.
- Passive barriers, such as a low-permeability membrane, can be more readily installed between the soil and the building during new building construction. Passive barriers are intended to reduce vapor intrusion by limiting openings for soil gas entry. However, passive barriers as stand-alone technologies may not adequately reduce vapor intrusion owing to difficulties in their installation and the potential for perforations of the barrier during or after installation. They are commonly combined with ADT systems or with sub-membrane ventilation systems to help improve their efficiency.
- Venting layers can be more readily installed between the soil and the building during new building construction.<sup>224</sup>
- New buildings may be designed to include a highly ventilated, low-occupancy area at ground level, such as an open parking garage.

Steps 2-6 of the Vapor Intrusion Mitigation Quick Guide provided in Table 8-1 are also pertinent to newly constructed buildings. EPA guidance for selecting, designing, and installing vapor intrusion mitigation systems for new buildings can be found in several publications (e.g., EPA 2008c). The U.S. Navy has issued a concise fact sheet that contains useful technical information (DoN 2011c).

---

<sup>224</sup> Constructed sub-slab ventilation systems typically consist of: a venting layer (e.g., filled with porous media such as sand or pea gravel; or suitably fabricated with continuous voids) below a floor slab to allow soil gas to move laterally to a collection piping system for discharge to the atmosphere; and a sub-slab liner that is installed on top of the venting layer to reduce entry points for vapor intrusion. These and other sub-slab ventilation systems function by drawing outside air into and through the sub-slab area, which dilutes and reduces concentrations of vapor-forming chemicals, and provides a route for soil gas to vent to the atmosphere or migrate outside the building footprint, rather than into a building.

### 8.2.4 Owner/Occupant Preferences and Building Access

Building owners and occupants can initially be notified in various ways that their home or building warrants construction and operation of a building mitigation system. Section 9.5 provides information regarding such notifications and other messages pertaining to building mitigation.

Whereas EPA managers and mitigation system designers may be primarily concerned with the performance, cost-effectiveness, and reliability of any mitigation system, the building owners and occupants may have additional perspectives and opinions that warrant consideration during technology selection, design, construction, and operation. For example, owners and tenants will often have strong opinions about where fans and piping are located, what level of fan noise is acceptable, and what quality of construction craftsmanship is satisfactory. When there are multiple mitigation options (for example, at a large commercial building), EPA recommends these options be presented fairly to the building owner and tenants, explaining the advantages and disadvantages associated with each and describing the rationale for the preferred alternative.

In some cases, obtaining and scheduling access to a building can be difficult, whether the structure is a commercial or institutional building or a private residence. Commercial building tenants may not want construction activities disrupting business operations. Some homeowners/tenants may resist granting access to their home. Other homeowners/tenants may prefer to schedule tests before or after their work-day. To address these practical and logistical concerns, EPA recommends that an access agreement(s) be executed between the property owner, any tenants, and the mitigating entity to ensure appropriate access as needed to operate, maintain, and monitor the engineered exposure controls in each impacted building.

### 8.3 Operation and Maintenance of Vapor Intrusion Mitigation Systems

For purposes of this Technical Guide, operation and maintenance (O&M) is used generically to refer to periodic inspections, component maintenance or replacements, repairs, and related activities that are generally necessary to ensure continued operation and effectiveness of engineered exposure controls to mitigate vapor intrusion. EPA generally recommends that such O&M activities be conducted routinely, be documented in an O&M plan (as described further in Section 8.5), and consider recommendations of equipment manufacturers, if any, and site-specific factors. Additional information about ensuring continued effectiveness of systems is available in EPA (2009b).

Design specifications for vapor migration systems may include (1) a maintenance frequency that varies over the operating period of the mitigation system and/or (2) a provision to evaluate and modify the frequency based on data or information obtained during monitoring and maintenance. For example, it may be acceptable to reduce inspection or maintenance frequency once efficient system operation has been demonstrated for at least an initial year, with triggers for additional, unscheduled inspections following alarms (from warning devices) and floods, earthquakes, and building modifications, if any.

Typical O&M activities for either passive or active systems may include, but are not limited to:

- Routine inspection of all visible components of the vapor intrusion mitigation system, including fans, piping, seals, membranes and collection points, to ensure there are no

signs of degradation or blockage. EPA recommends that the as-built drawing for the vapor intrusion mitigation system be examined to verify the system configuration has not been modified.

- Visual inspection of the building to evaluate whether any significant changes were made (such as remodeled basement, new furnace) that would affect the design of the vapor intrusion mitigation system or the general environment in which it is operated. A crawl space SMD membrane, for example, may warrant repair or replacement if its integrity is compromised.
- Visual inspection of the area of concern (including basement floor and wall seals, sumps, floor drains and utility penetrations) to ensure there are no significant changes in conditions that would warrant modification of the system design.
- Routine monitoring of vent risers for flow rates and pressures generated by the fan to confirm the system is working and moisture is draining correctly.
- Routine maintenance, calibration and testing of functioning components of the venting system consistent with the manufacturers' specifications.
  - Pressure readings for both active and passive depressurization systems as well as positive pressurization systems (e.g., periodic verification of measurable pressure differences across the slab).
  - Confirmation that the extraction fan is operating.
  - SSD system fans generally can function well for prolonged periods without maintenance; however, EPA recommends fans be replaced periodically throughout the operating life of the system (e.g., every 4 to 10 years) to avoid breakdowns and associated problems.
- Inspection of external electrical components to identify undesirable conditions, such as excessive noise, vibration, moisture, or corrosion, and to verify that the fan cut-off switch is operable.
  - Inspection of the fan(s) is important throughout the operating period but may be particularly important near the end of its expected lifespan. Noisy fans typically indicate problems with ball bearings and warrant replacement on that basis.
  - Confirmation of adequate operation of the warning device or indicator.
- Confirmation that building owner/occupants are knowledgeable about how to maintain system operation. Confirmation that a copy of the O&M manual is present in the building and has been updated as necessary.

EPA also recommends that the site team determine if there has been any change in ownership/occupant. If such a change has occurred, EPA recommends the site manager work with the new owner/occupant to ensure continued integrity and operation of the vapor intrusion mitigation system.

## 8.4 Monitoring of Vapor Intrusion Mitigation Systems

Regardless of the type of system selected for mitigating vapor intrusion in a given building, EPA recommends monitoring to demonstrate that performance standards are achieved at the time of installation and that those performance standards continue to be met throughout the operating period of the mitigation system. EPA recommends that any monitoring program developed for a building mitigation system be based upon site-specific considerations, including the degree of risk or hazard being mitigated, the building use, the technology used to mitigate vapor intrusion, whether the subsurface vapor source(s) is stable in extent and concentration, and coordination with site remediation efforts. For example:

- An older building with highly volatile chemicals at high concentrations may need a more intense level of monitoring than a new building with lower concentrations of less volatile chemicals.
- Passive systems are generally less predictable and less efficient at preventing vapor intrusion than active systems and, therefore, typically warrant more intensive monitoring, all else being equal.
- When contaminated groundwater plumes are migrating to new areas (i.e., expanding) or concentrations in shallow groundwater are increasing, increased frequency and intensity of mitigation monitoring may be warranted.
- During start-up, some remediation methods have the potential to alter soil gas conditions in ways and to a degree that may be difficult to predict. Increased frequency and intensity of mitigation monitoring may be warranted when such remediation methods are implemented near buildings undergoing mitigation.

Mitigation monitoring will generally entail two phases: (i) an initial post-construction phase, which is generally more intensive; and (ii) a subsequent phase, which may be comprised of fewer diagnostic tests to be conducted periodically. As with radon mitigation systems (EPA 1993a, Section 11.1.2), results of indoor air sampling during initial post-construction monitoring may be used to demonstrate that the occupant's exposure to vapor-forming subsurface contaminants has been reduced as anticipated. In addition, pressure field measurements in the subslab region can be used to demonstrate that the system has attained hydraulic control and communication (e.g., depressurization in the case of an ADT system) over the footprint of the building (or portion of a large building, as appropriate, considering the extent of subsurface contamination). Adjustments to the mitigation system and/or additional diagnostic testing (EPA 1993a, 1993c) may be warranted if the results of such testing do not clearly demonstrate that the system is achieving its intended performance and effectiveness. Once an adequate demonstration of effectiveness has been made for the vapor intrusion mitigation system, periodic monitoring is recommended to verify that this performance is sustained; for this purpose, monitoring may be comprised of fewer types of tests than during the immediate post-construction (i.e., start-up) phase at the discretion of EPA when the subsurface vapor source(s) is stable. Examples of various monitoring scenarios for these two phases are provided in Table 4 of CalEPA (2011), Table 6-2 of NJDEP (2012), and Table 3-1 of MADEP (2011). Additional information about ensuring continued effectiveness is available in the *Operational and Functional Determination and the Transfer of Fund-lead Vapor Intrusion Mitigation Systems to the State* (EPA 2009b).

When monitoring to assess the performance and effectiveness of building mitigation technologies, EPA recommends employing the methods, approaches described in Sections 5.4, 6.2, 6.4 and 7.0 of this Technical Guide. EPA also recommends that monitoring programs that assess the performance and effectiveness of remediation and mitigation systems be documented, preferably in work plans similar to those recommended herein for characterizing and assessing the vapor intrusion pathway (see Section 6.2). Such vapor intrusion monitoring plans may be incorporated as part of a comprehensive remedial design and operations manual or as a stand-alone document, depending upon site-specific circumstances. In addition, EPA recommends that data and other results obtained through such monitoring programs be documented (e.g., in the administrative record), as they become available.

The remainder of this section identifies and further discusses some elements commonly incorporated in monitoring programs for active depressurization technologies.

### ***Pressure Measurements***

Sub-slab probes can be used to monitor differential pressures for a direct indication of the hydraulic performance of ADT systems (i.e., the pressure difference across the slab prevents soil gas entry); see Section 2.3. For basements, the walls that are underground become part of the critical building envelope that must prevent soil gas entry. For subsurface depressurization systems, EPA recommends that the pressure gauge be monitored quarterly to verify the system is operating efficiently. A reduced monitoring frequency may be appropriate after one year of successful operation of the remedial system.

### ***Tracer Testing***

Openings within the building or leaks in the mitigation system can affect system performance. Tracers can be used either for leak detection through barriers, building materials or system components (piping, for example) or to measure the air exchange rate in the building.

Smoke testing is a qualitative form of tracer testing used to detect leaks (e.g., at seams and seals of membranes in SMD systems or at potential leakage points (openings) through floors above sealed crawl space systems or through conduits that facilitate preferential vapor migration), or to test airflow patterns. A limitation of smoke testing in existing structures is that non-noxious smokes can be expensive, and cheaper high-volume smoke sources can leave undesirable residues. The efficacy of smoke testing in some applications has been questioned on the grounds that many leaks are too small for visual detection using this method (Maupins and Hitchins 1998, Rydock 2001), and that leaks large enough to detect using smoke could be detected other ways. More quantitative methods have been recommended, such as tracer testing with instrumentation for quantitative results.

### ***Air Sampling***

Once an adequate demonstration of vapor intrusion mitigation system effectiveness has been made, indoor air quality generally will be acceptable as long as an adequate pressure difference is maintained throughout the footprint of the building. Periodic or intermittent sampling of indoor air, nevertheless, warrants consideration, since indoor air data can provide direct confirmation that the system is reducing exposure levels of vapor-forming chemicals and because depressurization technologies can be expected to alter the distribution of vapors in the vadose zone and available for soil gas entry, if any.



### ***Weather-Related Considerations***

EPA recommends that weather conditions be noted during monitoring activities (EPA 1993a). Weather conditions, such as temperature and precipitation, can affect the performance of a vapor intrusion mitigation system. For example, cold temperatures may increase the building depressurization created by the thermal stack effect and thus increase the driving force for soil gas entry, depending upon the height of the house and the temperature difference between indoors and outdoors (see Section 2.3). As a result, the ADT system may need to overcome more building depressurization than originally considered when designed. Precipitation may also increase moisture in the fill under the slab, which may affect the performance of the system, and is a factor to consider in developing a monitoring program.

### ***Alarms***

Alarms generally are used as part of a monitoring program to ensure that malfunctions of vapor intrusion mitigation systems are timely and readily detected and addressed. According to ASTM (2003), "All active radon mitigation systems shall include a mechanism to monitor system performance (air flow or pressure) and provide a visual or audible indication of system degradation and failure" (i.e., an 'alarm'). ASTM goes on to say, "The mechanism shall be simple to read or interpret and be located where it is easily seen or heard. The monitoring device shall be capable of having its calibration quickly verified on site." Such devices may indicate operational parameters (such as on/off or pressure indicators) or hazardous gas buildup (such as percent LEL indicators). EPA concurs with the cited advice from ASTM and recommends it be considered when monitoring and maintaining mitigation systems for vapor-forming chemicals and sites addressed by this Technical Guide.

In particular, EPA recommends that system failure alarms be installed on active depressurization systems, and appropriate responses to alarms be communicated by the building owner/occupants. EPA also recommends that alarms be placed in readily visible, frequently trafficked locations within the respective building and their proper operation be confirmed on installation and monitored periodically.

### ***Placards***

EPA also recommends that permanent placards be placed on the system to describe the system's purpose and operational requirements (e.g., power source) and instructions on what to do if the system does not operate as designed (for example, a phone number to call for corrective action). EPA recommends the placard provide information about how to read and interpret the monitoring instruments or warning devices provided. EPA also recommends that these placards be placed as close to the monitoring/alarm part of the system as possible, as well as close to the fan or other active parts of the system.

## 8.5 Documentation of Engineered Exposure Controls for Vapor Intrusion Mitigation

EPA recommends that documentation be provided to building owners and occupants and appropriate regulatory agencies<sup>225</sup> describing the vapor intrusion mitigation system (i.e., a 'system manual') and its associated O&M (i.e., an 'O&M plan'). The system manual provides a detailed record about the mitigation system, including as-built drawings, permits (if any), copies of agreements, and construction/layout plans, whereas the O&M manual describes the O&M activities to be conducted routinely and identifies which party is responsible for these O&M activities. Additional information about ensuring continued effectiveness is available in *Operational and Functional Determination and the Transfer of Fund-lead Vapor Intrusion Mitigation Systems to the State* (EPA 2009b).

### *O&M Plan*

O&M plans generally are prepared on a site-specific basis, and they often are particularly useful at sites where:

- Monitoring is needed to verify remedial effectiveness.
- The remedial system warrants periodic adjustments and maintenance.
- Human health risk would result if the system fails or if site conditions change.
- Conditions that would trigger specific contingent response may occur sporadically or episodically.

Some site remedial systems may also warrant the use of a regulatory agency-approved contingency plan or similar corrective response document approved by the regulatory agency to identify conditions that may trigger the need for additional maintenance, collection of additional data, modifications of monitoring frequency, or other responses to ensure the remedy remains effective.

Communication with building owners and occupants about vapor intrusion and the O&M of a vapor intrusion mitigation system is critically important. For example, building owners may be concerned about some aspect of system operation and decide to turn it off. It is important to communicate that turning off the system may result in harmful indoor air concentrations inside the building.

### *System Manual*

The specific contents of the system manual will depend on the type of system. EPA recommends, however, that the system manual generally include at least the following information or items:

- Cover/transmittal letter;

---

<sup>225</sup> For example, EPA recommends the potentially responsible party (PRP) provide a system manual and O&M plan to EPA at PRP-lead Superfund sites.

- Description and diagram of final as-built system layout with components labeled;
- Building permits for a vapor intrusion mitigation system;
- Pre- and post-mitigation air and gas sampling data;
- Pre- and post-mitigation diagnostic test data;
- Copies of contracts and warranties;
- Proper operating procedures of the system;
- Contact information of the contractor or installer;
- Copy of signed access agreement;
- Copy of vapor mitigation system O&M agreement;
- Copy of pre-mitigation sample result letter (see Section 9.4);
- Copy of post-construction sample result letter;
- Contact information in case of future questions; and
- Inspection and maintenance guidelines.

### *User's Guide*

Documentation typically is also provided to the property owner and occupant in the form of a user's guide suitable to keep lay persons informed about the system and to provide a summary reference in case questions or issues arise pertaining to the system.

A user's guide is a brief summary of why a vapor intrusion mitigation system was installed at a property and how the system works, and may include the following: (1) a brief description of the system and its proper range of operation; (2) contact information for the party responsible for responding to malfunctions and ensuring the system performs properly; and (3) information about routine maintenance to be conducted by the owner/occupant, if any. EPA recommends that a user's guide be placed near the system for quick access and easy reference (e.g., into a clear protective sleeve and attached to the main extraction pipe of the ADT system). An easy-to-read user's guide may be especially helpful at rental properties because the guide informs each new tenant about what the system is and why it was installed.

## **8.6 Use of Institutional Controls**

ICs may be used to restrict certain land uses, buildings, or activities that could otherwise pose an unacceptable human exposure via the vapor intrusion pathway.

Response actions for vapor intrusion may include ICs to restrict land use for protection of human health regardless of whether a vapor intrusion mitigation system provides interim measures to control (i.e., reduce, limit) human exposures. ICs can be used as either an interim

response until site cleanup goals are reached or as part of a long-term response where vapor-forming waste remains in place.

General EPA guidance on ICs is provided in *Institutional Controls: A Guide to Planning, Implementing, Maintaining, and Enforcing Institutional Controls at Contaminated Sites* (“PIME IC Guidance”) (EPA 2012d). As discussed in the PIME IC Guidance, ICs are non-engineered instruments, such as administrative or legal controls, that help to minimize the potential for human exposure to contamination and protect the integrity of a response action. ICs typically operate by imposing land or resource use restrictions at a given site or by conveying notice to stakeholders regarding subsurface contamination or the possible need to refrain from certain actions that may result in human exposure to hazardous chemicals. For example, ICs may be used to restrict the development and use of properties for certain land uses (e.g., prohibiting residential housing, hospitals, schools, and day care facilities).

In some situations, ICs can be used to restrict access to a property, facilitate response activities conducted by a responsible party or EPA, such as the installation or maintenance of vapor intrusion mitigation systems, or help ensure the integrity of vapor mitigation systems. ICs may also be used to help inform the need for vapor intrusion mitigation for future construction where vapor-forming waste remains in place and may pose unacceptable human health risk due to vapor intrusion.

As described further in Section 2.2 of the PIME IC Guidance, ICs can be described in four general categories:

- Proprietary controls.
- Governmental controls.
- Enforcement and permit tools with IC components.
- Informational devices.

The first three categories (i.e., proprietary controls, governmental controls, and enforcement and permit tools with IC components) typically memorialize and prescribe substantive use restrictions concerning the land or resource use, while informational devices generally operate to provide notice of contamination and any remedial activities to parties. Depending on the nature of the site and the particular jurisdiction in which it is located, certain instruments may not be available or feasible for a particular site. Certain ICs may help facilitate how interim response actions and subsurface remediation are carried out, such as provisions addressing access, O&M of vapor intrusion mitigation systems, and design specifications for buildings (see Example #3 box below).

### 8.6.1 Evaluating ICs in the Overall Context of Response Selection

As a site moves through a program's response selection process (for example, a Superfund remedial investigation/feasibility study [RI/FS] or RCRA facility investigation/corrective measures study [RFI/CMS]), EPA recommends that site managers develop information about reasonably anticipated future land uses and infer reasonably expected exposure pathways related to land use. This information may be incorporated in the conceptual site model and often can be used to evaluate whether ICs will be needed to ensure protectiveness of current and

reasonably anticipated future land uses over time. EPA's land use guidance (EPA 1995a, 2010c) recommends that the site manager discuss reasonably anticipated future land uses of the site with local land use planning authorities, local officials, property owners, and the public, as appropriate, as early as possible during the scoping phase of the RI/FS, RI/CMS, or equivalent phase under other cleanup programs.

EPA recommends that the Region's decisions to implement ICs be documented in proposed cleanup plans and in final cleanup decision documents. For example, for CERCLA cleanups, the proposed restriction, and need for ICs would normally be identified in the Proposed Plan for notice and opportunity to comment by potentially affected landowners and the public. Such use restrictions or notices typically are then selected and memorialized in the Record of Decision (ROD).

In some cases, unanticipated changes in land use may occur after the response action is implemented, which may impact the protectiveness of a completed response action and raise questions concerning the effectiveness of the ICs. As a result, vapor intrusion may be identified as a potential human exposure pathway in a subsequent periodic review. In this case, EPA recommends that site managers evaluate options for modifying the original response decision, including the need for new or additional ICs consistent with existing and reasonably anticipated future land uses and other response selection considerations.

#### 8.6.2 Common Considerations and Scenarios Involving ICs

The evaluation of whether an IC is needed at a contaminated site, including one where the vapor intrusion pathway poses a current or potential threat to human health, is a site-specific determination. When evaluating whether an IC will be needed, EPA recommends that EPA Regional staff consider whether the site meets unlimited use and unrestricted exposure (UU/UE), among other factors. UU/UE is generally the level of cleanup at which all exposure pathways present an acceptable level of human health risk for all land uses, including reasonably anticipated future land use scenarios that are considered during response selection.

Common scenarios where ICs may be a useful instrument for fostering protectiveness at a site involving vapor intrusion threats include, but are not limited to, the following:

1. Existing buildings overlie soil or groundwater contamination, or a migrating groundwater plume that is moving toward existing buildings potentially poses a future vapor intrusion threat;
2. Future construction is planned or is reasonably anticipated on a site that overlies subsurface contamination with vapor-forming chemicals;
3. Changes to building construction/design (such as remodeling or ventilation changes) or building use (such as commercial building converted for residential use) potentially affect exposure to the vapor intrusion pathway;
4. Vapor intrusion mitigation systems are needed in buildings, or existing ventilation systems are being utilized for vapor intrusion mitigation, and continued access is sought to facilitate their O&M;

5. Response actions to reduce source contamination will not immediately meet response objectives; and
6. Response actions to reduce or eliminate source contamination will not be taken (for example, where it is technically impracticable to treat groundwater that is the source of vapor intrusion).

Informational ICs may also serve to provide notice to parties, including prospective purchasers, about what land or building uses are compatible with human health risk that may be posed by vapor intrusion at the site. For example, modifications to a building's ventilation or air conditioning system may affect building under-pressurization in a way that fosters a greater potential vapor intrusion threat. Various ICs can be tailored to address construction and design specifications of both existing and future buildings—a local ordinance, for example, may require parties to submit a building design to its building department that incorporates mitigation measures as determined appropriate by a Professional Engineer (P.E.) (see IC Example #1).

In addition to restricting land, building, or resource use, some types of ICs may provide an effective means for addressing O&M at vapor intrusion sites consistent with decision documents and enforcement documents. This could happen, for instance, when an IC specifies that mitigation systems be installed and maintained in future construction or if the use of an existing building changes (e.g., industrial building use changes to mixed commercial or residential uses). Provisions regarding access to and periodic maintenance and testing of the mitigation systems, and other site-specific obligations may be incorporated into the IC (see IC Example #2).

**IC EXAMPLE 1:****City of Mandan, North Dakota Ordinance No. 1002** (City of Mandan 2006)

In 2006, the City of Mandan, North Dakota, enacted an ordinance that created an Environmental Institutional Control Zoning District to define an area of downtown Mandan impacted by petroleum contaminated soil and groundwater and to establish ICs for the protection of human health and the environment. Among other provisions, the ordinance requires any person proposing redevelopment, demolition, excavation, grading, or construction activities at properties within the District to submit to the city administrator or their appointee a contingency plan, approved by the North Dakota Department of Health, to evaluate and manage any petroleum contaminated soils or groundwater and any potential petroleum vapor impacts. The contingency plan must be prepared by a P.E. with experience in the environmental field, and the plan must consider and protect against, among other things, the vapor intrusion pathway. In addition, the ordinance also provides for restrictions on construction of new structures within the District. In pertinent part, the ordinance provides:

“Any person proposing to construct a new structure within the District shall submit a design for that structure that incorporates engineered controls to mitigate the effects of the potential presence of petroleum in the subsurface to the city administrator or their appointee. The design must be prepared by a P.E. and the design must be approved by the North Dakota Department of Health and must meet additional applicable codes and standards relative to the presence of petroleum. The design shall protect the public health and the environment by considering, at a minimum a) historic water/product intrusion; b) historic petroleum vapor/odor issues; c) potential future water/product intrusion; and d) potential future petroleum vapor/intrusion. The design shall incorporate vapor barriers, venting system, groundwater suppression/collection, and specialized HVAC as determined appropriate by a P.E.”

**IC EXAMPLE 2: State IC Legislation**

Some states have enacted statutes that directly authorize proprietary controls for the purpose of preventing use in conflict with environmental contamination or remedies. These state statutes divide into ones modeled after the Uniform Environmental Covenants Act (UECA)<sup>226</sup> and other non-UECA statutes.<sup>227</sup> These UECA and non-UECA state statutes tend to provide advantages over traditional common law proprietary controls by reducing certain legal and management complications associated with their use. The Model UECA, for instance, contemplates that the grantee or “holder” of the “environmental covenant” may be given specific rights or obligations with respect to future implementation of the environmental covenant.<sup>228</sup> This ability to oblige parties to undertake affirmative actions at a site, such as long-term maintenance of a cap or O&M of a vapor intrusion mitigation system, through a UECA environmental covenant, is different from traditional common law proprietary controls.

Proprietary controls that bind current and subsequent landowners (that is, the proprietary control “runs with the land”) to use restrictions at properties, as well as oblige them to undertake affirmative obligations, may have utility at vapor intrusion sites. For instance, at a contaminated site in Bucks County, Pennsylvania, an environmental covenant executed pursuant to the Pennsylvania Uniform Environmental Covenants Act contained provisions to address vapor intrusion threats. In addition to provisions for access, annual inspections, compliance reporting, and other specifications related to cleanup activities, parties to the environmental covenant agreed to construct slab-on-grade buildings without basements and install vapor barriers as an engineered control to mitigate the potential for vapor intrusion as part of the eventual development of the property. Further, the environmental covenant provided that engineering plans for the vapor barriers first be submitted to and approved by EPA prior to construction. For examples of environmental covenants executed pursuant to the Pennsylvania Uniform Environmental Covenants Act, Act No. 68 of 2007, 27 Pa. C.S. §§ 6501-6517:

[http://www.depweb.state.pa.us/portal/server.pt/community/land\\_recycling\\_program/20541/uniform\\_environmental\\_covenants\\_act/1034860](http://www.depweb.state.pa.us/portal/server.pt/community/land_recycling_program/20541/uniform_environmental_covenants_act/1034860)

---

<sup>226</sup> UECA was developed by the National Conference of Commissioners on Uniform State Laws. See: [www.uniformlaws.org](http://www.uniformlaws.org).

<sup>227</sup> See, for example, Colo. Rev. Stat. § 25-15-320 (2011); Cal. Civ. Code § 1471 (2011).

<sup>228</sup> “Grantee” is a traditional property law term describing a person to whom property is conveyed. States that have passed legislation based on UECA have created different legal concepts specific to those jurisdictions. For example, UECA jurisdictions typically define “holder” and “environmental covenant” to reflect, respectively, the grantee and the servitude that imposes the land or resource use restrictions. The model UECA provides that “[h]older means the grantee of an environmental covenant...” See definition 6 in Section 2.0 of the model UECA.



### 8.6.3 Selecting the Right Instrument(s)

When evaluating potential IC instruments, EPA recommends that site managers and site attorneys balance the relative advantages and limitations of IC instruments under consideration—for example, consider legal implementation issues, jurisdictional questions, permanence and enforceability concerns—and select those that best achieve the response objectives. (IC Example #3 describes how these factors were considered at the Middlefield-Ellis-Whisman Study Area.)

EPA guidance on ICs provides detailed considerations regarding the selection of ICs and the relative strengths of the different categories of IC instruments.<sup>229</sup> Ultimately, the selection of ICs is a site-specific evaluation based on the characteristics of the site (for example, the nature and extent of the vapor intrusion threat) and the particular jurisdiction in which it is located. There are times when multiple IC instruments can be “layered” to best ensure protectiveness of the response action while meeting the response objectives outlined in the decision documents.<sup>230</sup>

Because many ICs are created pursuant to state and other non-federal laws, the authority to implement and otherwise oversee these ICs resides with government entities other than EPA. Units of local governments, for instance, typically have jurisdiction to implement, maintain, enforce, and terminate certain governmental controls, such as zoning ordinances and building permit conditions. Therefore, it is important to evaluate the capacity (financial, technical, etc.) and willingness of the entity ultimately responsible for taking over IC responsibilities prior to IC selection.<sup>231</sup> Site managers and site attorneys are encouraged to coordinate early with IC stakeholders so that adequate assurances may be acquired and then subsequently maintained as necessary over time.

Given the potential role of non-EPA entities, it may be appropriate for EPA to facilitate or recommend a process by which IC stakeholders provide similar assurances or otherwise reach a common understanding<sup>232</sup> regarding their respective IC responsibilities to ensure that selected ICs are effectively implemented, maintained, and enforced. At a vapor intrusion site, for example, a zoning ordinance may be effective in preventing or ensuring responsible future development of properties overlying a contaminated groundwater plume that presents a vapor intrusion pathway threat. Such zoning ordinances generally are designed and enacted by the local government. Once enacted, the ordinance must be followed and enforced for it to serve as an effective IC over its lifespan. One inherent limitation of governmental controls, however, is that their implementation, modification, and termination generally follow a legislative process

---

<sup>229</sup> See Site Manager’s IC Guide and Section 3.2 of the PIME IC Guide for a framework to consider when deciding among available ICs.

<sup>230</sup> See Section 3.2 of the PIME IC Guide for more discussion on layering ICs.

<sup>231</sup> See Section 3.8 of the PIME IC Guide on IC stakeholder capacity considerations.

<sup>232</sup> Parties may be able to provide assurances or otherwise reach a common understanding regarding their respective IC roles and responsibilities through various mechanisms that may be available under state law (for example, a Memorandum of Understanding, Memorandum of Agreement, Administrative Order on Consent, contract, City Resolution, or enforceable agreement, etc.). For additional discussion about obtaining or memorializing IC assurances, see Sections 3.3, 3.8, and 4.3 of the PIME IC Guide.

**IC EXAMPLE 3: Efforts to Address VI at the Middlefield-Ellis-Whisman Study Area**

The Middlefield-Ellis-Whisman (MEW) Study Area is composed of four separate CERCLA sites—Raytheon Corp., Intel Corp. (Mountain View Plant), Fairchild Semiconductor Corp. (Mountain View Plant), and portions of the former Naval Air Station Moffett Field Superfund site—and many distinct parcels with land uses including residential, commercial, and light industrial. In 2009, EPA finalized a Supplemental FS for the MEW Study Area that presented an evaluation of a variety of remedial alternatives that could be used to mitigate potential vapor intrusion into current and future buildings overlying the shallow plume of contaminated groundwater. The FS provided an analysis of ICs using the NCP evaluation criteria: overall protection of human health and the environment; long-term protectiveness and permanence; compliance with applicable or relevant and appropriate requirements; reduction of toxicity, mobility, or volume through treatment; short-term effectiveness; implementability; and cost. The other two NCP evaluation criteria, state acceptance and community acceptance, were evaluated in the ROD Amendment for the vapor intrusion pathway remedy at the MEW Study Area.

In 2009, EPA published the Proposed Plan for the MEW Study Area that identified EPA's preferred alternatives for the vapor intrusion remedy. The Proposed Plan identified the adoption of a municipal ordinance as EPA's preferred IC, but the City of Mountain View and concerned property owners raised concerns that this was not necessary. Instead, EPA worked with the City of Mountain View, California, to have the City formalize its permitting procedures that apply to future construction. These permitting procedures oblige those proposing new building construction within the MEW Study Area to obtain EPA approval of construction plans to ensure that, where necessary, the appropriate vapor intrusion control system is integrated into building construction. In a 2010 ROD Amendment, EPA presented its selected remedy for the vapor intrusion pathway for the MEW Study Area. The ROD Amendment identified a combination of ICs for use at the site. In place of a municipal ordinance as called for in the Proposed Plan, the ROD Amendment selected reliance upon the internally modified permitting procedures by the City of Mountain View's Building, Planning, and Permitting Departments. The City will also implement remedy requirements for projects subject to the California Environmental Quality Act through that law's procedures. With regard to existing commercial buildings where an active remedy is necessary, EPA selected the use of recorded agreements that will help provide notice to current and future owners and occupants, notice to EPA and the MEW Companies when there is a change in building ownership or configuration, and the necessary access to install, maintain and operate the vapor intrusion remedy. These agreements will be binding on and enforceable against future property owners. Additionally, EPA selected the use of a tracking service to provide notice when changes are made to properties within the MEW Study Area. Additional controls that will be implemented by the City of Mountain View include creation of a mapping database to help ensure that parties interested in properties within the MEW Study Area are informed of the appropriate construction specifications when making inquiries with the City.

For more information on the MEW Study Area, see the *Final Supplemental Feasibility Study for the Vapor Intrusion Pathway* (June 2009), *Proposed Plan for the Vapor Intrusion Pathway* (July 2009), and *Record of Decision Amendment for the Vapor Intrusion Pathway* (August 2010), available at: [www.epa.gov/region9/mew](http://www.epa.gov/region9/mew)

outside the authority of EPA that may raise questions regarding the reliability and continued sustainability of the IC. Obtaining early and continued assurances from a local government specifying its commitment to the governmental control is recommended to help address this limitation prior to its selection as part of a final cleanup plan.

Certain IC instruments may not be available for use at a site, depending on federal, state, local, tribal, or other applicable laws. Therefore, after determining the universe of ICs available for use at a particular site, the practical and legal limitations can be evaluated. For example, large sites with widespread contamination pose unique IC challenges. These challenges could arise, for instance, where a contaminated groundwater plume underlies many distinct parcels with multiple property owners/occupants and vapor intrusion is the exposure pathway of concern. Negotiating and implementing proprietary controls with many property owners, some of whom may not be PRPs, may present legal, administrative, and other challenges.<sup>233</sup>

#### 8.6.4 Long-term Stewardship

Long-term stewardship (LTS) activities are intended to help ensure that cleanups remain protective of human health and the environment over time and that reuse activities remain compatible with residual site contamination and associated human health risk potentially posed by the vapor intrusion pathway. LTS procedures vary widely, but they generally are intended to help assure compliance with the response actions at the site, including IC compliance, by providing relevant information in a timely manner to stakeholders who may use the property (e.g., owners, excavators, developers, prospective purchasers or tenants) or to parties who otherwise have IC responsibilities (i.e., an entity with enforcement authority). LTS procedures, for example, may entail provisions to monitor and then inform those responsible for the response actions of potential changes in land use, ownership, tenancy, or building construction at a site. Also, LTS procedures may facilitate monitoring IC(s) so that they remain effective and reliable over time. EPA guidance on ICs generally speaks to LTS procedures in terms of IC maintenance<sup>234</sup> and enforcement activities.<sup>235</sup>

#### *Periodic Reviews*

A key part of IC maintenance is a periodic process over the IC life cycle to critically review and evaluate the IC instrument(s). Site managers and other stakeholders can evaluate the status of IC implementation, maintenance and enforcement activities at a site and address any potential IC deficiencies during the periodic review. The CERCLA FYR process,<sup>236</sup> for example, allows site managers to evaluate overall protectiveness of the remedy, including ICs.<sup>237</sup>

---

<sup>233</sup> See Section 4.4 of the PIME IC Guide for strategies for implementing proprietary controls.

<sup>234</sup> The term “maintenance” generically refers to those activities, such as monitoring and reporting, that ensure ICs are implemented properly and functioning as intended.

<sup>235</sup> See Sections 8 and 9 of the PIME IC Guide discussing IC maintenance and enforcement activities.

<sup>236</sup> See CERCLA section 121(c).

<sup>237</sup> For general FYR guidance, see *Comprehensive Five-Year Review Guidance* (EPA 2001) at [www.epa.gov/superfund/cleanup/postconstruction/5yr.htm](http://www.epa.gov/superfund/cleanup/postconstruction/5yr.htm). For a more detailed discussion on IC considerations during the CERCLA FYR process, see *Recommended Evaluation of Institutional Controls: Supplement to the “Comprehensive Five-Year Review Guidance,”* (EPA 2011c).

A list of possible IC-specific issues arising from any periodic review of a vapor intrusion site may include:

- ICs that are specified by the decision documents but are not yet in place;
- ICs that are in place but are not attaining compliance with the use restrictions specified by the decision documents (e.g., land use not compatible with IC-specified use restrictions);
- ICs are not identified in the decision documents but are necessary for the remedy to be protective of human health because of the vapor intrusion pathway; and
- Response selection assumptions change (e.g., toxicity values, potential exposure pathways, or land uses change) and warrant the need for new or different response actions, including additional IC(s).

### *IC Planning Documents*

Responsibilities to monitor and report on IC compliance, among other obligations, may be documented in an Institutional Controls Implementation and Assurance Plan (ICIAP)<sup>238</sup> or other IC-related planning documents.<sup>239</sup> An ICIAP can serve to: (1) document the activities necessary to implement and ensure the long-term effectiveness and permanence of ICs (that is, the IC life cycle); and (2) identify the person(s) or organization(s) who, under state or local law, are responsible for conducting those activities. Some ICs generally fall within the jurisdiction of a particular category of stakeholders. Therefore, in addition to developing a comprehensive planning document, such as an ICIAP, it may be useful for parties who share IC responsibilities (e.g., a PRP and local government regarding the use of governmental controls, such as an ordinance or permitting system) to reach a common understanding and acknowledge various IC roles and responsibilities in a formalized manner. Where possible, EPA recommends that these types of arrangements among IC stakeholders be documented to describe commonly understood roles and responsibilities for proper and effective monitoring, reporting, and other IC maintenance and enforcement activities.

#### 8.6.5 Community Involvement and ICs

EPA recommends that site managers and site attorneys provide adequate opportunities for public participation (including potentially affected landowners and communities) when considering appropriate use of ICs (EPA 2012e). Those opportunities may include providing appropriate notice and soliciting comments about cleanup plans. Community acceptance of the need for ICs to provide protection from residual contamination and public understanding of the legal and administrative steps for maintaining ICs often are important to the long-term effectiveness of ICs.

---

<sup>238</sup> For further guidance on developing ICIAPs, EPA developed *Institutional Controls: A Guide to Preparing Institutional Control Implementation and Assurance Plans at Contaminated Sites* (EPA 2012e).

<sup>239</sup> For example, other types of documents may address IC-related activities and responsibilities at a site, such as a ROD, O&M plan, and land use control and implementation plan for federal facility sites.

## 8.7 Termination/Exit Strategy

This sub-section focuses on the termination/exit strategy for vapor mitigation response actions. Termination for vapor mitigation activities implemented under CERCLA, RCRA, Brownfields, and federal facilities cleanups can occur when the objectives of these cleanup activities have been met. For purposes of this sub-section, termination refers to the cessation of all activities related to building mitigation, control of subsurface vapor source(s), ICs, and monitoring.

When mitigating vapor intrusion through subsurface source remediation, building mitigation, and ICs, it is important to develop termination criteria, including the rationale for their selection, early in the remedy planning (e.g., alternatives development) process. (Termination criteria generally refer to numeric cleanup levels for each site-specific contaminant and narrative cleanup objectives that are to be attained by the response actions.) EPA recommends that these termination criteria be recorded in decision documents, in any other planning reports, and in monitoring reports. EPA generally recommends also developing and documenting an exit strategy, which clarifies how it will be determined that the termination criteria have been attained (e.g., monitoring data and associated statistics that will be used to demonstrate attainment). This document could be developed in conjunction with the O&M plan and monitoring program so that all stakeholders are provided with a clear and comprehensive set of termination criteria for the remediation and mitigation systems and ICs. If site conditions (e.g., building usage, vapor flux) change during the cleanup activities, it may become necessary to modify the termination criteria and/or strategy.

When reviewing vapor intrusion activities, considerations for evaluating termination activities may include:

- Termination of subsurface remediation activities;
- Termination of engineered exposure controls (building mitigation);
- Termination of the associated ICs; and
- Termination of monitoring.

### 8.7.1 Termination of Subsurface Remediation Activities

Where feasible, the preferred response to address vapor intrusion is to eliminate or substantially reduce the level of volatile chemical contamination in the source media (e.g., groundwater and subsurface soil) to levels that eliminate the need to mitigate or monitor vapor intrusion, as noted in Section 8.1 of this Technical Guide. If subsurface remediation activities are being conducted at the site, termination of these activities will be contingent on demonstrating that the chemical-specific cleanup levels for the subsurface media have been attained. EPA recommends that the termination criteria and exit strategy for these remediation activities be documented to foster collection and evaluation of appropriate data to support eventual termination of these subsurface activities.

EPA recommends that site-specific monitoring data be evaluated to determine if the termination criteria have been met. Typically, monitoring will continue until the source(s) are remediated to cleanup levels that eliminate the need to mitigate vapor intrusion at the point of exposure. As appropriate, the exit strategy may provide criteria for phased remediation, resulting in a

termination evaluation as source cleanup levels are achieved in parts of the contaminated area. If the subsurface vapor source(s) is not remediated, it is generally anticipated that remediation (and monitoring and any building mitigation) will continue.

Monitoring, in part, could be based on data similar to those that were used in a multiple-lines-of-evidence approach for characterizing the pathway and human health risk or for supporting the decision to undertake preemptive mitigation/early action (e.g., soil gas sampling, sub-slab sampling, or vapor sampling within potentially affected structures). EPA recommends identifying and documenting target concentration(s) that would allow for remediation termination, along with recommended monitoring/sampling frequencies.

If evaluation of the site-specific data indicates an increase in subsurface vapor concentrations during the monitoring period, it may be appropriate to evaluate whether the subsurface remediation plan and the CSM are adequate and appropriate.

Typically, once it is preliminarily determined that the subsurface remediation system(s) may be terminated, EPA recommends a period of attainment monitoring. During the attainment period, EPA recommends that the remediation system (e.g., reagent delivery equipment, soil vapor extraction wells) not be operated for a sufficient period to allow subsurface vapors reach equilibrium and indicate post-remediation conditions. The type and frequency of data collected during attainment monitoring entails a site-specific determination. Additionally, EPA recommends that criteria be described and documented, as part of exit strategy development, to determine when ending the attainment monitoring period is appropriate. To develop an exit termination strategy, site-specific fate and transport data may be used to identify an appropriate time period to allow the vapor concentrations to equilibrate. In addition, the termination of the attainment monitoring period may involve an evaluation of the contaminant attenuation in the vadose zone.

### 8.7.2 Termination of Building Mitigation

For purposes of this Technical Guide, “termination of building mitigation” refers to ending the use of an engineered exposure control(s) that reduces or eliminates human exposure via the vapor intrusion pathway. Typically, vapor mitigation is implemented when it is determined that (1) unacceptable human health risk to inhabitants is identified, or (2) the system(s) was(were) installed as part of an early action strategy (see Sections 3.3 and 7.8 for a discussion of building mitigation as an early action).

As described in Section 8.2, vapor intrusion can be mitigated in specific buildings using either an active or passive vapor mitigation system (or a combination thereof).

#### ***Active Building Mitigation***

Generally, building mitigation systems are implemented in conjunction with the investigation and remediation of subsurface vapor source(s). Typically, building mitigation systems will be operated until the source(s) are remediated to attain the cleanup levels (e.g., for the subsurface vapor source(s)) that eliminate the need to mitigate vapor intrusion at the point of exposure. If subsurface vapor source(s) are not remediated, it is generally anticipated that mitigation activities will continue indefinitely. As appropriate, the termination strategy may provide criteria for phased evaluation of system cessation as source cleanup levels are achieved in parts of the contaminated area.

Generally, once the subsurface vapor source(s) is remediated to levels that meet the remedial objectives and protect human health from the vapor intrusion pathway, EPA recommends that the site-specific monitoring data be evaluated to determine if the termination criteria for the building mitigation system have been met. These monitoring data, in part, could be based on data similar to those that were used for characterizing human health risk or for supporting the decision to undertake preemptive mitigation/early action during the vapor intrusion investigation (e.g., sub-slab soil gas sampling and/or indoor air sampling). EPA recommends identifying and documenting target concentration(s) that would allow for system termination, along with recommended monitoring/sampling frequencies. In addition, certain site-specific performance assessment data (e.g., standpipe vapor sampling) may also warrant consideration to make this determination.

Typically, once it is determined that the building mitigation system may be terminated, EPA recommends a period of attainment monitoring. During the attainment period, EPA recommends that the mitigation system (e.g., subslab suction wells or ventilation fans) be offline for a sufficient period to allow vapors beneath the structure reach equilibrium and indicate post-remediation conditions. The type and frequency of data collected during attainment monitoring entails a site-specific determination. Additionally, EPA recommends that criteria be established in the exit strategy to determine when ending the attainment monitoring period is appropriate. To develop an exit termination strategy, site-specific fate and transport data may be used to identify an appropriate time period to allow the vapor concentrations to equilibrate. In addition, the termination of the attainment monitoring period may involve an evaluation of the contaminant attenuation in the vadose zone.

If the attainment criteria evaluation indicates that cleanup levels and objectives are not being met, it may be necessary to continue or resume subsurface remediation and mitigation activities. Once it is determined that the cleanup levels and objectives have been met, the active components of the system may be removed from the building; on the other hand, the building owner may elect to continue to operate the mitigation system under their own discretion and for their own purposes (e.g., radon reduction and moisture control). Once the cleanup levels and objectives have been met, all O&M and monitoring of active mitigation systems specified by EPA can cease.

### ***Passive Building Mitigation***

The termination of passive vapor mitigation systems will typically be similar to the criteria established for the termination of active mitigation systems. In summary:

- Like active mitigation systems, passive mitigation systems are typically implemented in conjunction with the investigation and remediation of subsurface vapor source(s).
- Generally, once the subsurface vapor source(s) is remediated to levels that meet the cleanup levels and objectives that will protect human health from the vapor intrusion pathway, EPA recommends that the site-specific monitoring data be evaluated to determine if the termination criteria have been met.

If the site-specific criteria evaluation indicates that cleanup levels and objectives are not being met, it may be appropriate to evaluate the current system's effectiveness or the possible application of an active mitigation system. Once it is determined that contaminant cleanup levels and objectives have been met, all O&M and monitoring specified by EPA can cease. EPA

generally does not have a need to seek removal of barriers or seals that comprise a passive mitigation system as part of termination activities.

### 8.7.3 Termination of ICs

“Termination of ICs,” as used in this Technical Guide, refers to discontinuing any and all ICs specified by EPA because restrictions on land or resource use and/or notices and other informational devices are no longer necessary to help ensure protectiveness of human health (i.e., human health risk from exposures to vapor intrusion, if any, are expected to be acceptable in the absence of all IC(s)). Generally, ICs are implemented in conjunction with the investigation and remediation of source(s). It is anticipated that ICs selected and implemented will be needed until (1) subsurface vapor source(s) are adequately remediated, or (2) restrictions on land, resource, or building use are no longer necessary based on current and reasonably anticipated future exposure scenarios. Therefore, when developing a termination strategy for ICs that have been selected as part of a response action, the strategy is typically based on data collected from the affected media.

EPA recommends that the exit strategy consider and identify cleanup levels for the subsurface vapor source(s). As long as the subsurface vapor source exceeds such cleanup levels, it is generally anticipated that the associated ICs will continue. As appropriate, the termination/exit strategy may provide criteria for a phased IC termination evaluation as source cleanup levels are achieved in parts of the contaminated area.

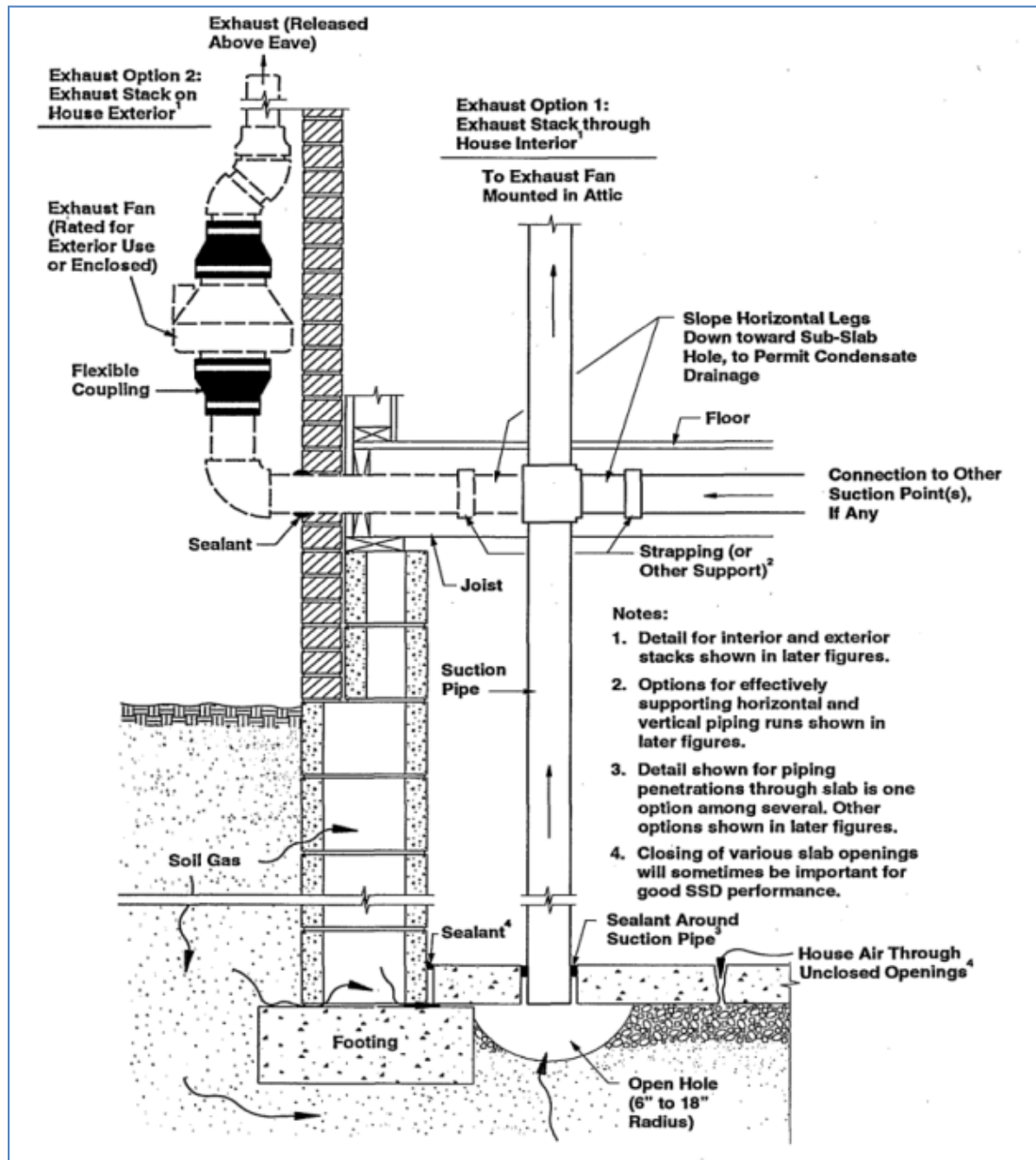
If the site-specific criteria evaluation indicates that terminating the ICs is appropriate, EPA may conclude that site conditions no longer warrant ICs being used as part of the response action for the vapor intrusion pathway. At this point, EPA could notify the appropriate entity(s), such as local or state government, tribe, affected landowner, or responsible parties, in writing that EPA's response objectives have been met and that the IC need not be maintained. As such, EPA's oversight of the IC(s) can cease.

### 8.7.4 Termination of Monitoring

For purposes of this Technical Guide, monitoring includes activities conducted to verify that the vapor intrusion pathway does not pose a health concern to building inhabitants while remediation and mitigation activities are underway and in the event that the remediation and mitigation activities are terminated. “Termination of monitoring,” for purposes of this Technical Guide, refers to ending any monitoring that was needed to verify that no further response action, including IC-related activity, is necessary to protect human health from indoor air exposures posed by vapor intrusion. When developing termination criteria for monitoring, the decision is generally based on data collected from all the affected media.

As noted above, monitoring is generally implemented in conjunction with the remediation of subsurface vapor sources(s). EPA recommends that the exit strategy consider cleanup levels for all contaminated media. Typically, monitoring will continue until the source(s) are remediated to cleanup levels that eliminate the need to mitigate vapor intrusion at the point of exposure (i.e., allow building mitigation systems to be terminated). If the subsurface vapor source is not remediated, it is generally anticipated that any associated monitoring will continue. As appropriate, the exit strategy may provide criteria for phased monitoring, resulting in a termination evaluation as source cleanup levels are achieved in parts of the contaminated area.

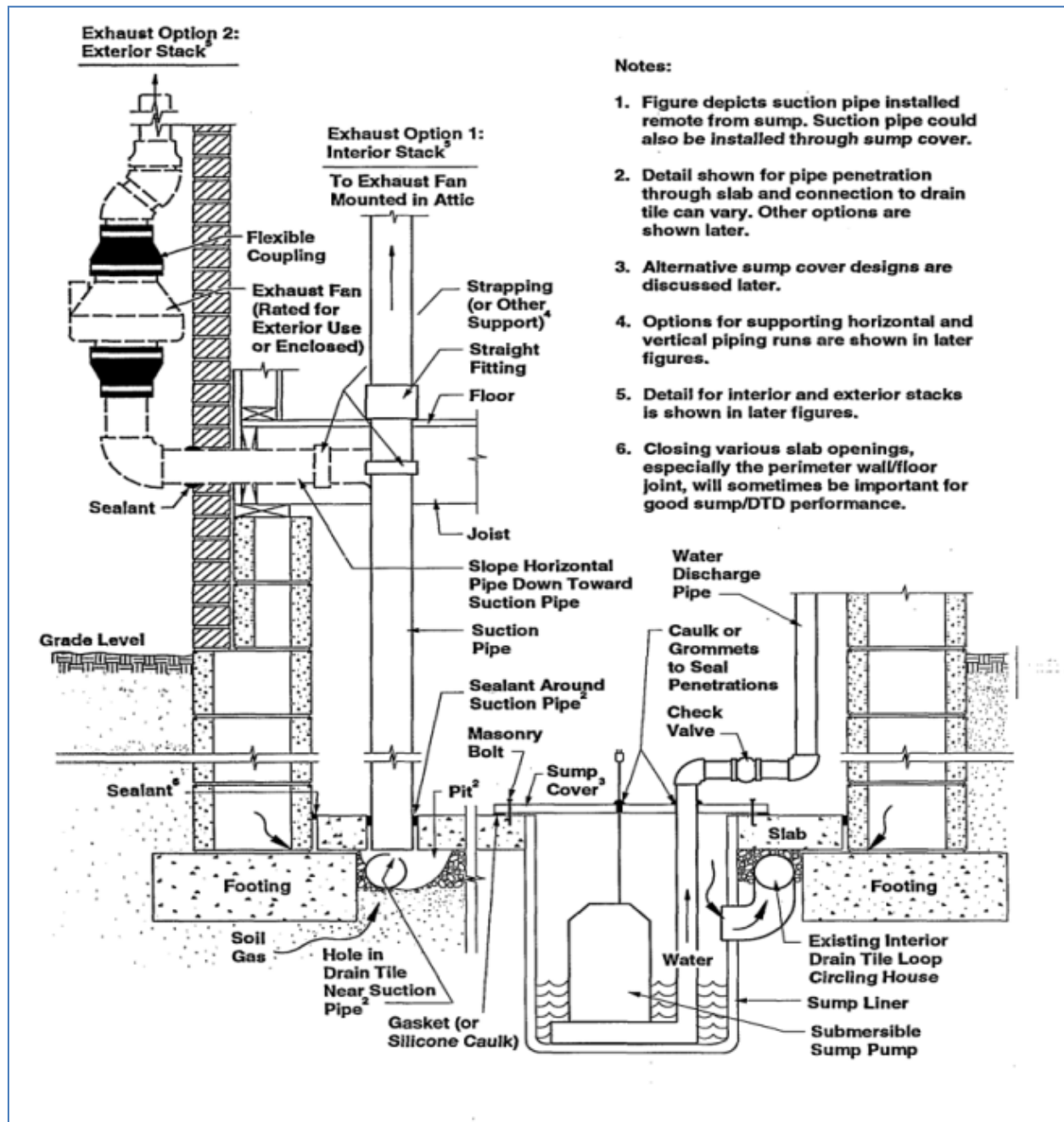




**Figure 8-1 Illustration of Sub-slab Depressurization (SSD) System**

Note: Shows one example of how a sub-slab depressurization system might be constructed. In this case, the example suction pipe has been inserted vertically downward through the slab from inside the house. Two options are indicated for location of the exhaust fan: one exterior to the building; and the other within an attic. In both of these cases, the exhaust gas stream is to be vented outside and above the building.

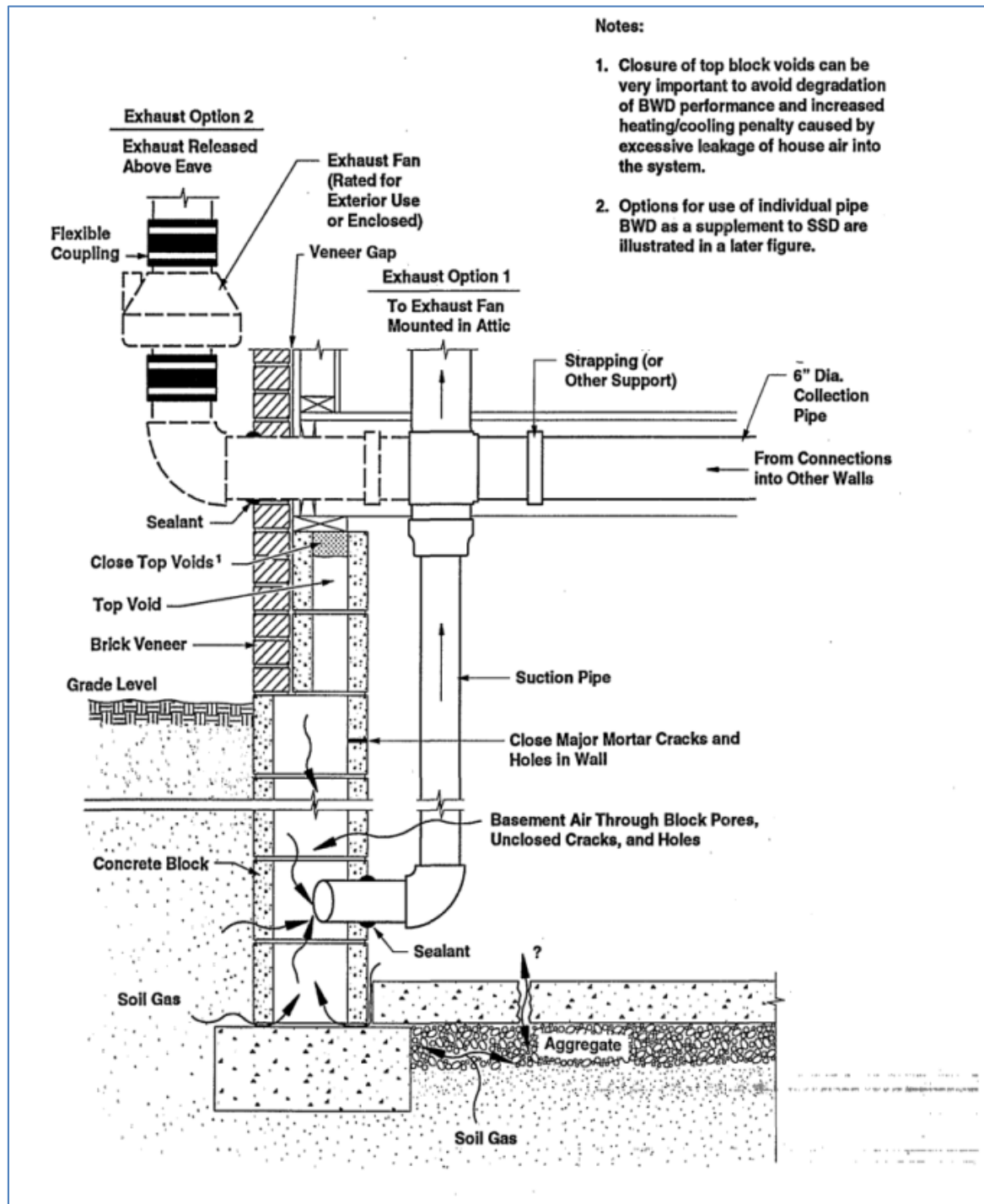
Source: EPA (1993a; Figure 1)



**Figure 8-2 Illustration of Drain-tile Depressurization (DTD) System**

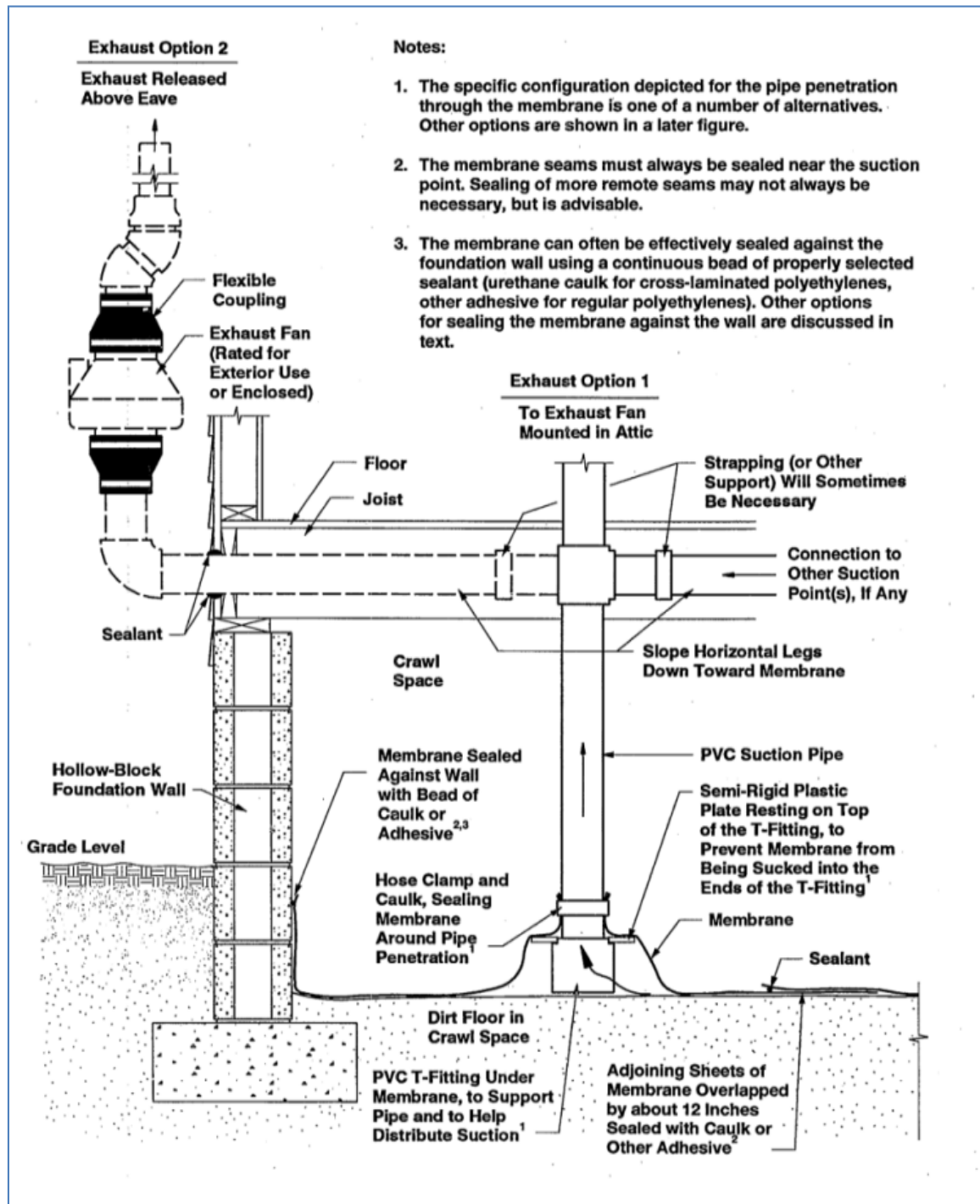
Note: Shows one example of how a drain-tile depressurization system might be constructed. In this case, tiles are shown draining to a sump in the basement, to which an air-tight cover is sealed. The example suction pipe has been inserted vertically downward through the slab at a location remote from the sump. Two options are indicated for location of the exhaust fan: one exterior to the building; and the other within an attic. In both of these cases, the exhaust gas stream is to be vented outside and above the building.

Source: EPA (1993a; Figure 3)



**Figure 8-3 Illustration of Block-wall Depressurization (BWD) System**

Note: Shows one example of how a block-wall depressurization system might be constructed. In this case, individual suction pipes are inserted into the void space in the basement wall, which are connected to one or more fans. Source: EPA (1993a; Figure 5)



**Figure 8-4 Illustration of Sub-membrane Depressurization (SMD) System**

Note: Shows one example of how a sub-membrane depressurization system might be constructed. In this case, the example suction pipe penetrates the membrane overlying a dirt floor.

Source: EPA (1993a; Figure 6)

## 9.0 PLANNING FOR COMMUNITY INVOLVEMENT

Communicating information about environmental risk is one of the most important responsibilities of site managers and community decision-makers. Simply stated, risk communication, whether written, verbal, or visual statements concerning risk, is the process of informing people about potential and perceived hazards to their person, property, or community.

EPA recommends that human health risk be described in context, recognizing there are personal, cultural and societal dimensions of risk. EPA also recommends providing advice about risk-reduction behavior and encouraging a dialogue between the sender and receiver of the message. The best risk communication occurs in contexts in which the participants are informed about risks they are concerned about, the process is fair, and the participants are free and able to solve whatever communication difficulties arise. *Risk Communication in Action: The Risk Communication Workgroup* (EPA 2007) is one of several resources available that explain the elements of successful risk communication and describe communication tools and techniques.

Thus, community involvement is a key component of any site investigation or other EPA response action. Members of the public affected by environmental contamination can be made aware of what EPA is doing in their community and have a say in the decision-making process. Stakeholder and community involvement is particularly important for sites with vapor intrusion issues, in part because the exposure to toxic vapors may pose a significant human health risk that is unknown to inhabitants (in the absence of mitigation systems), as they potentially arise in homes, workplaces, schools, and places of commerce and gathering. Because of the potentially intrusive nature of assessment and mitigation for vapor intrusion, stakeholder involvement is important throughout the process.

EPA generally recommends that stakeholder and community involvement be conducted from the earliest stage of the site assessment and risk assessment process, with on-going education, two-way communication, and discussion throughout the entire process to create community trust and acceptance. For example, EPA recommends initiating community involvement activities as soon as possible after determining that vapor intrusion may exist at a particular site.

Informing the community about vapor intrusion concerns and plans to conduct an assessment, including sampling, can be resource intensive. Thus, EPA recommends evaluating each project, in coordination with appropriate state and tribal officials, to assess the level of stakeholder interest and need for community involvement during various stages of the decision-making process.

### Public Participation and Risk Communication

A meaningful community involvement process is founded upon knowledge of effective public participation and risk communication practices. Public participation refers to the full range of activities that EPA uses to engage communities in the Agency's decision-making process. In 2003, EPA updated its Public Involvement Policy.<sup>240</sup> Its foundation includes seven basic steps to support effective public participation:

---

<sup>240</sup> EPA Public Involvement Policy (2003): <http://www.epa.gov/publicinvolvement/policy2003/index.htm>.

- 1) Plan and budget.
- 2) Identify those to involve.
- 3) Consider providing assistance.
- 4) Provide information.
- 5) Conduct involvement.
- 6) Review and use input and provide feedback to the public.
- 7) Evaluate involvement.

To help implement the steps, EPA developed a series of brochures<sup>241</sup> on effective public participation that outline how to budget for, plan, conduct, and evaluate public participation.

### EPA Program-Specific Community Involvement Guidance and Recommendations

CERCLA and other EPA regulations<sup>242</sup> identify specific community involvement activities that are appropriate at certain points throughout the cleanup process. Specifically, in 2005, OSWER published the *Community Involvement Handbook*<sup>243</sup> (EPA 540-K-05-003). The handbook presents legal and policy motivations for Superfund community involvement and includes additional suggestions for involving the community in the Superfund process. In addition, EPA's *Proposed Guidelines for Brownfields Grants* encourages applicants to describe their plans for involving community-based organizations in site cleanup and reuse decisions.<sup>244</sup> The *Grant Funding Guidelines for State and Tribal Response Programs* for brownfields funding also encourage programs to establish, at a minimum, "mechanisms and resources to provide meaningful opportunities for public participation."<sup>245</sup> In addition, in 1995, EPA promulgated the *RCRA Expanded Public Participation* rule (60 FR 63417-34, December 11, 1995)<sup>246</sup> which created additional opportunities for public involvement in the permitting process and increased access to permitting information.<sup>247</sup>

---

<sup>241</sup> EPA Public Involvement Brochures: <http://www.epa.gov/publicinvolvement/brochures/index.htm>

<sup>242</sup> 40 CFR §300.155 [http://edocket.access.gpo.gov/cfr\\_2003/julqtr/pdf/40cfr300.155.pdf](http://edocket.access.gpo.gov/cfr_2003/julqtr/pdf/40cfr300.155.pdf)

<sup>243</sup> EPA *Superfund Community Involvement Handbook*:  
[http://www.epa.gov/superfund/community/caq/pdfs/ci\\_handbook.pdf](http://www.epa.gov/superfund/community/caq/pdfs/ci_handbook.pdf)

<sup>244</sup> EPA Brownfields Grants website: [http://www.epa.gov/brownfields/cleanup\\_grants.htm](http://www.epa.gov/brownfields/cleanup_grants.htm)

<sup>245</sup> EPA Brownfields State and Tribal Response Program Grants website:  
[http://www.epa.gov/brownfields/state\\_tribal/fund\\_guide.htm](http://www.epa.gov/brownfields/state_tribal/fund_guide.htm)

<sup>246</sup> Section 7004(b) of the Resource Conservation and Recovery Act provides EPA broad authority to encourage and assist public participation in the development, revision, implementation, and enforcement of any regulation, guideline, or program under RCRA.

<sup>247</sup> EPA *RCRA Public Participation Manual*: <http://www.epa.gov/osw/hazard/tsd/permit/pubpart/manual.htm>

At sites with vapor intrusion issues, EPA recommends that the site planning team (i.e., the remedial project manager (RPM) or on-scene coordinator (OSC); community involvement coordinator (CIC); risk assessor; the enforcement case team; EPA contractor; state, tribal, or local agency staff; federal agency staff relevant to the site; or others) to consider the following:

- Develop a community involvement plan (CIP) or update the existing CIP.
- Learn about the site and the community to foster development of a CIP that highlights key community needs, concerns and expectations.
- Commit to ongoing, sustained communication activities throughout vapor mitigation and site cleanup efforts.
- Develop a communication strategy<sup>248</sup> and conduct outreach to inform stakeholders about the facts and findings pertaining to the site.
- Obtain written permission, if appropriate and necessary, for building/property access, and involve the property owner/occupant in identifying or removing potential indoor air contamination sources, including inspection of residence and completing an occupant survey.
- Fully communicate and interpret sampling results, and evaluate mitigation options, if any are warranted.
- Recognize preference of owners and occupants for confidentiality with regards to property-specific data.

When considering the most effective community involvement strategies, EPA recommends that its previous involvement be considered, as well as the existence of community or neighborhood groups and the phase of the regulatory process in which vapor intrusion is being addressed. Additional resources for planning and implementing effective community involvement activities are discussed in Section 9.2: Communication Strategies and Conducting Community Outreach.

### **9.1 Developing a Community Involvement or Public Participation Plan**

A CIP is a site-specific strategy to enable meaningful community involvement throughout the cleanup process.<sup>249</sup> CIPs specify EPA-planned community involvement to address community needs, concerns, and expectations that are identified through community interviews and other means. A CIP will enable community members to understand the ways in which they can participate in decision-making throughout the cleanup process. That is, the CIP is a way for EPA to plan for informing and involving the community in the cleanup process and can be a powerful

---

<sup>248</sup> A communication strategy can be one component of a CIP, but it addresses a specific event, issue, or concern, such as an emergency response to a release, or communicating risk at a site. The CIP, on the other hand, describes an overall strategy for conveying information throughout the cleanup process at a site.

<sup>249</sup> Community involvement plans available at: <http://www.epa.gov/superfund/community/pdfs/toolkit/ciplans.pdf>

way to communicate EPA's commitment to listening and responding to community concerns, and provide timely information and opportunities for community involvement.

The CIP is intended to be a "living" document and is most effective when it is updated or revised as site conditions change. When developing the CIP document, EPA recommends that the site planning team consider the following steps:

#### Describe the Environmental Setting and Cleanup Process

Describe the release and affected areas (the site). This includes information about the site, its history, the key issues related to site contamination, and how vapor intrusion fits into EPA's overall cleanup effort at the site.

#### Describe and Learn about the Community

*Describe the community.* The community profile is a description of the affected community that summarizes demographic information and identifies significant subgroups in the population, languages spoken, and other important characteristics of the affected community, such as whether the site is located in an area with environmental justice concerns or includes sensitive populations. EPA recommends that the community profile also document information sources and describe how the profile was developed.

*Learn about community needs, concerns and expectations:* Issues of concern to residents and business owners can be identified through community interviews, informal discussions and interactions, local media reports, and other insights about the affected community. Questions may include:

- What are public perceptions and opinions of EPA and the cleanup process?
- How do people want to be kept informed (i.e., mechanisms to deliver information)?
- How do people want to be included in the decision-making process?
- What are the perceived barriers to effective public participation?
- Are there other sources of pollution that affect the community?
- Have there been past experiences of mistrust or any unique concerns?

This information can be used to recommend any special services to be provided, including technical assistance, formation of a Community Advisory Group, facilitation/conflict resolution, or translation services.

#### Write and Compile the CIP

Once the site planning team has learned about the community, it is time to put the information together in a way that will be useful to EPA and the community. In addition to the site description, community description, and community needs and concerns, the CIP also may include a reference listing of contacts (name, address, phone, email) useful for the



community or the site planning team. EPA recommends that the contact list generally include contact information for:

- The site planning team.
- Community groups and community leaders.
- Local elected officials.
- Local, state, tribal, and federal agency staff relevant to the site.
- Media contacts (including social media outlets and community journalists).
- Others, as appropriate.

To ensure that the CIP is indeed informed by the community, EPA recommends that a draft of the CIP be shared with the community, and their input and feedback be invited as it evolves. Again, the CIP is intended to be a “living” document and is most effective when it is updated or revised as site conditions change. In some cases, particularly when the CIP is updated or revised for a FYR or where community interest is minimal, a short CIP outlining EPA’s plan for community involvement may be all that is needed. For most sites, EPA recommends that the CIP be written to address the community directly, and their active involvement be invited at each stage of the cleanup process.

## **9.2 Communication Strategies and Conducting Community Outreach**

EPA recommends that community outreach activities be initiated as soon as possible after determining that vapor intrusion may exist at a particular site. Informing and educating the community includes distributing information and providing opportunities for EPA to listen to community concerns. EPA recommends community outreach activities be tailored to the community based on information gleaned from community interviews and other methods used in developing the CIP. Public health officials from state, tribal, or local agencies may be helpful in communicating risk information and answering questions from the community.

### **Communication Strategies**

Communication strategies are plans for communicating information related to a specific issue, event, situation, or audience. They serve as the blueprints for communicating with the public, stakeholders, or even colleagues. EPA recommends that communication strategies:

- Outline the objective and goals of the communication.
- Identify stakeholders.
- Define key messages.
- Pinpoint potential communication methods and vehicles for communicating information and obtaining information from the community for a specific purpose.

When developing a communication strategy, the first step is to determine why the communication is necessary and define its desired objectives, and then to focus on defining the audiences and how to reach them. Keep in mind that the demographics, knowledge, and concerns of the audiences play an important role in defining the key messages. Once the key messages are defined, the outreach vehicle can be determined.

### Conducting Community Outreach

The site planning team likely will use several different outreach techniques during the course of the cleanup process. When planning community outreach, EPA generally recommends that the site planning team collaborate with internal and external partners, such as local, state, and tribal officials and departments of health; faith-based organizations; and community groups. It is important to accommodate hearing-impaired or limited English proficiency (LEP)<sup>250</sup> persons in all outreach efforts by providing spoken or sign language interpreters at meetings and translating printed outreach materials. It also is important to ensure that the community understands the concept of vapor intrusion.

Examples of community outreach techniques to consider are described below.

#### Public Meetings/Gatherings

Public meetings are a useful opportunity to explain environmental conditions at the site, potential health impacts, intended indoor air sampling, and remediation strategies. It may be helpful to hold meetings prior to and following key sampling events to describe sampling strategies and consequent results, respectively. EPA recommends that the meeting include a period to address specific questions from the public regarding sampling results or any other specific concerns, as well as visual aids and maps and spoken or sign language interpreters to facilitate communication and discussion. The use of a CSM, for example, is useful in public meetings to graphically reinforce the messages. It may be helpful to follow up with meeting participants to inquire about the effectiveness of the meeting and whether it met their needs. Other meeting follow-up activities could include responding to requests for information, distributing meeting notes, and creating a mailing list.

Additional opportunities for the site planning team to communicate with the community in a group setting include public availability sessions and public forums or poster sessions at community group meetings or neighborhood board meetings. These options are a more informal way of interacting with community members and they allow a casual “question and answer” or discussion format as compared to the more formal presentation at a public meeting.

#### Mass Media

The media can be the best means of reaching a large audience quickly. Extending invitations to the media for important meetings, providing opportunities for media questions

---

<sup>250</sup> Executive Order 13166, *Improving Access to Services for Persons with Limited English Proficiency*, directs federal agencies to examine the services they provide, identify any need for services to those with LEP, and develop and implement a system to provide those services so LEP persons can have meaningful access to them.

to be addressed in a timely manner, and recognizing that the media control the content of their publications all are important considerations when working with the media. The site planning team can work with the Agency's regional site press officer to foster a relationship with the media by sharing the Agency's rationale for its plans and actions. It is appropriate to use the media to publicize a site-related decision, an upcoming meeting, changes in schedule, or changes in activities or expectations. Press releases can be used to inform the media of major site-related milestones.

### Fact Sheets

Communities appreciate concise, easy-to-understand, and technically accurate fact sheets on the history of the contamination, chemicals of concern, human health risk, planned cleanup activities, and the vapor intrusion assessment and response actions. Be sure to include who to contact for more information.

Because sites involving vapor intrusion can be complex, it may be useful to include additional information in the fact sheets for home owners and renters, including information about household products that may be potential sources of indoor air contamination, as well as steps that can be taken to minimize these sources. EPA recommends preparing and distributing periodic status updates and fact sheets to concerned community members throughout the cleanup process.

### Letters

Whenever there are plans to conduct indoor air sampling, EPA recommends sending a letter to each building owner and renter explaining plans to conduct indoor air sampling and requesting written permission for voluntary access to do so. In addition, a one-on-one meeting with the building owner or renter is generally recommended to discuss sampling efforts and access agreements in detail (see Section 9.3).

EPA also recommends that letters be sent to each building owner and renter to report sampling results in a timely manner (see Section 9.4). These letters and meetings often are part of a larger effort that also includes use of other communication strategies, such as community meetings and in-person visits.

### In-person Visits

EPA recommends individual, one-on-one communication with each property owner and renter whenever possible.

- Try to schedule in-person visits with individual property owners and renters. These visits also may include owners and renters of properties located outside the planned investigation area. The initial visit can be used to explain sampling plans in more detail, answer questions, and obtain written permission to sample.
- During the visit, the property owner or renter can be briefed about any instructions to follow during sampling activities (for example, keep doors and windows closed during sampling). A general survey of the building could be conducted to determine likely sources of indoor air contaminants.

- EPA recommends the site planning team also describe to owners and renters the sampling devices that will be used, what they look like, where they will be located, and any restrictions or impediments to daily activities that may arise from the ongoing sampling activities.

#### Information Repository

An information repository can be established and maintained prior to, during, and following site activities, which is generally required for sites where remedial action or removal actions (where on-site action is expected to exceed 120 days) are undertaken pursuant to CERCLA. The information repository is intended to include the administrative record, fact sheets, question-and-answer sheets, and other site-related documents and be located reasonably near the site. However, given the tremendous change in information technology, it may also be appropriate to set up an Internet-based or digital repository (webpages) to share key information. This depends on the community's ability to access and utilize this technology. EPA recommends that community members be made aware of the information repository through the other public outreach mechanisms described above (e.g., local media, newsletters, and public meetings).

#### Electronic Notification

It also may be useful to establish a registration capability that allows interested community members to sign up for automatic alerts to updates posted on the site website or email listserv.

### **9.3 Addressing Building Access for Sampling and Mitigation**

EPA recommends that all requests for access, as well as provision of access, be in writing in order to document EPA's due diligence to protect human health at the site. EPA recommends that the site planning team provide building owners and occupants with information about the sampling device(s) being used, including what they look like, where they will be located and any restrictions or impediments to daily activities that may arise due to ongoing sampling.

In the case of an initial refusal to provide access, additional attempts for access are generally recommended, although regional practices may vary. EPA recommends documenting all attempts to gain access, for example using telephone conversation records, emails, or letters sent to home or building owners.

Gaining access to owner-occupied residences for vapor intrusion sampling and mitigation may be handled differently than for commercial buildings or rental properties.

Owner-Occupied Residences: Allowing EPA to sample or install mitigation systems in an owner-occupied residence is a voluntary action. EPA generally encourages owners to take advantage of an offer for an assessment and mitigation system, if necessary.

Rental Properties: Access may be voluntary or involuntary. Site planning teams often deal with both owners and renters when there is a need to sample on, in, or under a rental property. There are different legal and communication issues for owners and renters. For example, the owner is responsible for granting access for sampling and for installation of mitigation measures, if they are necessary; however, if the owner grants access, logistics normally are

arranged with the renter. EPA recommends apprising both the owner and the renter of human health risk that may be posed by vapor intrusion, which includes providing building-specific sampling results to both parties when available. If the owner of a rental property refuses access, EPA may, nevertheless, pursue access, in the interest of protecting the occupants, for determining the need for response, choosing a response action, taking a response action, or otherwise enforcing CERCLA or RCRA (EPA 1986, 1987, 2010a). Notifying the owner of a rental property of this statutory authority may help to avoid the need for legal action.

**Nonresidential Buildings:** Site managers also may need to sample on, in, or under nonresidential buildings, such as schools, libraries, hospitals, hotels, and stores. In these situations, broader outreach to the public may be appropriate in addition to maintaining direct contact with the property owner. Similar to rental properties, access for sampling and for implementation of mitigation methods, if they are necessary, may be voluntary or involuntary. If the owner of a nonresidential building refuses access, EPA may, nevertheless, pursue access, in the interest of protecting the occupants, for determining the need for response, choosing a response action, taking a response action, or otherwise enforcing CERCLA or RCRA (EPA 1986, 1987, 2010a).

**Property Ownership Changes:** For owners of homes or buildings who did not provide access for assessment sampling or installation of a mitigation system, EPA recommends that the site planning team make reasonable attempts to track ownership changes, although the appropriate state, tribal, or local agency or PRP may be in a better position to track this information. For example, reasonable attempts to make contact can be done by annually conducting drive-bys or inspections and noting homes or buildings for sale, periodically checking on-line real estate sales or title insurance listings, or using other mechanisms. Homes that were initially targeted but not sampled can be reconsidered during the review or if there are major changes to the toxicity values for the site contaminants of concern. Annually mailing notifications to buildings not previously sampled is a means to foster reconsideration of testing with a change in ownership. If ownership changes are noted, appropriate follow-up can be conducted with the new home owner or building owner.

Federal statutory authority to access private property to conduct investigations, studies and cleanups pursuant to CERCLA and RCRA is discussed in Section 1.2 of this Technical Guide.

## **9.4 Communication of Indoor Sampling Efforts and Results**

The community involvement plan or public participation plan is intended to address community concerns and participation regarding indoor air and sub-slab sampling. In addition to the general community involvement activities occurring throughout the cleanup process (see Section 9.2), the site planning team may choose to hold a community meeting to discuss indoor sampling efforts and results. EPA recommends sending a letter to each home or building owner and renter explaining plans to conduct sampling or providing sampling results. EPA recommends that this letter be in addition to a one-on-one meeting with the building or home owner to discuss access agreements, sampling efforts, and sampling results. Prompt communication of sampling results to building or home owners is important as some people may choose to make precautionary decisions prior to regulatory decisions on remediation or mitigation measures.

EPA recommends the site planning team inquire about stakeholder preferences for confidentiality with regards to property-specific data. It may be appropriate to segregate data for private residential properties versus community properties (e.g., schools, daycare centers,

commercial buildings) or provide different types of property identifiers for these respective building types in reports and maps and tables displayed at public meetings or otherwise made available to the community.

### Letters Transmitting Sampling Results<sup>251</sup>

EPA recommends that the site planning team provide validated sampling results and interpretations (e.g., chemicals of concern, associated risk assessment implications) in plain English (and translations, if necessary) to property owners and renters in a timely manner (e.g., within approximately 30 days of receiving the results). EPA also recommends the transmittal letter indicate what future actions (e.g., mitigation options), if any, are contemplated,<sup>252</sup> based on the sampling results, and contain additional site-specific and possibly building-specific information, including, but not limited to:

- Site and Home/Building Information.
  - Site name and location of contamination.
  - Date of sampling.
  - Address of sampled home or building.
  - Locations sampled (both indoor and outdoor).
  
- Sampling Results
  - Sampling results for site-related, vapor-forming chemical(s) and for any other chemicals, if detected, including an explanation of results believed to be attributable to background sources, if known.<sup>253</sup>
  - Risk-based screening levels (for example, VISLs described in Section 6.5) or other risk-based benchmarks used to explain and interpret the sampling results.
  - Explanation and interpretation of sampling results, if known, which may include a summary of the human health risk assessment, if available (see Section 7.4).<sup>254</sup>

---

<sup>251</sup> Within the community of risk professionals, the phrase 'risk communication' has come to mean communication that supplies lay people with the information they need to make informed independent judgments about human health risk or public safety (Morgan et al. 1992). In this case about vapor intrusion, the ultimate goal of risk communication is to assist stakeholders and the general public in understanding the investigation data and the rationale behind any risk-informed decision, so they may arrive at a balanced judgement that reflects the factual evidence in relation to their own interests and values.

<sup>252</sup> This section may include an explanation of mitigation process and responsibilities and a timeline for further contact regarding system installation and options. If a building mitigation system is recommended on the basis of a human health risk assessment, EPA recommends that the site planning team explain that the risk calculation reflects conservative, health-protective factors.

<sup>253</sup> With such information, EPA can help advise citizens about the environmental and public health threats they face that are within their control (e.g., from indoor sources). In cases where 'background' contamination may pose a human health risk, but its remediation is beyond the authority of the applicable statute, risk communication to the public may be most effective when coordinated with public health agencies (EPA 2002e). The public may also be advised about the scope and limits of EPA's statutory authorities.

<sup>254</sup> Assessment uncertainty is generally an important factor in deciding how to act (Frewer 2004); i.e., whether to reduce risk through response action or reduce uncertainty (e.g., through additional monitoring and data collection). Risk professionals, therefore, generally recommend that risk communication to stakeholders and the general public characterize the sources of uncertainty, as well as the magnitude of uncertainty associated with a particular hazard (see, for example, Frewer (2004) and Markon and Lemyre 2013)).

- Simple tabulated and color-coded results (representing exceedances of human health risk levels or no exceedance).
- **Diagrams/Illustrations**
  - Diagrams and illustrations of sampling devices.
  - Diagrams and illustrations of sampling locations
  - Diagrams of specific mitigation systems (e.g., how a SSD system works and looks).
- **Next Steps**
  - Actions that property owners and occupants can take to reduce vapor intrusion exposure until mitigation systems are in place.
- **Information Sources**
  - Contact information for a person who can answer questions or supply further explanations.
  - The location of the site information repository or site website can be included as a resource for public access to more detailed information and site documents.

## 9.5 Transmitting Messages Regarding Mitigation Systems

The initial notification to residents or building owners about mitigating vapor intrusion can be delivered in various ways. A primary mechanism is a face-to-face meeting with the building owner or occupant to explain the sampling results and discuss next steps, including installation of a vapor intrusion mitigation system. EPA recommends that this meeting include a member of the site planning team (RPM or OSC and risk assessor, for example), a representative from the local health department or the Agency for Toxic Substances and Disease Registry (ATSDR), and the mitigation contractor scheduler. This meeting could discuss topics such as:

- **Sampling Results**: Describe where samples were taken and the chemicals of concern, and explain the results as related to site action levels. Any questions related to human health risk can be answered by the risk assessor or public health representative at this time. For questions or concerns regarding personal health, EPA recommends that residents and building owners contact their medical professional.
- **Mitigation System Details**: Describe the need for a mitigation contractor to visit the residence to identify potential locations for the mitigation system. The property owner will need to be present for the visit and will have input about where the system is installed, if they agree to install such a system. Photos of a mitigation system (piping, system fan, number of holes drilled in the slab, height of the vent on the outside of the residence, etc.) may be helpful. EPA recommends that plans and schedules for periodic inspection, maintenance, and monitoring also be described.
- **Access**: EPA recommends advance planning to ensure building access to install, monitor and maintain any mitigation system. Arrangements could be made at this meeting to sign an additional access agreement for these activities, if needed.
- **Cost of the Mitigation System**: Identify which party will pay for installation of the mitigation system and anticipated property-owner costs. For example, EPA or a PRP may pay for the

system installation, and the property owner or PRP may take responsibility to pay for the monthly costs associated with the mitigation system.

- **Project Schedule and Next Steps:** The meeting may be concluded by giving an overview of the overall project timeline, including the appointment for the mitigation contractor visit and system installation.

Notification also can be provided through the data transmittal letter. In many cases, however, the decision to install mitigation systems will not have been made prior to the transmittal of sampling results. In these situations, data transmittal letters can convey that EPA is reviewing all data results for the affected area and considering appropriate next steps. Once the decision document is signed, the site planning team can develop and mail a fact sheet to all community members in the affected area, followed by a community meeting.

In addition, if a vapor intrusion mitigation system is installed, EPA recommends that the property owner or renter be informed that the system normally is designed to protect the home or building only against vapor-forming chemicals coming from the subsurface. A vapor intrusion mitigation system generally will not protect the home against continuing indoor sources because vapor intrusion mitigation systems typically are not indoor air filtration systems.

EPA recommends that current owner-occupants be advised that if they decline or waive an offer to install a vapor mitigation system, they might be responsible for the costs of installing and maintaining their own system if they decide to do so at a later time. EPA also recommends documenting any declination or waiver.

## 9.6 Addressing Community Involvement at Legacy Sites

Ongoing site activities with assessment components, such as remedial investigations and monitoring, allow EPA to continually evaluate site conditions and adjust cleanup actions as warranted. During periodic reviews or conducting other site activities, such as the FYR pursuant to CERCLA, EPA has evaluated vapor intrusion where appropriate. In some instances, EPA has newly identified vapor intrusion as an exposure pathway. These mature or “legacy” sites present a unique challenge to site planning teams.

Conducting community involvement at legacy sites may be complicated by several factors including:

- A remedy for the control of exposure to volatile chemicals already has been installed, proposed, or is under construction as part of the cleanup plan.
- Ownership of properties previously exposed to VOCs has changed hands through resale, foreclosure, or assumption of the property by second-generation homeowners. These owners were not part of any original resolution of exposure issues and in many cases may not be aware that a remediation or treatment was put in place.
- Property owners and other community members who participated in prior cleanup efforts may be reluctant to fully engage with efforts to reopen lines of investigation at their properties.



In these and similar circumstances, the challenge for Agency representatives is to resume contact with communities who have put past difficulties behind them. In many cases, mailing lists are outdated, previous reliable contacts no longer are available, and elected officials may not have institutional memory of the events that prompted the remediation.

### Strategies for Revitalizing Community Involvement at Legacy Sites

Every legacy re-entry will be a site-specific situation. Therefore, EPA recommends that events and activities be planned to acknowledge and accommodate the inevitable changes in the makeup of a community. In addition to the communication strategies and community involvement techniques described in Sections 9.1 through 9.5, additional suggestions to ease re-entry and revitalize community involvement at a legacy site include:

- Reassess the community and the site by revisiting the site and the surrounding areas and taking note of new construction.
- Reintroduce yourself and the Agency to current municipal staff and check previously used public venues for viability. Determine if new venues may be closer or more accessible to the community.
- If contacts within the community are still extant, reconnect; ask for updates on the growth and stability of the community. If no viable contacts exist, attempt to cultivate new ones.
- Revise and update mailing lists and fact sheets.

As with all sites affected by vapor intrusion issues, be prepared to meet with property owners door to door and to hold public meetings or forums to explain the current investigation and its importance to protecting human health.

## **9.7 Property Value Concerns for Current and Prospective Property Owners**

EPA recognizes that vapor intrusion impacts may have implications for property values. In some instances, mitigation systems and other clean-up measures may help to restore property values.

Nevertheless, property value issues are outside the scope of Agency authority. In general, if asked, EPA recommends that regional staff suggest that prospective buyers and sellers contact real estate professionals and lenders from the local area with questions about property values. If a home owner or renter has questions about vapor intrusion mitigation systems, EPA regions can provide information that explains how vapor intrusion systems are designed to reduce exposure to chemicals found in indoor air and to avert human health-related problems.

## **9.8 Additional Community Involvement Resources**

EPA's Superfund Community Involvement Program:

EPA's Superfund Community Involvement website contains many resources that may be helpful for planning community involvement activities for other cleanup programs. This resource includes a list of regional Superfund community involvement points of contact, a list of technical

assistance and training resources, and descriptions and links to community involvement policies, guidance and publications (see <http://www.epa.gov/superfund/community/>).

EPA's Superfund Community Involvement Toolkit (CI Toolkit):

While targeted to a Superfund Program audience, the CI toolkit may be helpful to a wide variety of users because it is a practical, easy-to-use aid for designing and enhancing community involvement activities and contains tips on how to avoid some of the pitfalls common to the community involvement process. The toolkit enables users to quickly review and adapt a variety of community involvement tools to engage the community during all stages of the cleanup process. Relevant tools include tips for conducting public availability and poster sessions and public meetings, developing fact sheets, working with the media, planning communication strategies, developing a Community Involvement Plan, and establishing an information repository (see <http://www.epa.gov/superfund/community/toolkit.htm>).

EPA's Community Engagement Initiative:

The OSWER CEI is designed to enhance OSWER and regional offices' engagement with local communities and stakeholders to help them participate meaningfully in government decisions on land cleanup, emergency preparedness and response, and the management of hazardous substances and waste (see <http://www.epa.gov/oswer/engagementinitiative/>).

## 10.0 GLOSSARY

The following definitions are provided for purposes of this Technical Guide:

accumulate .....	Increase gradually in amount as time passes. Note that there will be a finite maximum amount, which will be determined by site- and building-specific conditions and will reflect a balance among physical processes (e.g., soil gas entry, air exchange).
active.....	Involving mechanical operations; Compare with <i>passive</i> .
active depressurization technology.....	Vapor intrusion mitigation method that creates a driving force for air flow from the building into the subsurface by lowering the pressure below the slab, thereby reducing vapor intrusion (soil gas entry into a building).
acute .....	Refers to repeated or single exposure for 24 hours duration or less. Compare with <i>short-term</i> and <i>subchronic</i> .
advection.....	As it pertains to soil gas, refers to bulk movement in the vadose zone induced by spatial differences in soil gas pressure. The direction of advective vapor transport is always toward the direction of lower air pressure.
aerobic .....	Describes a process or activity requiring oxygen. Compare with <i>anaerobic</i> .
air exchange rate .....	Rate of air infiltration into a building through windows, doorways, intakes and exhausts, 'adventitious openings' (e.g., cracks and seams that combine to form the building envelope), plus natural and mechanical ventilation.
ambient air.....	The outdoor air surrounding a building or site.
anaerobic .....	Describes a process or activity requiring the absence of oxygen. Compare with <i>aerobic</i> .
analyte.....	A substance for which identification (of presence) and/or quantification (of amount, such as concentration) is/are sought by instrumental measurement.
attenuation .....	Decrease in vapor concentration in soil gas emanating from a subsurface vapor source along the migration route towards and into a building (indoor air)
attenuation factor.....	The ratio of the indoor air concentration arising from vapor intrusion to the soil gas concentration at the source or a depth of interest in the vapor migration route.
background .....	Refers to a vapor-forming chemical(s) or location(s) that is(are) not influenced by the releases from a site, and is usually described (EPA 1989, 1995c, 2002e) as naturally occurring or anthropogenic: 1) <i>Anthropogenic</i> – natural

- and human-made substances present in the environment as a result of human activities and not specifically related to the site-related release in question; and, 2) *Naturally occurring* – substances present in the environment in forms that have not been influenced by human activity. Background may include a vapor-forming chemical(s) present in indoor air due to human activities that is(are) not related to vapor intrusion or site-related contamination.
- background vapor concentration ..... This term may include the concentration of a vapor-forming chemical in indoor air that fits within the definition of “background” above. Information on background concentrations of vapor-forming chemicals in indoor air “is important to risk managers because generally EPA does not clean up to concentrations below natural or anthropogenic background levels” (EPA 2002e).<sup>255</sup>
- background vapor source..... The origin(s) and location(s) of a vapor-forming chemical(s), other than vapor intrusion, and not associated with or emanating from a site-related release(s) to the environment. Background vapor sources may include indoor or outdoor sources. See also *indoor vapor source*, *outdoor vapor source*, and *background vapor concentration*; compare to *subsurface vapor source*.
- biodegradation..... Decomposition or breakdown of a substance through the action of microorganisms (such as bacteria or fungi).
- brownfield ..... A parcel of real estate that is abandoned or inactive or may not be operated at its fully beneficial use and on which expansion or redevelopment is contemplated or reasonably expected; distinguished from “greenfield” because expansion or redevelopment may be complicated by the presence of vapor-forming chemicals in the subsurface environment.
- building..... a structure that is intended for human occupancy and use. This would include, for instance, homes, offices, stores, commercial and industrial buildings, etc., but would not normally include sheds, carports, pump houses, or other structures that are not intended for human occupancy.
- building survey..... Refers generically to gathering -- by observation, interviews, reviewing documents and records or other means -- information about existing buildings, including,

---

<sup>255</sup> It should, however, be noted that some EPA regulations (e.g., indoor radon standards under 40 CFR 192.12) are inclusive of background.

---

	but not limited to, location, use, occupancy, basic construction (e.g., foundation type), heating ventilation and cooling systems, potential indoor sources of vapor-forming chemicals, and anticipated susceptibility to soil gas entry (e.g., presence of radon mitigation system).
capillary fringe .....	The porous material just above the ground water table which may hold water by capillarity (a property of surface tension that draws water upwards) in the smaller void spaces.
chlorinated hydrocarbon (CHC) .....	Compound comprised solely of the elements chlorine, hydrogen and carbon. Includes dry-cleaning solvents such as tetrachloroethylene (PCE) and degreasing solvents such as trichloroethylene (TCE) and 1,1,1-trichloroethane (TCA).
chronic.....	Refers to repeated exposure for more than approximately 10% of the life span (approximately seven years) in humans. Compare with <i>subchronic</i> .
concentration.....	Amount (mass) of a vapor-forming chemical contained in a unit quantity (e.g., volume) of a specific medium (e.g., air, soil gas).
conceptual site model (CSM).....	Narrative description of the current understanding of the site-specific conditions, which, in the case of vapor intrusion, include the nature, location, and spatial extent of the source(s) of vapor-forming chemicals in the subsurface and the location, use, occupancy, and basic construction of existing buildings. A CSM represents an adaptation of a general <i>conceptual model</i> to account for and reflect site- and/or building-specific conditions. See also <i>model</i> .
crawl space.....	A type of basement in which one cannot stand up — the height may be as little as one foot, and the bottom surface is often bare soil.
complete (vapor intrusion) pathway .....	The vapor intrusion pathway is referred to as “complete” for a building or collection of buildings when five conditions are met under current conditions: (1) a subsurface source of vapor-forming chemicals is present underneath or near the building(s); (2) vapors form and have a route along which to migrate (be transported) toward the building(s); (3) the building(s) is (or are) susceptible to soil gas entry, which means openings exist for the vapors to enter the building(s) and driving forces exist to draw the vapors from the subsurface into the building(s); (4) one or more vapor-forming chemicals comprising the subsurface vapor source(s) is (or are) present in the indoor environment; and (5) the building(s)

---

	is (or are) occupied by one or more individuals when the vapor-forming chemical(s) is (or are) present indoors.
data objectivity .....	Refers to the accuracy, reliability, and absence of bias in the information; scientific information will generally attain this criterion when the original or supporting data are generated using sound research, investigatory, or statistical methods.
data quality objective (DQO) .....	Performance and acceptance criteria that clarify study objectives, define the appropriate type of data, and specify tolerable levels of potential decision errors that will be used as the basis for establishing the quality and quantity of data needed to support decisions.
data utility .....	Refers to the usefulness (e.g., relevance, importance) of the information to reaching a conclusion or judgment (e.g., is the vapor intrusion pathway complete or incomplete? Does the vapor-forming chemical in indoor air arise from background sources or vapor intrusion? Does vapor intrusion pose an unacceptable human health risk in a specific building?)
diffusion .....	Random motion that affects the distribution of molecules when there are spatial differences in chemical concentrations in the fluid (e.g., soil gas, indoor air, groundwater). The net direction of diffusive transport is toward the direction of lower concentrations.
driving force .....	refers to the combination of: (i) pressure differences between a building interior and the subsurface or ambient air, which foster vapor intrusion and infiltration, respectively, via advection; and (ii) concentration differences between a building interior and the subsurface or ambient air, which foster vapor transport via diffusion.
early action .....	Refers to a response action undertaken early in the cleanup process to achieve prompt risk reduction. Also see <i>response action</i> and <i>pre-emptive mitigation</i> .
evidence .....	A fact or other information (i.e., datum) ascertainable by direct observation, interviews, review of records and documents, instrumental analysis in a lab or field setting, research and testing, sampling of environmental media (e.g., indoor air, soil gas, groundwater), statistical analysis, or other means, which is useful for forming a conclusion or judgment; each distinguishable datum is referred to as a line of evidence, which may be categorized into scientific realms (e.g., geology, biology, physics) or investigatory objectives (e.g., characterization of subsurface vapor source, accounting for background sources)

---

exposure.....	Opportunity to come into contact with vapor-forming chemicals (via inhalation, in the case of vapor intrusion).
exposure assessment .....	Process of characterizing the magnitude, frequency, and duration of exposure to a vapor-forming chemical, along with the characteristics of the population exposed.
exposure control .....	Modification of a property or building intended to reduce or eliminate human exposure to hazardous vapors in buildings or explosive vapors in structures, which arise from the vapor intrusion; such controls may include engineered methods (e.g., active depressurization technologies, mechanical ventilation, indoor air treatment) or non-engineered methods (e.g., institutional controls, such as deed notices and land use restrictions)
exposure pathway.....	The physical course a vapor-forming chemical takes from its source (e.g., groundwater) to the individual (in a building in the case of vapor intrusion).
exposure route.....	The way in which a vapor-forming chemical enters a human body (i.e., inhalation in the case of vapor intrusion).
flux .....	The rate of movement of mass through a unit cross-sectional area per unit time in response to a concentration gradient or a driving force for advection.
gas .....	A fluid (as air) that has neither independent shape nor volume but tends to expand indefinitely; a state of matter in which the matter concerned occupies the whole of its container irrespective of its quantity.
grab sample.....	A sample of air collected over a short (practically instantaneous) duration. Compare with <i>time-integrated sample</i> .
hazard index (HI).....	The sum of hazard quotients for substances that affect the same target organ or organ system. Because different pollutants can cause similar adverse health effects, it is often appropriate to combine hazard quotients associated with different substances.
hazard quotient (HQ).....	The ratio of the potential exposure to the substance and the level at which no adverse effects are expected. If the HQ is calculated to be equal to or less than 1, then no adverse health effects are expected as a result of exposure. If the HQ is greater than 1, then adverse health effects are possible.
hazardous.....	Involving or exposing one to threat of adverse health effects (due to toxicity) or loss of loss of life or welfare (due to explosiveness).

---

Henry's Law Coefficient or Constant...	Ratio of a chemical's vapor pressure in air to its solubility in water. Generally reported for standard reference temperature, such as 25 °C.
human exposure pathway .....	A way that people may come into contact with environmental contaminants while performing their day-to-day indoor activities.
human health risk assessment .....	The evaluation of scientific information on the hazardous properties of vapor-forming chemicals (hazard assessment and characterization), the dose-response relationship, and the extent of human exposure to those agents. The product of the risk assessment is a statement regarding the probability that populations or individuals so exposed will be harmed and to what degree and describing the principal technical uncertainties (i.e., risk characterization).
hydrocarbon .....	Compound comprised solely of the elements hydrogen and carbon. See also <i>chlorinated hydrocarbon</i> and <i>petroleum hydrocarbon</i> .
inclusion zone .....	Land area within which EPA recommends assessing the vapor intrusion pathway, which extends beyond the aggregate boundaries of the site-specific source(s) of vapor-forming chemicals.
indoor vapor source .....	Refers to a vapor-forming chemical(s) in indoor air which originates within a building. Indoor sources of vapor-forming chemicals may include, but are not limited to, use and storage of consumer or household products, use or storage of industrial materials or products, combustion processes, activities or operations within a building, and releases from interior building materials (e.g., off-gases from furniture or clothing); for example, operational use or storage of chemicals in an industrial building may represent an indoor vapor source separate from a site-related release. Also see <i>background vapor source</i> ; compare to <i>subsurface vapor source</i> .
infiltration .....	Air leakage into a building through random cracks, interstices, and other unintentional openings in the building envelope.
institutional control (IC) .....	Non-engineering measures intended to affect human activities in such a way as to prevent or reduce exposure to hazardous substances. For example, ICs may be used to restrict certain land uses, buildings, or activities that could otherwise result in unacceptable exposure to the vapor intrusion pathway. Generally, four categories of ICs are recognized: governmental controls; proprietary controls; enforcement tools; and informational devices. They are almost always used in conjunction with, or as a



---

	supplement to, other cleanup measures such as treatment or containment.
interim action .....	Refers to a response action that is undertaken to protect human health, but is limited in scope and objective (e.g., does not accomplish complete or final remediation of subsurface vapor sources). Also see <i>response action</i> .
interzonal air flow .....	Movement or transport of air through doorways, ductwork, and service chaseways that interconnect rooms or zones within a building.
lines of evidence .....	Data collected and weighed together in supporting assessments of the vapor intrusion pathway, which are identified and described throughout Sections 2 through 7 inclusive. See also <i>evidence</i> .
lower explosive limit (LEL) .....	The lowest concentration at which a gas or vapor is flammable or explosive at ambient conditions.
mitigation .....	Interim actions taken to reduce or eliminate human exposure to vapor-forming chemicals in a specific building arising from the vapor intrusion pathway; compare with <i>remediation</i> .
model.....	Refers to a description of a system. In the case of vapor intrusion the 'system' will generally consist of a subsurface source of vapors, one or more buildings potentially subject to soil gas entry, and the soil underlying the building(s). <i>Conceptual models</i> (i.e., models that are conceptual) are comprised of narrative descriptions that identify the primary physical elements and processes of the system and the interactions between and relationships among them; for example, Section 2 of this document provides a general conceptual model of how vapor intrusion can arise and why it may be variable over time and in space. A <i>mathematical model</i> is an expression of a conceptual model, which uses mathematical symbols and language to identify key elements (e.g., variables) and processes. Generally, mathematical models are highly idealized or simplified descriptions, compared to the complex systems they represent. For example, Johnson and Ettinger (1991) formulated an idealized mathematical model of vapor intrusion. In the case of a <i>physical model</i> , the description is provided using physical objects, which may or may not have full functionality; for example, a physical model of a construction project might differ from a planned system in its scale, but would necessarily show significant elements in relationship to each other.

- near-source ..... Refers to a soil gas sample collected within a practically short distance from subsurface vapor source
- nonresidential building ..... Refers to a building other than a home; includes, but is not limited to, institutional buildings (e.g., schools, libraries, hospitals, community centers and other enclosed structures for gathering, gyms and other enclosed structures for recreation); commercial buildings (e.g., hotels, office buildings, many (but not all) day care centers, and retail establishments); and industrial buildings where vapor-forming chemicals may or may not be routinely used or stored. Compare with *residential building*; see also *building*.
- outdoor vapor source ..... Refers to a vapor-forming chemical(s) present in outdoor (ambient) air. Sources of vapor-forming chemicals in outdoor air may include, but are not limited to, releases from industrial facilities, vehicle exhaust, yard maintenance equipment, fuel storage tanks, paint or pesticide applications, agricultural activities, and fires, as well as site-related contamination, activities, and operations (e.g., emissions from remediation equipment). Also see *background vapor source*; compare to *subsurface vapor source*.
- passive ..... Not involving mechanical operations; Compare with *active*.
- petroleum hydrocarbon (PHC) ..... Hydrocarbons derived from petroleum and present in various refined products of petroleum (such as automotive gasoline, diesel fuel, lubricating oils). See also *hydrocarbon*.
- potentially complete (vapor intrusion .. pathway) ..... The vapor intrusion pathway is referred to as 'potentially complete' for a building when: a subsurface source of vapor-forming chemicals is present underneath or near an existing building or a building that is reasonably expected to be constructed in the future; vapors can form from this source(s) and have a route along which to migrate (be transported) toward the building; and three additional conditions are reasonably expected to all be met in the future, which may not all be met currently (i.e., the building is susceptible to soil gas entry, which means openings exist for the vapors to enter the building and driving forces exist to draw the vapors from the subsurface through the openings into the building; one or more vapor-forming chemicals comprising the subsurface vapor source(s) is (or will be) present in the indoor environment; and the building is or will be occupied by one or more individuals when the vapor-forming chemical(s) is (or are) present indoors.

---

preemptive mitigation (PEM) .....	Implementation of systems or control measures to mitigate the vapor intrusion pathway as an early action, even though all pertinent lines of evidence have not yet been completely developed to characterize the vapor intrusion pathway for the subject building(s). Also see <i>early action</i> and <i>response action</i> .
preferential migration route .....	Naturally occurring subsurface feature (e.g., gravel lens, fractured rock) or anthropogenic (human-made) subsurface conduit (e.g., utility corridor or vault, subsurface drain) that is expected to exhibit little resistance to vapor flow in the vadose zone (i.e., exhibits a relatively high gas permeability) or groundwater flow (i.e., effectively exhibits a relatively high hydraulic conductivity), depending upon its location and orientation relative to the water table and ground surface, thereby facilitating the migration of vapor-forming chemicals in the subsurface and towards or into buildings
pressure difference/differential pressure .....	Difference between the air pressure within a building and the subsurface environment or ambient air. Can promote advective flow of gas into or out of a building through pores, cracks, or openings in the building foundation or envelope.
radon.....	A radioactive gas formed during the radioactive decay of radium, which occurs naturally in many geologic settings.
reasonable maximum exposure (RME) .....	A semi-quantitative term, referring to the lower portion of the high end of the exposure distribution; conceptually, above the 90 <sup>th</sup> percentile exposure but less than the 98 <sup>th</sup> percentile exposure.
reasonable worst case .....	A semi-quantitative term, referring to the upper portion of the high end of the exposure distribution, but less than the absolute maximum exposure.
reference concentration (RfC) .....	An estimate of the continuous inhalation exposure to the human population (including sensitive subgroups) that is likely to be without appreciable risk of deleterious effects during a lifetime.
remediation.....	Refers to interim and final cleanups, whether conducted pursuant to RCRA corrective action, the CERCLA removal or remedial programs, or using EPA brownfield grant funds with oversight by state and tribal response programs. In addition to permanent remedies for subsurface vapor sources, site remediation may also entail implementation of institutional controls and construction and operation of engineered systems.

---

residential building .....	refers to a building used as or intended for use as a home; includes, but is not limited to, single-family detached homes with foundations, trailer homes, multi-unit apartments and condominiums. Compare with <i>non-residential building</i> ; see also <i>building</i> .
response action .....	any action taken to reduce or eliminate human exposure to or risk posed by hazardous vapors in buildings and structures, which arise from the vapor intrusion pathway; these actions may include engineered exposure controls in a specific building(s), non-engineered exposure controls, remediation of subsurface vapor sources, and associated monitoring to assess effectiveness and protectiveness. Also see <i>remediation</i> and <i>mitigation</i> .
risk.....	Probability of an adverse human health effect (due to toxicity) or physical hazard (e.g., due to potential for explosion) caused under specific circumstances by a vapor-forming chemical.
risk communication .....	The process of exchanging information about health threats and levels or significance of human health risk.
risk management .....	The process of determining whether response action(s) is(are) warranted to protect human health and, if so, selecting response actions to implement.
screening.....	Process of comparing concentrations of vapor-forming chemicals in a specific medium (e.g., indoor air, soil gas, crawl space air, groundwater) to screening levels to identify sites, buildings, or chemicals unlikely to pose a health concern through the vapor intrusion pathway versus those warranting further investigation or analysis.
screening level.....	Risk-based concentrations derived from standardized equations combining exposure information and assumptions with toxicity values.
short-term.....	Refers to repeated exposure for more than 24 hours, up to 30 days. Compare with <i>acute</i> and <i>subchronic</i> .
significant opening .....	Refers to refer to an atypical form and amount of an opening in a building (e.g., a sump, an unlined crawl space, an earthen floor), which could facilitate greater amounts of soil gas entry, all else being equal. Forms of openings typically expected to be present in all buildings include cracks, seams, interstices, and gaps in basement floors and walls or foundations and perforations due to utility conduits.
site.....	The geographical area where investigation and evaluation of the presence of vapor-forming chemicals is desired; in many situations, it includes areas surrounding

---

	a facility where a release to the subsurface environment is known or suspected to have originated.
soil gas .....	The gas present underground in the pore spaces between soil particles.
soil gas concentration .....	Vapor concentration in a soil gas sample. Sub-slab soil gas is found immediately beneath a building. Near-source or exterior soil gas samples are collected at other depths and typically outside the building footprint.
source strength.....	Vapor concentration(s) of vapor-forming chemical(s) arising from a subsurface vapor source.
stakeholder.....	A person, group, community, or corporate entity with an interest in activities at a site with subsurface contamination.
subchronic .....	Refers to repeated exposure for more than 30 days, up to approximately 10% of the life span (approximately seven years) in humans. Compare with <i>short-term</i> and <i>chronic</i> .
subsurface remediation.....	Response action that eliminates or substantially reduces the level of vapor-forming chemicals in the subsurface vapor source via treatment or physical removal. Compare with <i>mitigation</i> .
subsurface vapor source.....	Refers to a vapor-forming chemical(s) present in the subsurface environment arising from a release(s) to the environment. A subsurface vapor source may occur as a non-aqueous-phase liquid (NAPL), adsorbed-phase contamination, or dissolved-phase contamination, which may be present in the vadose zone, in groundwater, or within sewers and other conduits. Information on subsurface vapor sources is important to risk managers because response actions are generally warranted when vapor intrusion is determined to pose unacceptable human health risks. Compare with <i>background vapor source</i> and <i>background vapor concentration</i> .
termination criteria .....	Refers to numeric cleanup levels for each site-specific contaminant and narrative cleanup objectives that are to be attained by the response actions.
time-integrated sample .....	Sample collected over an extended period of time to account for temporal variations in vapor concentrations. Compare with <i>grab sample</i> .
toxicity value .....	Refers to an inhalation unit risk (IUR) for potential cancer effects or an inhalation reference concentration (RfC) for potential non-cancer effects of a vapor-forming chemical.

---

vadose zone .....	The soil zone between land surface and the groundwater table within which the moisture content is less than saturation (except in the capillary fringe). Soil pore spaces not occupied by moisture contain (soil) gas. Also referred to as the “unsaturated zone.”
vapor .....	A substance in the gaseous state as distinguished from the liquid or solid state.
vapor intrusion .....	The migration of potentially hazardous vapors from any subsurface contaminant source, such as contaminated soil or groundwater, through the vadose zone and into a building or structure.
vapor source.....	The place and form of origin of chemical vapors. Also see <i>background vapor source, indoor vapor source, outdoor vapor source, and subsurface vapor source.</i>
vapor-forming chemical.....	A volatile chemical that EPA recommends be routinely evaluated during a site-specific vapor intrusion assessment, when it is present as a subsurface contaminant.
volatile chemical.....	Chemical with a vapor pressure greater than 1 millimeter of mercury (mm Hg), or Henry’s law constant greater than $10^{-5}$ atmosphere-meter cubed per mole.
volatility.....	The tendency of a substance to form vapors, which are molecules in a gaseous state, and escape from a liquid or solid source. This tendency is directly related to a substance’s vapor pressure and Henry’s law constant and is indirectly related to a substance’s molecular weight (i.e., substances with lower molecular weights tend to volatilize more readily than substances with similar molecular structures that have higher molecular weights).
water table .....	The water surface in an unconfined aquifer at which the fluid pressure in the pore spaces is at soil gas pressure.
weight of evidence .....	Refers to a conceptual approach to data evaluation, in which each of several lines of evidence is critically appraised for its quality (e.g., utility, objectivity) and systematically assessed for its logical support for a particular conclusion, as well as alternative conclusions; the appraisals consider lines of evidence individually and in light of other lines of reliable evidence for purposes of determining whether a particular conclusion is supported by the preponderance of the evidence and is consistent with the conceptual site model; this ‘weighing’ concept does not entail a quantitative ( <i>a priori</i> ) scheme to score or rank the individual lines of evidence. See also <i>evidence</i> .

- work plan ..... A site-specific document that includes a project description, project objective(s), historical information about the site.
- worst case ..... A semi-quantitative term, referring to the absolute maximum plausible exposure (i.e., a bounding – high-impact – case).

## 11.0 CITATIONS AND REFERENCES

Agency for Toxic Substances and Disease Registry (ATSDR). 2008. *Evaluating Vapor Intrusion Pathways at Hazardous Waste Sites*. Currently available online at: [http://www.atsdr.cdc.gov/document/evaluating\\_vapor\\_intrusion.pdf](http://www.atsdr.cdc.gov/document/evaluating_vapor_intrusion.pdf)

American Society for Testing and Materials (ASTM). 1995. *E 1739: Standard Guide for Risk-Based Corrective Action Applied at Petroleum Release Sites*.

ASTM International. 2003. *E 2121: Standard Practice for Installing Radon Mitigation Systems in Existing Low-Rise Residential Buildings*.

Association of State and Territorial Solid Waste Management Officials (ASTSWMO). 2009. *Vapor Intrusion Pathway: A Guide for State and Territorial Federal Facilities Managers*. ASTSWMO Policy and Technology Focus Group, Washington, D.C. July.

Brenner, D. 2010. Results of a Long-Term Study of Vapor Intrusion at Four Large Buildings at the NASA Ames Research Center. *J. Air & Waste Manage. Assoc.* 60: 747–758.

California Environmental Protection Agency (CalEPA). 2011. *Vapor Intrusion Mitigation Advisory*. Department of Toxic Substances Control. Revision 1. October. Currently available online at: [http://www.dtsc.ca.gov/AssessingRisk/upload/Final\\_VIG\\_Oct\\_2011.pdf](http://www.dtsc.ca.gov/AssessingRisk/upload/Final_VIG_Oct_2011.pdf)

California Environmental Protection Agency (CalEPA). 2012. *Advisory: Active Soil Gas Investigations*. Department of Toxic Substances Control. April. Currently available online at: [http://www.dtsc.ca.gov/SiteCleanup/upload/VI\\_ActiveSoilGasAdvisory\\_FINAL\\_043012.pdf](http://www.dtsc.ca.gov/SiteCleanup/upload/VI_ActiveSoilGasAdvisory_FINAL_043012.pdf)

City of Mandan. 2006. Chapter 21-10: Environmental institutional control ordinance. *City of Mandan Municipal Code*, Title 21: Planning and Zoning. Currently available online at: [www.cityofmandan.com](http://www.cityofmandan.com)

Clements, W.E. and M.H. Wilkening. 1974. Atmospheric pressure effects on <sup>222</sup>Rn transport across the Earth-air interface. *Journal of Geophysical Research* 79(33):5025-5029.

Folkes, D.J. and D.W. Kurz. 2002. Efficacy of sub-slab depressurization for mitigation of vapor intrusion of chlorinated organic compounds. *Proceedings of Indoor Air 2002: The 9th International Conference on Indoor Air and Climate*. June 30-July 5.

Folkes, D.J., W. Wertz, J. Kurtz, and T. Kuehster. 2009. Observed spatial and temporal distributions of CVOCs at Colorado and New York vapor intrusion sites. *Groundwater Monitoring & Remediation* 29(1):70-80.

Frewer, L. 2004. The public and effective risk communication. *Toxicology Letters* 149:391-397.

Gorder, K.A. and E.M. Dettenmaier. 2011. Portable GC/MS methods to evaluate sources of cVOC contamination in indoor air. *Groundwater Monitoring & Remediation* 31(4):113-119.

Holden, P.A. and N. Fierer. 2005. Microbial processes in the vadose zone. *Vadose Zone Journal* 4:1-21.



- Holton, C., E. Luo, Y. Guo, P. Dahlen, P. C. Johnson, K. Gorder and E. Dettenmaier. 2013a. Multi-year monitoring of a house over a dilute CHC plume: Implications for pathway assessment using indoor air sampling and forced under-pressurization tests. *23rd Annual International Conference of the Association of Environmental Health Sciences, San Diego, CA, March 19.*
- Holton, C., H. Luo, P. Dahlen, K. Gorder, E. Dettenmaier, and P. C. Johnson. 2013b. Temporal variability of indoor air concentrations under natural conditions in a house overlying a dilute chlorinated solvent groundwater plume. *Environmental Science & Technology* 47:13347-13354.
- Interstate Technology & Regulatory Council (ITRC). 2014. *Petroleum Vapor Intrusion: Fundamentals of Screening, Investigation, and Management.* Interstate Technology and Regulatory Council, Vapor Intrusion Team, Washington, D.C. October. Currently available online at: <http://itrcweb.org/PetroleumVI-Guidance>
- Interstate Technology & Regulatory Council (ITRC). 2007a. *Vapor Intrusion Pathway: A Practical Guideline.* ITRC Vapor Intrusion Team, Washington, D.C. VI-1. January. Currently available online at: <http://www.itrcweb.org/documents/VI-1.pdf>
- Interstate Technology & Regulatory Council (ITRC). 2007b. *Vapor Intrusion Pathway: Investigative Approaches for Typical Scenarios.* ITRC Vapor Intrusion Team, Washington, D.C. VI-1A. January. Currently available online at: <http://www.itrcweb.org/documents/VI-1A.pdf>
- Izzo, V. J. 1992. *Drycleaners – A Major Source of PCE in Ground Water.* Sacramento: State of California Regional Water Quality Control Board Central Valley Region. March. Currently available online at: [http://www.swrcb.ca.gov/rwqcb5/water\\_issues/site\\_cleanup/dry\\_cleaner\\_rpt.pdf](http://www.swrcb.ca.gov/rwqcb5/water_issues/site_cleanup/dry_cleaner_rpt.pdf)
- Jia, C., S.A. Batterman, and G.E. Relyea. 2012. Variability of indoor and outdoor VOC measurements: An analysis using variance components. *Environmental Pollution* 169:152-159.
- Johnson, P.C. and R.A. Ettinger. 1991. Heuristic model for predicting the intrusion rate of contaminant vapors into buildings. *Environmental Science & Technology* 25:1445-1452.
- Little, J.C., J.M. Daisey, and W.W. Nazaroff. 1992. Transport of subsurface contaminants into buildings. *Environmental Science & Technology* 26(11): 2058– 2066.
- Lowell, P.S. and B. Eklund. 2004. VOC emission fluxes as a function of lateral distance from the source. *Environmental Progress* 23(1):52-58.
- Lundegard, P.D., P.C. Johnson, and P. Dahlen. 2008. Oxygen transport from the atmosphere to soil gas beneath a slab-on-grade foundation overlying petroleum-impacted soil. *Environmental Science & Technology* 42:5534-5540.
- Lundgren, R.E., and A.H. McMakin. 2013. *Risk Communication: A Handbook for Communicating Environmental, Safety, and Health Risks, Fifth Edition.* John Wiley & Sons.
- Luo, H., P. Dahlen, P.C. Johnson, T. Peargin, and T. Creamer. 2009. Spatial variability of soil-gas concentrations near and beneath a building overlying shallow petroleum hydrocarbon-impacted soils. *Groundwater Monitoring & Remediation* 29(1): 81–91.

- Ma, J., H. Luo, G.E. DeVaul, W.G. Rixey, and P.J.J. Alvarez. 2014. Numerical model investigation for potential methane explosion and benzene vapor intrusion associated with high-ethanol blend releases. *Environmental Science & Technology* 48:474-481.
- Ma, J., W.G. Rixey, G. E. DeVaul, B.P. Stafford, and P.J.J. Alvarez. 2012. Methane bioattenuation and implications for explosion risk reduction along the groundwater to soil surface pathway above a plume of dissolved ethanol. *Environmental Science & Technology* 46: 6013-6019.
- Markon, M. L. and L. Lemyre. 2013. Public reactions to risk messages communicating different sources of uncertainty: An experimental test. *Human and Ecological Risk Assessment* 19: 1102-1126.
- Massachusetts Department of Environmental Protection (MADEP). 2011. *Interim Final Vapor Intrusion Guidance*. WSC#-11-435. December. Currently available online at: <http://www.mass.gov/dep/cleanup/iawg.htm>
- Maupins, K. and D.T. Hitchins. 1998. Reducing employee exposure potential using the ANSI/ASHRAE 110 "Method of Testing Performance of Laboratory Fume Hoods" as a diagnostic tool. *American Industrial Hygiene Association Journal* 59(2):133-138.
- McAlary, T.A., J. Provoost, and H.D. Dawson. 2011. Vapor intrusion. *Dealing with Contaminated Sites: From Theory Towards Practical Applications*, Chapter 10. F.A. Swartjes [ed.], Springer Science.
- McBride, S.J., A.R. Ferro, W.R. Otto, P. Switzer, and L.M. Hildemann. 1999. Investigations of the proximity effect for pollutants in the indoor environment. *Journal of Exposure Analysis and Environmental Epidemiology* 9:602-621.
- McCarthy, M.C., H.R. Hafner, L.R. Chinkin, and J.G. Charrier. 2007. Temporal variability of selected air toxics in the United States. *Atmospheric Environment* 41:7180-7194.
- McDonald, G.J. and W.E. Wertz. 2007. PCE, TCE, and TCA vapors in slab soil gas and indoor air: A case study in upstate New York. *Groundwater Monitoring & Remediation* 27(4):86-92.
- McHugh, T.E., L. Beckley, and D. Bailey. 2013. Influence of shallow geology on volatile organic chemical attenuation from groundwater to deep soil gas. *Groundwater Monitoring & Remediation* 33(3):92-100.
- McHugh, T.E., L. Beckley, D. Bailey, K. Gorder, E. Dettenmaier, I. Rivera-Duarte, S. Brock, and I.C. MacGregor. 2012. Evaluation of vapor intrusion using controlled building pressure. *Environmental Science & Technology* 46:4792-4799.
- Morgan, M.G., A. Bostrom, L. Lave, and C.J. Atman. 1992. Communicating risk to the public. *Environmental Science & Technology* 26(11): 2048-2056.
- Moseley, C.L. and M.R. Meyer. 1992. Petroleum contamination of an elementary school: A case history involving air, soil-gas, and groundwater monitoring. *Environmental Science & Technology* 26(11): 185-192.

National Conference of Commissioners on Uniform State Laws. 2003. *Uniform Environmental Covenants Act*. Currently available online at:

[http://www.epa.gov/superfund/policy/ic/pdfs/kerr\\_uecalang.pdf](http://www.epa.gov/superfund/policy/ic/pdfs/kerr_uecalang.pdf)

National Research Council (NRC). 2013. *Alternatives for Managing the Nation's Complex Contaminated Groundwater Sites*. National Academies Press, Washington, D.C. Committee on Future Options for Management in the Nation's Subsurface Remediation Effort.

National Research Council (NRC). 2009. *Science and Decisions: Advancing Risk Assessment*. National Academies Press, Washington, D.C. Committee on Improving Risk Analysis Approaches Used by the U.S. EPA.

National Research Council (NRC). 2004. *Contaminants in the Subsurface: Source Zone Assessment and Remediation*. National Academies Press, Washington, D.C. Committee on Source Removal of Contaminants in the Subsurface.

New Jersey Department of Environmental Protection (NJDEP). 2012. *Vapor Intrusion Technical Guidance, Version 2.0*. Site Remediation Program. Currently available online at: [http://www.state.nj.us/dep/srp/guidance/vaporintrusion/vig\\_main.pdf](http://www.state.nj.us/dep/srp/guidance/vaporintrusion/vig_main.pdf)

Odenchantz, J.E., S.C. Thornley, and H. O'Neill. 2009. An evaluation of the performance of multiple passive diffusion devices for indoor air sampling of VOCs. *Remediation* 19(4):63-72.

Odenchantz, J.E., H. O'Neill, S.J. Steinmacher, J.D. Case, and P.C. Johnson. 2008. Residential vapor-intrusion evaluation: Long-duration passive sampling vs. short-duration active sampling. *Remediation* 18(4):49-54.

Patterson, B. M. and G.B. Davis. 2009. Quantification of Vapor Intrusion Pathways into a Slab-on-Ground Building under Varying Environmental Conditions. *Environmental Science & Technology* 43(3): 650-656.

Patterson, B. M., R. Aravena, G.B. Davis, A.J. Furness, T.P. Bastow, and D. Bouchard. 2013. Multiple lines of evidence to demonstrate vinyl chloride aerobic biodegradation in the vadose zone, and factors controlling rates. *J. Contaminant Hydrology* 153(1) 69-77.

Pennell, K.G., M.K. Scammell, M.D. McClean, J. Ames, B. Weldon, L. Friguglietti, E.M. Suuberg, R. Shen, P.A. Indeglia, and W.J. Heiger-Bernays. 2013. Sewer gas: An indoor air source of PCE to consider during vapor intrusion investigations. *Groundwater Monitoring & Remediation* 33(3):119-126.

Robinson, A.L. and R.G. Sextro. 1997. Radon entry into buildings driven by atmospheric pressure fluctuations. *Environmental Science & Technology* 31(6):1742-1748.

Rossner, A., J.P. Farant, P. Simon, and D.P. Wick. 2002. Development of a Flow Controller for Long-Term Sampling of Gases and Vapors Using Evacuated Canisters. *Environmental Science & Technology* 36(22): 4912-4920.

Rossner, A. and D.P. Wick. 2005. A field study to assess the long-term sampling feasibility of evacuated canisters and the development of a mathematical model to analyze potential sampling bias. *J. Occupational Environmental Hygiene* 2(9): 474-480

Rydock, J.P. 2001. Reality-check your fume hoods. *Today's Chemist at Work* 10(06):19-20.

Sihota, N.J., K. U. Mayer, M.A. Toso, and J.F. Atwater. 2013. Methane emissions and contaminant degradation rates at sites affected by accidental releases of denatured fuel-grade ethanol. *Journal of Contaminant Hydrology* 151:1-5.

Strategic Environmental Research and Development Program and Environmental Security Technology Certification Program (SERDP-ESTCP). 2014. *SERDP and ESTCP Workshop on Vapor Intrusion into Indoor Air from Contaminated Groundwater (Summary Report)*. March. Currently available online at: <http://www.serdp-estcp.org/Featured-Initiatives/Cleanup-Initiatives/Vapor-Intrusion>

Tilman, F.D. and J.W. Weaver. 2007. Temporal moisture content variability beneath and external to a building and the potential effects on vapor intrusion risk assessment. *Science of the Total Environment* 379:1-15.

U.S. Department of Defense (DoD). 2009. *DoD Vapor Intrusion Handbook*. January. Currently available online at: <http://www.environmental.usace.army.mil/docs/DoD%20VI%20Handbook%20Final%20Jan%2009.pdf?syspage=documents&id=129239>

U.S. Department of the Navy (DoN). 2011a. *Guidance for Environmental Background Analysis, Volume IV: Vapor Intrusion Pathway*. Naval Facilities Engineering Command, Washington, D.C. April.

U.S. Department of the Navy (DoN). 2011b. *Vapor Intrusion Mitigation in Existing Buildings Fact Sheet*. Naval Facilities Engineering Command, Washington, D.C. May.

U.S. Department of the Navy (DoN). 2011c. *Vapor Intrusion Mitigation in Construction of New Buildings Fact Sheet*. Naval Facilities Engineering Command, Washington, D.C. August.

U.S. Environmental Protection Agency (EPA). 2015a. *Vapor Intrusion Screening Level (VISL) Calculator, User's Guide*. Currently available online at: <http://www.epa.gov/oswer/vaporintrusion/guidance.html>

U.S. Environmental Protection Agency (EPA). 2015b. *Technical Guide for Addressing Petroleum Vapor Intrusion at Leaking Underground Storage Tank Sites* [EPA 510-R-15-001]. Office of Solid Waste and Emergency Response, Office of Underground Storage Tanks.

U.S. Environmental Protection Agency (EPA). 2014a. *Human Health Evaluation Manual, Supplemental Guidance: Update of Standard Default Exposure Factors*. Memorandum from Dana Stalcup. Office of Superfund Remediation and Technology Innovation, Washington, D.C. February 6. Currently available online at:

<http://www.epa.gov/oswer/riskassessment/pdf/superfund-hh-exposure/OSWER-Directive-9200-1-120-ExposureFactors.pdf>

U.S. Environmental Protection Agency (EPA). 2014b. *Compilation of Information Relating to Early/Interim Actions at Superfund Sites and the TCE IRIS Assessment*. Memorandum from Robin Richardson. Office of Superfund Remediation and Technology Innovation, Washington, D.C. August 27. Currently available online at:

[http://www.epa.gov/superfund/sites/npl/TCE\\_compilation\\_final.pdf](http://www.epa.gov/superfund/sites/npl/TCE_compilation_final.pdf)

U.S. Environmental Protection Agency (EPA). 2013a. *Evaluation of Empirical Data to Support Soil Vapor Intrusion Screening Criteria for Petroleum Hydrocarbon Compounds*. Office of Underground Storage Tanks, Washington, D.C. EPA-510-R-13-001. January. Currently available online at: [http://www.epa.gov/oust/cat/pvi/PVI\\_Database\\_Report.pdf](http://www.epa.gov/oust/cat/pvi/PVI_Database_Report.pdf)

U.S. Environmental Protection Agency (EPA). 2013b. *Consumer's Guide to Radon Reduction*. EPA 402/K-10/005. Office of Radiation and Indoor Air (ORIA), Indoor Environments Division. Washington, DC. September. Currently available online at:

<http://www.epa.gov/radon/pubs/consguid.html>

U.S. Environmental Protection Agency (EPA). 2012a. *EPA's Vapor Intrusion Database: Evaluation and Characterization of Attenuation Factors for Chlorinated Volatile Organic Compounds and Residential Buildings*. EPA-530-R-10-002. March. Currently available online at:

[http://www.epa.gov/oswer/vaporintrusion/documents/OSWER\\_2010\\_Database\\_Report\\_03-16-2012\\_Final.pdf](http://www.epa.gov/oswer/vaporintrusion/documents/OSWER_2010_Database_Report_03-16-2012_Final.pdf)

U.S. Environmental Protection Agency (EPA). 2012b. *Conceptual Model Scenarios for the Vapor Intrusion Pathway*. EPA-530-R-10-003. February. Currently available online at:

<http://www.epa.gov/oswer/vaporintrusion/documents/vi-cms-v11final-2-24-2012.pdf>

U.S. Environmental Protection Agency (EPA). 2012c. *Assessing Protectiveness at Sites for Vapor Intrusion: Supplement to the "Comprehensive Five-Year Review Guidance."* OSWER Directive 9200.2-84. Currently available online at:

[http://www.epa.gov/superfund/cleanup/postconstruction/pdfs/VI\\_FYR\\_Guidance-Final-11-14-12.pdf](http://www.epa.gov/superfund/cleanup/postconstruction/pdfs/VI_FYR_Guidance-Final-11-14-12.pdf)

U.S. Environmental Protection Agency (EPA). 2012d. *Institutional Controls: A Guide to Planning, Implementing, Maintaining, and Enforcing Institutional Controls at Contaminated Sites*. OSWER 9355.0-89, EPA-540-R-09-001. December. Currently available online at:

<http://www.epa.gov/superfund/policy/ic/guide/Final%20PIME%20Guidance%20December%20012.pdf>

U.S. Environmental Protection Agency (EPA). 2012e. *Institutional Controls: A Guide to Preparing Institutional Control Implementation and Assurance Plans at Contaminated Sites*. OSWER #9200.0-77, EPA-540-R-09-002. December. Currently available online at:

[http://www.epa.gov/superfund/policy/ic/guide/ICIAP%20guidance%20\(FINAL\)%20-%2012.04.2012.pdf](http://www.epa.gov/superfund/policy/ic/guide/ICIAP%20guidance%20(FINAL)%20-%2012.04.2012.pdf)

U.S. Environmental Protection Agency (EPA). 2012f. *Fluctuation of Indoor Radon and VOC Concentrations Due to Seasonal Variations*. National Exposure Research Laboratory, Las Vegas, Nevada. EPA/600/R-12/673. September. Currently available online at: [http://cfpub.epa.gov/si/si\\_public\\_record\\_report.cfm?dirEntryId=247212&fed\\_org\\_id=770&SIType=PR&TIMSType=Published+Report&showCriteria=0&address=nerl/pubs.html&view=citation&ortBy=pubDateYear&count=100&dateBeginPublishedPresented=01/01/2010](http://cfpub.epa.gov/si/si_public_record_report.cfm?dirEntryId=247212&fed_org_id=770&SIType=PR&TIMSType=Published+Report&showCriteria=0&address=nerl/pubs.html&view=citation&ortBy=pubDateYear&count=100&dateBeginPublishedPresented=01/01/2010)

U.S. Environmental Protection Agency (EPA). 2011a. *Background Indoor Air Concentrations of Volatile Organic Compounds in North American Residences (1990-2005): A Compilation of Statistics for Assessing Vapor Intrusion*. Office of Solid Waste and Emergency Response, Washington, D.C. EPA-530-R-10-001. June. Currently available online at: <http://www.epa.gov/oswer/vaporintrusion/documents/oswer-vapor-intrusion-background-Report-062411.pdf>

U.S. Environmental Protection Agency (EPA). 2011b. *Exposure Factors Handbook – 2011 Edition*. Office of Research and Development, Washington, D.C. EPA/600/R-090/052F. September. Currently available online at: <http://www.epa.gov/ncea/efh/pdfs/efh-complete.pdf>

U.S. Environmental Protection Agency (EPA). 2011c. *Recommended Evaluation of Institutional Controls: Supplement to the “Comprehensive Five-Year Review Guidance.”* OSWER Directive 9355.7-18. September. Currently available online at: <http://www.epa.gov/superfund/cleanup/postconstruction/641333.pdf>

U.S. Environmental Protection Agency (EPA). 2010a. *Clarification of CERCLA Entry Policy*. Office of Enforcement and Compliance Monitoring. Washington, D.C. Memorandum from Kenneth Patterson. March 3. Currently available online at: <http://www2.epa.gov/sites/production/files/documents/access-clarify-10.pdf>

U.S. Environmental Protection Agency (EPA). 2010b. *Review of the Draft 2002 Subsurface Vapor Intrusion Guidance*. Office of Solid Waste and Emergency Response, Washington, D.C. August.

U.S. Environmental Protection Agency (EPA). 2010c. *Considering Reasonably Anticipated Future Land Use and Reducing Barriers to Reuse at EPA-Lead Superfund Remedial Sites*. OSWER Directive 9355.7-19. March. Currently available online at: <http://www.epa.gov/superfund/programs/recycle/pdf/reusedirective.pdf>

U.S. Environmental Protection Agency (EPA). 2009a. *Evaluation Report: Lack of Final Guidance on Vapor Intrusion Impedes Efforts to Address Indoor Air Risks*. Report No. 10-P-0042. EPA Office of Inspector General, Washington, D.C. December. Currently available online at: <http://www.epa.gov/oig/reports/2010/20091214-10-P-0042.pdf>

U.S. Environmental Protection Agency (EPA). 2009b. *Operational and Functional Determination and the Transfer of Fund-Lead Vapor Intrusion Mitigation Systems to the State*. OSWER 9200.2-72. April. Currently available online at: <http://www.epa.gov/superfund/policy/pdfs/VaporGuidance04092009.pdf>

U.S. Environmental Protection Agency (EPA). 2009c. *Risk Assessment Guidance for Superfund (RAGS), Volume I: Human Health Evaluation Manual (Part F, Supplemental Guidance for Inhalation Risk Assessment)*. Office of Superfund Remediation and Technology Innovation,

Washington, D.C. OSWER 9285.7-82, EPA-540-R-070-002. January. Currently available on-line at <http://www.epa.gov/oswer/riskassessment/ragsfi/index.htm>

U.S. Environmental Protection Agency (EPA). 2008a. *Brownfields Technology Primer: Vapor Intrusion Considerations for Redevelopment*. EPA-542-R-08-001. March. Currently available online at: [www.brownfieldstsc.org/pdfs/BTSC%20Vapor%20Intrusion%20Considerations%20for%20Redevelopment%20EPA%20542-R-08-001.pdf](http://www.brownfieldstsc.org/pdfs/BTSC%20Vapor%20Intrusion%20Considerations%20for%20Redevelopment%20EPA%20542-R-08-001.pdf)

U.S. Environmental Protection Agency (EPA). 2008b. *Superfund Environmental Indicators Guidance: Human Exposure Revisions*. Office of Superfund Remediation and Technology Assessment, Washington, D.C. March. Currently available online at: [http://www.epa.gov/superfund/accomp/ei/pdfs/final\\_ei\\_guidance\\_march\\_2008.pdf](http://www.epa.gov/superfund/accomp/ei/pdfs/final_ei_guidance_march_2008.pdf)

U.S. Environmental Protection Agency (EPA). 2008c. *Engineering Issue: Indoor Air Vapor Intrusion Mitigation Approaches*. EPA/600/R-08/115. October. Currently available online at: <http://www.clu-in.org/download/char/600r08115.pdf>

U.S. Environmental Protection Agency (EPA). 2007. *Risk Communication in Action: The Risk Communication Workbook*. EPA/625/R-05/003. August. Currently available online at: <http://nepis.epa.gov/Adobe/PDF/6000012U.pdf>

U.S. Environmental Protection Agency (EPA). 2006a. *Guidance on Systematic Planning Using the Data Quality Objectives Process (EPA QA/G-4)*. Office of Environmental Information. Washington, D.C. EPA-240-B-06-001. February. Currently available online at: <http://www.epa.gov/quality/qs-docs/g4-final.pdf>

U.S. Environmental Protection Agency (EPA). 2006b. *Assessment of Vapor Intrusion in Homes near the Raymark Superfund Site Using Basement and Subslab Air Samples*. EPA/600/R-05/147. March. Currently available online at: <http://nepis.epa.gov/Exe/ZyPURL.cgi?Dockey=2000D268.txt>

U.S. Environmental Protection Agency (EPA). 2006c. *In Situ Treatment Technologies for Contaminated Soil*. Office of Solid Waste and Emergency Response, Washington, D.C. EPA-542-F-06-013. November. Currently available on-line at: <http://www.cluin.org/download/remed/542f06013.pdf>

U.S. Environmental Protection Agency (EPA). 2005. *Guidance for Evaluating Landfill Gas Emissions from Closed or Abandoned Facilities*. EPA/600/R-05/123a. September. Currently available online at: <http://nepis.epa.gov/Exe/ZyPURL.cgi?Dockey=P1000BRN.txt>

U.S. Environmental Protection Agency (EPA). 2003. *Human Health Toxicity Values in Superfund Risk Assessments*. OSWER Directive 9285.7-53. December 5. Currently available online at: <http://www.epa.gov/oswer/riskassessment/pdf/hhmemo.pdf>

U.S. Environmental Protection Agency (EPA). 2002a. *Ground-Water Sampling Guidelines for Superfund and RCRA Project Managers*. EPA-542-S-02-001. May. Currently available online at: [http://www.epa.gov/tio/tsp/download/gw\\_sampling\\_guide.pdf](http://www.epa.gov/tio/tsp/download/gw_sampling_guide.pdf)

U.S. Environmental Protection Agency (EPA). 2002b. *Office of Inspector General Recommendations Concerning RCRA Corrective Action Environmental Indicators*. Office of Solid Waste, Washington, D.C. Currently available online at: <http://www.epa.gov/osw/hazard/correctiveaction/pdfs/eiigmemo.pdf>

U.S. Environmental Protection Agency (EPA). 2002c. *OSWER Draft Guidance for Evaluating the Vapor Intrusion to Indoor Air Pathway from Groundwater and Soils (Subsurface Vapor Intrusion Guidance)*. Office of Solid Waste and Emergency Response, Washington, D.C. EPA-530-D-02-004. November.

U.S. Environmental Protection Agency (EPA). 2002d. *Superfund Response Actions: Temporary Relocations Implementation Guidance*. Office of Solid Waste and Emergency Response, Washington, D.C. OSWER Directive 9230.0-97. April. Currently available online at: <http://www.epa.gov/superfund/community/relocation/tempreloc.pdf>

U.S. Environmental Protection Agency (EPA). 2002e. *Role of Background in the CERCLA Cleanup Program*. OSWER Directive 9285.6-07P. Office of Emergency and Remedial Response, Washington, D.C. May. Currently available online at: <http://www.epa.gov/oswer/riskassessment/pdf/role.pdf>

U.S. Environmental Protection Agency (EPA). 2001. *Comprehensive Five-Year Review Guidance*. OSWER 9355.7-03B-P, EPA-540-R-01-007. June. Currently available online at: <http://www.epa.gov/superfund/cleanup/postconstruction/5yr.htm>

U.S. Environmental Protection Agency (EPA). 2000a. *Data Quality Objectives Process for Hazardous Waste Site Investigations: EPA QA/G-4HW*. EPA/600/R-00/007. January. Currently available online at: <http://www.epa.gov/quality/qs-docs/g4hw-final.pdf>

U.S. Environmental Protection Agency (EPA). 2000b. *Risk Characterization Handbook*. Science Policy Council, Washington, D.C. EPA-100-B-00-002. December. Currently available online at: <http://nepis.epa.gov/Exe/ZyPURL.cgi?Dockey=40000006.TXT>

U.S. Environmental Protection Agency (EPA). 1999a. *Interim-Final Guidance for RCRA Corrective Action Environmental Indicators*. Office of Solid Waste, Washington, D.C. February 5. Currently available online at: [http://www.epa.gov/osw/hazard/correctiveaction/eis/ei\\_guida.pdf](http://www.epa.gov/osw/hazard/correctiveaction/eis/ei_guida.pdf)

U.S. Environmental Protection Agency (EPA). 1999b. *A Guide to Preparing Superfund Proposed Plans, Records of Decision, and Other Remedy Selection Documents*. Office of Solid Waste and Emergency Response, Washington, D.C. EPA-540-R-98-031. July. Currently available online at: [http://www.epa.gov/superfund/policy/remedy/rods/pdfs/guide\\_decision\\_documents\\_071999.pdf](http://www.epa.gov/superfund/policy/remedy/rods/pdfs/guide_decision_documents_071999.pdf)

U.S. Environmental Protection Agency (EPA). 1999c. Compendium Method TO-14A. Determination of volatile organic compounds (VOCs) in ambient air using specially prepared canisters with subsequent analysis by gas chromatography. *Compendium of Methods for the Determination of Toxic Organic Compounds in Ambient Air, Second Edition*. Center for Environmental Research Information, Office of Research and Development, Cincinnati, Ohio. EPA/625/R-96/010b. January. Available online at <http://www.epa.gov/ttnamti1/airtox.html>.



U.S. Environmental Protection Agency (EPA). 1999d. Compendium Method TO-15. Determination of volatile organic compounds (VOCs) in air collected in specially-prepared canisters and analyzed by gas chromatography/mass spectrometry (GC/MS). *Compendium of Methods for the Determination of Toxic Organic Compounds in Ambient Air, Second Edition*. Center for Environmental Research Information, Office of Research and Development, Cincinnati, Ohio. EPA/625/R-96/010b. January. Available online at <http://www.epa.gov/ttnamti1/airtox.html>.

U.S. Environmental Protection Agency (EPA). 1999e. Compendium Method TO-17. Determination of volatile organic compounds in ambient air using active sampling onto sorbent tubes. *Compendium of Methods for the Determination of Toxic Organic Compounds in Ambient Air, Second Edition*. Center for Environmental Research Information, Office of Research and Development, Cincinnati, Ohio. EPA/625/R-96/010b. January. Available online at <http://www.epa.gov/ttnamti1/airtox.html>.

U.S. Environmental Protection Agency (EPA). 1999f. *Interim Policy on the Use of Permanent Relocations as Part of Superfund Remedial Actions*. OSWER Directive 9355.0-71P. Office of Solid Waste and Emergency Response Washington, DC. Currently available on-line at: <http://www.epa.gov/superfund/community/relocation/intpol.htm>

U.S. Environmental Protection Agency (EPA). 1998. *Technical Guidance Document: Compliance Assurance Monitoring, Revised Draft*. Office of Air Quality Planning and Standards, Research Triangle Park, NC. August. Currently available online at: <http://www.epa.gov/ttn/emc/cam.html>

U.S. Environmental Protection Agency (EPA). 1997. *Rules of Thumb for Superfund Remedy Selection*. OSWER Directive 9355.0-69. August. Currently available online at: <http://www.epa.gov/oerrpage/superfund/policy/remedy/rules/index.htm>

U.S. Environmental Protection Agency (EPA). 1995a. *Land Use in CERCLA Remedy Selection Process*. OSWER Directive 9355.7-04. May. Currently available online at: <http://www.epa.gov/superfund/community/relocation/landuse.pdf>

U.S. Environmental Protection Agency (EPA). 1995b. *Guidance for Risk Characterization*. Science Policy Council, Washington, D.C. February. Currently available online at: <http://www.epa.gov/osainter/spc/pdfs/rcguide.pdf>

U.S. Environmental Protection Agency (EPA). 1995c. *Engineering Forum Issue Paper. Determination of Background Concentrations of Inorganics in Soils and Sediments at Hazardous Waste Sites*, EPA/540/S-96/500. Office of Research and Development, Office of Solid Waste and Emergency Response, Washington, DC. Currently available online at: <http://www.epa.gov/osp/hstl/tsc/Breckenridge1995.pdf>

U.S. Environmental Protection Agency (EPA). 1994. *RCRA Corrective Action Plan (Final)*. OSWER Directive 9902.3-2A. Office of Solid Waste, Washington, DC. Currently available online at:

[http://www.epa.gov/epawaste/hazard/correctiveaction/resources/guidance/gen\\_ca/rcracap.pdf](http://www.epa.gov/epawaste/hazard/correctiveaction/resources/guidance/gen_ca/rcracap.pdf)

U.S. Environmental Protection Agency (EPA). 1993a. *Radon Reduction Techniques for Existing Detached Houses: Technical Guidance (Third Edition) for Active Soil Depressurization Systems*. EPA-625-R-93-011. October. Currently available online at:

<http://nepis.epa.gov/Exe/ZyPURL.cgi?Dockey=30004MR2.txt>

U.S. Environmental Protection Agency (EPA). 1993b. *Presumptive Remedies: Site Characterization and Technology Selection for CERCLA Sites with VOCs in Soils*.

U.S. Environmental Protection Agency (EPA). 1993c. *Air/Superfund National Technical Guidance Study Series: Options for Developing and Evaluating Mitigation Strategies for Indoor Air Impacts at CERCLA Sites*. Office of Air Quality Planning and Standards. EP-451/R-93-012, September. Currently available on-line at: <http://www.epa.gov/nscep/index.html>

U.S. Environmental Protection Agency (EPA). 1992a. *Guidance for Data Useability in Risk Assessment, Part A*. Currently available online at:

<http://www.epa.gov/oswer/riskassessment/datause/parta.htm>

U.S. Environmental Protection Agency (EPA). 1992b. *Early Action and Long-Term Action under SACM – Interim Guidance*. Office of Solid Waste and Emergency Response, Washington, D.C. Publication 9203.1-051. December.

U.S. Environmental Protection Agency (EPA). 1992c. *Guidance on Risk Characterization for Risk Managers and Risk Assessors*. Memorandum from F. Henry Habicht II, Deputy Administrator, Washington, D.C. February 26. Currently available online at:

<http://www.epa.gov/oswer/riskassessment/pdf/habicht.pdf>

U.S. Environmental Protection Agency (EPA). 1991a. *Role of the Baseline Risk Assessment in Superfund Remedy Selection Decisions*. Office of Solid Waste and Emergency Response. Washington, D.C. OSWER Directive 9355.0-30. April. Currently available online at:

<http://www.epa.gov/oswer/riskassessment/pdf/baseline.pdf>.

U.S. Environmental Protection Agency (EPA). 1991b. *Risk Assessment Guidance for Superfund (RAGS), Volume I: Human Health Evaluation Manual (Part B, Development of Preliminary Remediation Goals), Interim*. Office of Emergency and Remedial Response, Washington, D.C. EPA-540-R-92-003. December. Currently available on-line at

<http://www.epa.gov/oswer/riskassessment/ragsb/index.htm>

U.S. Environmental Protection Agency (EPA). 1991c. *Risk Assessment Guidance for Superfund (RAGS), Volume I: Human Health Evaluation Manual (Part C, Risk Evaluation of Remedial Alternatives), Interim*. Office of Emergency and Remedial Response, Washington, D.C. Publication 9285.7-01C. October. Currently available on-line at

<http://www.epa.gov/oswer/riskassessment/ragsc/index.htm>

U.S. Environmental Protection Agency (EPA). 1989. *Risk Assessment Guidance for Superfund, Volume I Human Health Evaluation Manual (Part A), Interim Final*. Office of Emergency and Remedial Response, Washington, D.C. EPA-540-1-89-002. December. Currently available online at: <http://www.epa.gov/oswer/riskassessment/ragsa/index.htm>.

U.S. Environmental Protection Agency (EPA). 1987. *Entry and Continued Access under CERCLA*. Office of Enforcement and Compliance Monitoring, Washington, D.C. Publication 9829.2. June 5. Currently available online at: <http://www2.epa.gov/sites/production/files/2013-09/documents/cont-access-mem.pdf>

U.S. Environmental Protection Agency (EPA). 1986. *Inspection Authority under Section 3007 of RCRA*. Office of General Counsel, Washington, D.C. Memorandum from Francis Blake. April 17. Currently available online at: <http://www2.epa.gov/enforcement/guidance-rcra-section-3007-inspection-authority>

U.S. Environmental Protection Agency, Environmental Response Team (EPA-ERT). 2012. *Standard Operating Procedures, Trace Atmospheric Gas Analyzer (TAGA) IIE Operation (SOP 1711)*. October 22. Currently available online at: <http://www.epaosc.org/sites/2107/files/1711-r00.pdf>

U.S. Environmental Protection Agency, Environmental Response Team (EPA-ERT). 2007. *Standard Operating Procedures, Construction and Installation of Permanent Sub-Slab Soil Gas Wells (SOP 2082)*. March 29. Currently available online at: <http://www.epaosc.org/sites/2107/files/2082-r00.pdf>

U.S. Environmental Protection Agency, Environmental Response Team (EPA-ERT). 2001a. *Standard Operating Procedures, Groundwater Well Sampling (SOP 2007)*. April 16. Currently available online at: <http://www.epaosc.org/sites/2107/files/2007-R00.pdf>

U.S. Environmental Protection Agency, Environmental Response Team (EPA-ERT). 2001b. *Standard Operating Procedures, Soil Sampling (SOP 2012)*. July 11. Currently available online at: <http://www.epaosc.org/sites/2107/files/2012-r10.pdf>

U.S. Environmental Protection Agency, Environmental Response Team (EPA-ERT). 2001c. *Standard Operating Procedures, Soil Gas Sampling (SOP 2042)*. April 18. Currently available online at: <http://www.epaosc.org/sites/2107/files/2082-r00.pdf>

U.S. Environmental Protection Agency, Environmental Response Team (EPA-ERT). 1995. *Standard Operating Procedures, Summa Canister Sampling (SOP 1701)*. July 27. Currently available online at: <http://www.epaosc.org/sites/2107/files/1704-R01.pdf>

U.S. Environmental Protection Agency, Region 9 (EPA-Region 9). 2010. R9's "RARE" Opportunity to Improve Vapor Intrusion Indoor Air Investigations. EPA Vapor Intrusion Forum. June 14.

U.S. Environmental Protection Agency, Risk Assessment Forum (EPA-RAF). 2014. *Framework for Human Health Risk Assessment to Inform Decision Making*. Office of Science Advisor, Washington, D.C. April. Currently available online at: <http://www2.epa.gov/sites/production/files/2014-12/documents/hhra-framework-final-2014.pdf>

U.S. Environmental Protection Agency (EPA-SPC). 2006. *Peer Review Handbook, 3rd Edition*. EPA/100/B-06/002. Science Policy Council, Washington DC. Currently available online at: [http://www2.epa.gov/sites/production/files/2014-12/documents/peer\\_review\\_handbook\\_3rd\\_ed.pdf](http://www2.epa.gov/sites/production/files/2014-12/documents/peer_review_handbook_3rd_ed.pdf)

U.S. Postal Service (USPS). 2009. *Vapor Intrusion Guidance, Volume 1*. September.

Vroblesky, D.A., M.D. Petkewich, M.A. Lowery, and J.E. Landmeyer. 2011. Sewers as a source and sink of chlorinated-solvent groundwater contamination, Marine Corps Recruit Depot, Parris Island, South Carolina. *Groundwater Monitoring & Remediation* 31(4):63-69.

## APPENDIX A

### RECOMMENDED SUBSURFACE-TO-INDOOR AIR ATTENUATION FACTORS

#### A.1 INTRODUCTION

This Technical Guide includes recommended medium-specific (groundwater, soil gas, and indoor air) Vapor Intrusion Screening Levels (VISLs) that are intended to help identify those sites unlikely to pose a health concern from vapor intrusion and identify areas or buildings that may warrant further investigation of the vapor intrusion pathway. These VISLs are recommended for use in evaluating the concentrations of vapor-forming chemicals measured in groundwater, “near-source” exterior soil gas, and sub-slab soil gas in residential and nonresidential settings where the potential for vapor intrusion is under investigation.

The subsurface VISLs are developed considering a generic conceptual model for vapor intrusion consisting of a groundwater or vadose zone source of vapor-forming chemicals that diffuse upwards through unsaturated soils towards the surface and enter buildings. The underlying assumption for this generic model is that subsurface characteristics will tend to reduce or attenuate soil gas concentrations as vapors migrate upward from the source and into structures. Section 6.5.2 describes this conceptual model further. In general, EPA recommends considering whether the assumptions underlying the generic conceptual model are attained at each site. The *Vapor Intrusion Screening Level (VISL) Calculator User’s Guide* (EPA 2015a) provides additional information about the technical basis for deriving the VISLs.

Comparison of sampling results to medium-specific VISLs (see Section 6.5.4) comprises one line of evidence in the multiple-lines-of-evidence approach described in this Technical Guide (see, for example, Sections 7.1 and 7.2). The subsurface (groundwater and soil gas) VISLs ( $C_{VISL}$ ) are calculated using risk-based, screening levels for indoor air ( $C_{target,ia}$ ) and a medium-specific, subsurface-to-indoor air attenuation factor ( $\alpha_{VI}$ ), as follows:

$$C_{VISL} = \frac{C_{target,ia}}{\alpha_{VI}} \quad \text{Equation A.1}$$

The risk-based, indoor air screening levels ( $C_{target,ia}$ ) are calculated according to the guidance provided in *Risk Assessment Guidance for Superfund (RAGS) Part F* (EPA 2009) as implemented in EPA’s Regional Screening Levels (RSLs) for Chemical Contaminants at Superfund Sites ([http://www.epa.gov/reg3hwmd/risk/human/rb-concentration\\_table/](http://www.epa.gov/reg3hwmd/risk/human/rb-concentration_table/)). The medium-specific, attenuation factors ( $\alpha_{VI}$ ) recommended for calculating the subsurface VISLs are derived from information in *EPA’s Vapor Intrusion Database: Evaluation and Characterization of Attenuation Factors for Chlorinated Volatile Organic Compounds and Residential Buildings* (EPA 2012a).

This appendix describes the technical basis for the selection of the subsurface-to-indoor air attenuation factors ( $\alpha_{VI}$ ) that are recommended for use in calculating the VISLs for groundwater, sub-slab soil gas, “near-source” exterior soil gas, and crawl space air, according to Equation A.1.

## A.2 DEFINITION AND DESCRIPTION OF ATTENUATION FACTOR

Vapor attenuation refers to the reduction in concentration of vapor-forming chemicals that occurs during vapor migration in the subsurface, coupled with the dilution that can occur when the vapors enter a building and mix with indoor air (Johnson and Ettinger 1991). The aggregate effect of these physical and chemical attenuation mechanisms can be quantified through the use of a subsurface-to-indoor air vapor intrusion attenuation factor ( $\alpha_{VI}$ ), which is defined as the ratio of the indoor air concentration arising from vapor intrusion ( $C_{IA-VI}$ ) to the subsurface vapor concentration ( $C_{SV}$ ) at the source or a depth of interest in the vapor migration route (EPA 2012a):

$$\alpha_{VI} = \frac{C_{IA-VI}}{C_{SV}} \alpha_{VI} = \frac{C_{IA-VI}}{C_{SV}} \quad \text{Equation A.2}$$

As defined here, the vapor attenuation factor is an inverse measurement of the overall dilution that occurs as vapors migrate from a point of measurement in the subsurface into a building; i.e., attenuation factor values decrease with increasing dilution of vapor concentration.

Subsurface vapor concentrations ( $C_{SV}$ ) may be measured directly under a building (often called sub-slab soil gas or just sub-slab), measured exterior to a building at any depth in the unsaturated zone (often called exterior soil gas), or derived from groundwater concentrations by converting the dissolved concentration to a vapor concentration assuming equilibrium conditions (i.e., by multiplying the groundwater concentration by the chemical's dimensionless Henry's law constant for the groundwater temperature *in situ*) (EPA 2001); also see Appendix C of this Technical Guide.

Subfloor vapor concentrations may also be measured in building crawl spaces. Although crawl space samples are not strictly subsurface samples, they represent the vapor concentration underlying a building's living space. Thus, crawl space samples may be evaluated in a manner similar to subsurface vapor samples.

## A.3 RECOMMENDED ATTENUATION FACTORS

This section summarizes the technical basis and rationale for EPA's recommended attenuation factors for groundwater, sub-slab soil gas, exterior soil gas, and crawl space air, as follows:

- Section A.3.1 summarizes EPA's database of empirical attenuation factor values and the results of analyzing that database.
- Section A.3.2 identifies the recommended empirically based attenuation factors for groundwater.
- Section A.3.3 identifies the recommended attenuation factor for sub-slab soil gas and presents a theoretical analysis that supports the selection of the recommended empirically based value.
- Section A.3.4 recommends a generic attenuation factor for exterior soil gas and discusses its basis, justification, and limited applications.

- Section A.3.5 identifies the recommended attenuation factor for crawlspace vapor.
- Section A.3.6 presents a reliability analysis of the recommended generic attenuation factors.

### A.3.1 EPA'S VAPOR INTRUSION DATABASE (EPA 2012A)

The information in *EPA's Vapor Intrusion Database: Evaluation and Characterization of Attenuation Factors for Chlorinated Volatile Organic Compounds and Residential Buildings* (EPA 2012a) is used to derive recommended attenuation factor values for use in evaluating subsurface sample concentrations collected as part of vapor intrusion investigations. EPA's vapor intrusion database consists of numerous pairings of concentrations in indoor air and subsurface samples (groundwater, sub-slab soil gas, exterior soil gas, and crawlspace vapor) from actual sites. It represents the most comprehensive compilation of vapor intrusion data for chlorinated hydrocarbons (CHCs) available at this time.

EPA's vapor intrusion database was analyzed and screened to reduce the impacts of background sources to indoor air concentrations. The resulting data distributions are considered representative of vapor intrusion of CHCs from subsurface vapor sources into residential buildings for most conditions. These distributions serve as the basis for identifying the high-end (conservative) attenuation factors for those media.

Table A-1 and Figure A-1 (Table 19 and Figure 34, respectively, in EPA (2012a)) present and compare the distributions of the attenuation factors (groundwater, exterior soil gas, sub-slab soil gas, and crawl space) that remain after applying the respective source strength and indoor air screens considered most effective at reducing the influence of background contributions to indoor air concentrations. These data demonstrate that the attenuation factor distributions obtained for groundwater, sub-slab soil gas, and crawl spaces for multiple buildings and sites are consistent with the conceptual model for vapor intrusion, which predicts that greater attenuation is expected with greater depths to the vapor sources or vapor samples. As shown in Table A-1 and Figure A-1, the paired groundwater–indoor air data generally exhibit greater attenuation (lower attenuation factors) than the paired sub-slab soil gas–indoor air data, which in turn exhibit greater attenuation than the paired crawl space–indoor air data.

### A.3.2 RECOMMENDED ATTENUATION FACTORS FOR GROUNDWATER

To account for the inherent temporal and spatial variability in indoor air and subsurface vapor concentrations, the 95<sup>th</sup> percentile value of the “source-screened” groundwater data subset in EPA 2012a is recommended as a reasonably conservative generic attenuation factor, after considering a range of values. **Thus, for groundwater, the recommended generic attenuation factor ( $\alpha_{gw}$ ) is 0.001.** This value is considered to apply for any soil type in the vadose zone (excepting where preferential vapor pathways are present; see Section 5.4) in cases where the groundwater is greater than five feet below the ground surface. If the depth to groundwater is less than five feet below the building foundation, investigation of the indoor space is recommended, as there is potential for contaminated groundwater to contact the building foundation, either because the capillary fringe intersects the building foundation or groundwater fluctuations results in groundwater wetting the foundation.

Table A-2 (Table 13 in EPA (2012a)) provides statistics and Figure A-2 (Figure 28 in EPA (2012a)) shows box-and-whisker plots for individual sites compared with the statistics for the combined set of screened groundwater attenuation factors. This table and figure show that the 95<sup>th</sup> percentile value of the combined groundwater-indoor air measurements is considered appropriate for estimating reasonable maximum indoor air concentrations that might be observed at a site due to vapor intrusion. The majority of sites and buildings would be expected to exhibit lower indoor air concentrations.

A factor that commonly results in greater attenuation (lower attenuation factors) is the presence of laterally extensive, unfractured fine-grained sediment in the vadose zone. Table A-3 (Table 14 in EPA (2012a)) provides selected statistics and Figure A-3 (Figure 29 in EPA (2012a)) shows the box-and-whisker plots for the groundwater attenuation factors for three soil types. Comparing each descriptive statistic (except for the 25<sup>th</sup> percentile values) indicates that the attenuation factor values for residences overlying soils classified as “very coarse” generally are larger than those for residences overlying soils classified as “coarse,” which are larger than those for soils classified as “fine.” This pattern is consistent with the conceptual model for vapor intrusion; smaller attenuation factors, which indicate greater reduction in vapor concentration, would be expected in vadose zones with finer-grained soils, when all other factors (e.g., depth to groundwater, biodegradability of the volatile chemicals) are the same. The 95<sup>th</sup> percentile value of the coarse-grained soil is equal to the generic value, as expected, since coarse-grained soil provide low resistance to vapor transport and thus would be expected to yield high-valued attenuation factors. Where fine-grained sediments underlay buildings, however, more attenuation is expected and observed in the database. **Thus, a semi-site-specific attenuation factor of 0.0005 may be used at sites where laterally extensive fine-grained sediment has been demonstrated through site-specific sampling to underlay buildings being investigated for vapor intrusion.**

### A.3.3 RECOMMENDED GENERIC ATTENUATION FACTOR FOR SUB-SLAB SOIL GAS

To account for the inherent temporal and spatial variability in indoor air and subsurface vapor concentrations, the 95<sup>th</sup> percentile value of the “source-screened” sub-slab data subset in EPA (2012a) is recommended as a reasonably conservative generic attenuation factor, after considering a range of values. Thus, **for sub-slab soil gas, the recommended generic attenuation factor ( $\alpha_{ss}$ ) is 0.03.**

The selection of this value can be supported by theoretical analysis. Specifically, a simple mass balance analysis, assuming a well-mixed interior volume and steady-state conditions, indicates that the theoretical (true) sub-slab soil gas attenuation factor can be expressed as the ratio of the soil gas entry rate to the building ventilation rate (Song et al., 2011; EPA 2012a) for cases where there is no background contribution to the indoor air concentration. Using median values for residential building volume and air exchange rate (395 m<sup>3</sup> and 0.45 ACH, respectively) provided in the *Exposure Factors Handbook 2011 Edition* (EPA, 2011) and a mid-range value of 5 L/min for soil gas entry rate in sandy materials (EPA 2002, Appendix G), the central tendency value of the sub-slab soil gas attenuation factor (according to Equation 4a therein), is expected to be approximately 0.002. Using upper-end (10<sup>th</sup> percentile) values for residential building volume and air exchange rate (154 m<sup>3</sup> and 0.18 ACH, respectively (EPA 2011)) and soil gas entry rate (10 L/min), an upper-end value of 0.02 for the sub-slab soil gas attenuation factor is obtained. These values agree well with the 95<sup>th</sup> percentile and 50<sup>th</sup> percentile (median) values



(0.03 and 0.003, respectively) obtained from the source-screened data. These calculations buttress the conclusion that the sub-slab attenuation factor distributions summarized in EPA's vapor intrusion database report can be considered representative of vapor intrusion of CHCs into residential buildings for most conditions.

Table A-4 (Table 10 in EPA (2012a)) provides statistics and Figure A-4 (Figure 25 in EPA (2012a)) shows box-and-whisker plots for individual sites compared with the statistics for the combined set of screened sub-slab attenuation factors. This table and figure show that the 95<sup>th</sup> percentile value of the combined sub-slab-indoor air measurements is considered appropriate for estimating reasonable maximum indoor air concentrations that might be observed at a site due to vapor intrusion. The majority of sites and buildings would be expected to exhibit lower indoor air concentrations.

### **A.3.4 RECOMMENDED ATTENUATION FACTOR FOR “NEAR-SOURCE” EXTERIOR SOIL GAS**

Based upon the conceptual model for vapor intrusion, the attenuation factors for exterior soil gas data would be expected to be less than those for sub-slab soil gas, because the former includes an additional contribution from attenuation through the vadose zone, and greater than those for groundwater vapors for a given building at a site where groundwater is the primary subsurface source of vapors. The distributions of exterior soil gas attenuation factors shown in Table A-1 and Figure A-1 do not exhibit this expected relationship. In addition, a comparison of exterior soil gas to sub-slab soil gas concentrations for buildings where both types of samples were collected, shown in Figure A-5 (see Figure 6 in EPA (2012a)), suggests that a substantial proportion of the exterior soil gas data in the database, particularly shallow soil gas data, may not be representative of soil gas concentrations directly underneath a building. On this basis, shallow exterior soil gas sampling data generally are not recommended for purposes of estimating indoor air concentrations and the exterior soil gas attenuation factors in Table A-1 are not recommended for use in deriving generic attenuation factors.

Based upon the data in Figure A-5, “deep” exterior soil gas data appear to more reliably reflect sub-slab concentrations beneath buildings. On this basis, “near-source” soil gas sampling data (i.e., collected in the vadose zone immediately above each vapor source) generally are allowed for purposes of assessing vapor concentrations that may be in contact with the building's sub-slab, as discussed further in Section 6.4.4. However, the same conservative attenuation factor value for sub-slab soil gas is recommended for use with “near-source” exterior soil gas data for this purpose. **Thus, for “near-source” exterior soil gas, the recommended generic attenuation factor is 0.03.**

### A.3.5 RECOMMENDED ATTENUATION FACTOR FOR CRAWLSPACE VAPOR

The distribution of attenuation factors presented in Figure A-1 show that attenuation between building crawlspaces and living spaces is limited. To account for the inherent temporal and spatial variability in indoor air and crawlspace vapor concentrations, the 95<sup>th</sup> percentile value of the “indoor air-screened” crawlspace data subset in EPA (2012a) is recommended as a reasonably conservative generic attenuation factor, after considering a range of values. **Thus, for crawl space vapor the recommended generic attenuation factor is 1.0** (0.9 rounded up to 1.0).

### A.3.6 RELIABILITY ANALYSIS OF THE RECOMMENDED SUBSURFACE-TO-INDOOR AIR GENERIC ATTENUATION FACTORS

An analysis was performed to determine the reliability of these recommended attenuation factors for screening in residences in EPA’s vapor intrusion data base with measured indoor air concentrations exceeding target levels corresponding to a cancer risk of  $10^{-6}$  and a hazard quotient of 1. The reliability analysis was performed separately for each medium by determining the number of correct assessments and the number of false negatives for a range of attenuation factors. The potential incidence of false negatives is a critical criterion, because the primary objective of risk-based screening is to identify sites or buildings unlikely to pose a health concern through the vapor intrusion pathway (see Section 6.5.1).

For the purposes of this analysis:

- A correct assessment is deemed to occur either: (1) when a chemical’s measured indoor air concentration exceeds the target level and the measured subsurface vapor concentration also exceeds the appropriate medium-specific VISL calculated using the specified generic attenuation factor, or (2) when a chemical’s measured indoor air concentration is below the target level and the measured subsurface vapor concentration also is below the appropriate medium-specific VISL calculated using the recommended generic attenuation factor. Correct assessments in this analysis represent a correct decision based on subsurface concentration data regarding the potential for vapor intrusion to pose indoor air concentrations that exceed target risk-based concentrations in affected buildings.
- A false negative is deemed to occur when a chemical’s measured indoor air concentration exceeds the target level, but the measured subsurface vapor concentration does not exceed the appropriate medium-specific VISL calculated using the specified generic attenuation factor. False negatives in this analysis represent the potential for making an incorrect decision based on subsurface concentration data regarding the potential for vapor intrusion to pose indoor air concentrations that exceed target risk-based concentrations in affected buildings.

This assessment uses the Data Consistency Subset of the EPA’s vapor intrusion database for residential buildings (i.e., before screening to minimize the impacts of background contributions to indoor air as described in EPA (2012a)). This subset was chosen to allow for the possibility that background indoor air contributions were incorrectly identified and removed from further analysis in the “source-screened” data subsets presented in EPA (2012a). Thus, false negatives may appear if indoor or ambient (outdoor) sources of VOCs are present and they exceed the

indoor air target level. This choice of datasets provides a conservative estimate of the frequency of false negatives identified by this reliability analysis. Even lower rates of false negatives would be obtained when considering the “source-screened” data subsets, described in EPA (2012a), in which the impacts of background contributions to indoor air are minimized.

The results of this assessment are shown in Figures A-6 through A-8 for sub-slab soil gas, groundwater, and exterior soil gas.<sup>256</sup> The essential results are as follows:

- The recommended generic attenuation factors yield low rates of false negatives (< 2%) for all three media when individual pairs of samples are evaluated together.
- The recommended generic attenuation factors for groundwater, exterior soil gas, and sub-slab soil gas provide generally high rates of correct assessments when individual pairs of samples are evaluated together: 78% for groundwater; 76% for exterior soil gas; and 87% for sub-slab soil gas. Higher rates of correct assessments are expected for sub-slab soil gas than for the other subsurface media, likely due to the closer spatial correspondence of building sub-slab soil gas and indoor air samples.
- The rates of correct assessments appear to level off in Figure A-6 through A-8 at about the point on the x-axis where the recommended generic attenuation factors occur.
- The rates of false positives using the Data Consistency Subset can be inferred from Figure A-6 through A-8. This analysis indicates that use of ground water data or exterior soil gas data is more likely to incorrectly identify a site or building as warranting further investigation than is use of sub-slab soil gas data.

Compared to the values estimated in Figures A-6 through A-8, significantly higher rates of a correct assessment (and, hence, lower rates of false negatives and false positives) are reasonably anticipated to be realized by following this Technical Guide. Specifically, collecting multiple samples to characterize spatial and temporal variability (see, for example, Section 6.4), collecting multiple lines of additional evidence (see, for example, Section 6.3 and 7.1), and weighing this information together (see, for example, Sections 6.3 and 7) are reasonably expected to significantly reduce the “error rates” estimated in this reliability analysis, which are based upon comparison of individual pairs of indoor air and subsurface sample concentrations.

As previously stated, this Technical Guide includes subsurface VISLs that are intended to help identify those sites with the potential to pose a vapor intrusion concern. The reliability analysis described above suggests the recommended attenuation factors, on which the recommended VISLs are based, can reasonably be expected to provide an acceptably small probability of ‘screening out’ sites that pose a vapor intrusion concern and a high probability of correctly identifying sites or buildings that may pose a vapor intrusion concern.

---

<sup>256</sup> The reliability assessment was not conducted for crawl space data, because the distribution of attenuation factors presented in Figure A-1 show that attenuation between building crawl spaces and living spaces is limited.

## A.4 CONSIDERATIONS FOR NONRESIDENTIAL BUILDINGS

The recommended attenuation factors (see Sections B.3.2 through B.3.5) are proposed for use for nonresidential buildings as well as residential buildings. The rationale is that, in many geographic locations, some commercial enterprises have been established in converted residential buildings. Although used for commercial purposes, such buildings can reasonably be expected to exhibit similar susceptibility to vapor intrusion and similar interior mixing and dilution (and, hence, similar attenuation factors) as residential buildings represented in EPA's vapor intrusion database. In addition, McDonald and Wertz (2007) found that sub-slab attenuation factors for commercial and institutional buildings in Endicott, New York, which were not "extraordinarily large", were not substantially different than those for residential buildings in the same area.

There are theoretical considerations to support expectations that larger nonresidential buildings that are constructed on thick slabs will have lower attenuation factors than residential buildings. These considerations include:

- Given that the size (e.g., interior height and footprint area) and air exchange rate tend to be larger for many nonresidential buildings (see, for example, Table A-5), it is expected that building ventilation rates for many nonresidential buildings would be higher than those for residential buildings. A higher ventilation rate is expected to result in greater overall vapor dilution as vapors migrate from a subsurface vapor source into a building. On this basis, many nonresidential buildings would be expected to have lower attenuation factors than those for residential buildings, all else being equal.
- Comparing buildings with slab-on-grade construction, nonresidential buildings tend to have thicker slabs than residential buildings. With thicker slabs, a given amount of differential settling would be expected to lead to less cracking in the slab and would be less likely to create cracks that extend across the entire slab thickness. Buildings with thicker slabs would, therefore, be expected to exhibit lower soil gas entry rates, all else being equal.

Where appropriate, EPA may consider appropriate building-specific data, information, and analysis when evaluating vapor intrusion into large nonresidential buildings.

## A.5 CITATIONS (APPENDIX A)

Johnson, P.C., and R.A. Ettinger. 1991. Heuristic model for predicting the intrusion rate of contaminant vapors into buildings. *Environmental Science & Technology* 25:1445-1452.

McDonald, G.J. and W.E. Wertz. 2007. PCE, TCE, and TCA vapors in subslab soil gas and indoor air: A case study in upstate New York. *Groundwater Monitoring & Remediation* 27(4):86-92.

Song, S., F. C. Ramacciotti, B. A. Schnorr, M. Bock, and C.M. Stubbs. 2011. Evaluation of EPA's empirical attenuation factor database. *EM: The Magazine for Environmental Managers* February:16-21. Currently available online at <http://pubs.awma.org/gsearch/em/2011/2/song.pdf>

U.S. Environmental Protection Agency (EPA). 2015a. *Vapor Intrusion Screening Level (VISL) Calculator, User's Guide*. Currently available online at:

<http://www.epa.gov/oswer/vaporintrusion/guidance.html>

U.S. Environmental Protection Agency (EPA). 2012a. *U.S. EPA's Vapor Intrusion Database: Evaluation and Characterization of Attenuation Factors for Chlorinated Volatile Organic Compounds and Residential Buildings*. EPA 530-R-10-002. Currently available online at [http://www.epa.gov/oswer/vaporintrusion/documents/OSWER\\_2010\\_Database\\_Report\\_03-16-2012\\_Final.pdf](http://www.epa.gov/oswer/vaporintrusion/documents/OSWER_2010_Database_Report_03-16-2012_Final.pdf)

U.S. Environmental Protection Agency (EPA). 2012b. *Conceptual Model Scenarios for the Vapor Intrusion Pathway*. EPA-530-R-10-003. Currently available online at <http://www.epa.gov/oswer/vaporintrusion/documents/vi-cms-v11final-2-24-2012.pdf>

U.S. Environmental Protection Agency (EPA). 2011. *Exposure Factors Handbook – 2011 Edition*. Office of Research and Development, Washington, D.C. EPA/600/R-090/052. Currently available online at <http://www.epa.gov/ncea/efh/pdfs/efh-complete.pdf>

U.S. Environmental Protection Agency (EPA). 2009. *Risk Assessment Guidance for Superfund (RAGS), Volume I: Human Health Evaluation Manual (Part F, Supplemental Guidance for Inhalation Risk Assessment)*. Office of Superfund Remediation and Technology Innovation, Washington, D.C. EPA-540-R-070-002. Currently available online at <http://www.epa.gov/oswer/riskassessment/ragsf/index.htm>

U.S. Environmental Protection Agency (EPA). 2002. *OSWER Draft Guidance for Evaluating the Vapor Intrusion to Indoor Air Pathway from Groundwater and Soils (Subsurface Vapor Intrusion Guidance)*. Office of Solid Waste and Emergency Response, Washington, D.C. EPA-530-D-02-004. November. Currently available online at: <http://www.epa.gov/osw/hazard/correctiveaction/eis/vapor.htm>

U.S. Environmental Protection Agency (EPA). 2001. *Fact Sheet, Correcting the Henry's Law Constant for Soil Temperature*. Office of Solid Waste and Emergency Response, Washington, D.C. Currently available online at <http://www.epa.gov/oswer/riskassessment/airmodel/pdf/factsheet.pdf>

**TABLE A-1.  
 DESCRIPTIVE STATISTICS SUMMARIZING ATTENUATION FACTOR DISTRIBUTIONS FOR GROUNDWATER,  
 EXTERIOR SOIL GAS, SUB-SLAB SOIL GAS, AND CRAWL SPACE VAPOR AFTER APPLICATION OF THE  
 DATABASE SCREENS CONSIDERED MOST EFFECTIVE AT MINIMIZING THE INFLUENCE OF BACKGROUND  
 SOURCES ON INDOOR AIR CONCENTRATIONS.**

<b>Statistic</b>	<b>Groundwater (GW &gt; 1,000X Bkgd)</b>	<b>Exterior Soil Gas (SG &gt; 50X Bkgd)</b>	<b>Sub-slab Soil Gas (SS &gt; 50X Bkgd)</b>	<b>Crawl Space (IA &gt; Bkgd)</b>
Min	1.0E-07	5.0E-06	2.5E-05	5.7E-02
5%	3.6E-06	7.6E-05	3.2E-04	1.0E-01
25%	2.3E-05	6.0E-04	1.5E-03	2.2E-01
50%	7.4E-05	3.8E-03	2.7E-03	3.9E-01
75%	2.0E-04	2.7E-02	6.8E-03	6.9E-01
95%	1.2E-03	2.5E-01	2.6E-02	9.0E-01
Max	2.1E-02	1.3E+00	9.4E-01	9.2E-01
Mean	2.8E-04	5.0E-02	9.2E-03	4.6E-01
StdDev	1.0E-03	1.7E-01	5.0E-02	2.8E-01
95UCL	3.4E-04	7.8E-02	1.3E-02	5.3E-01
Count All	774	106	431	41
Count >RL	743	106	411	41
Count <RL	31	0	20	0
No. of sites	24	11	12	4

Note: The applied database screens are groundwater (vapor) concentrations > 1,000X "background," exterior soil gas > 50X "background," sub-slab soil gas > 50X "background," and for crawl space, indoor air concentrations > 1X "background." SOURCE: Table 19 in EPA (2012a).

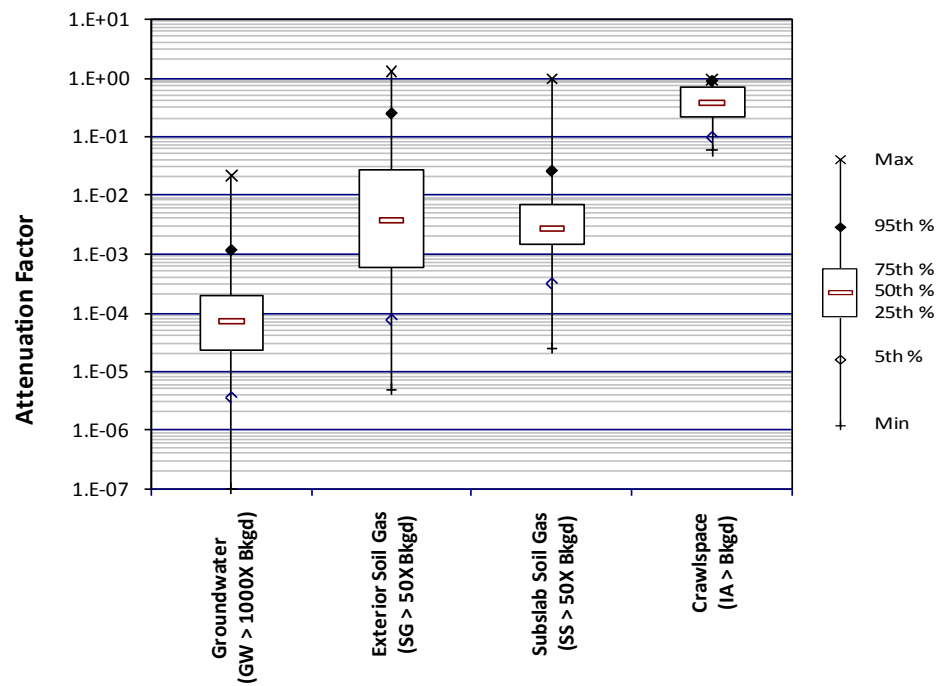


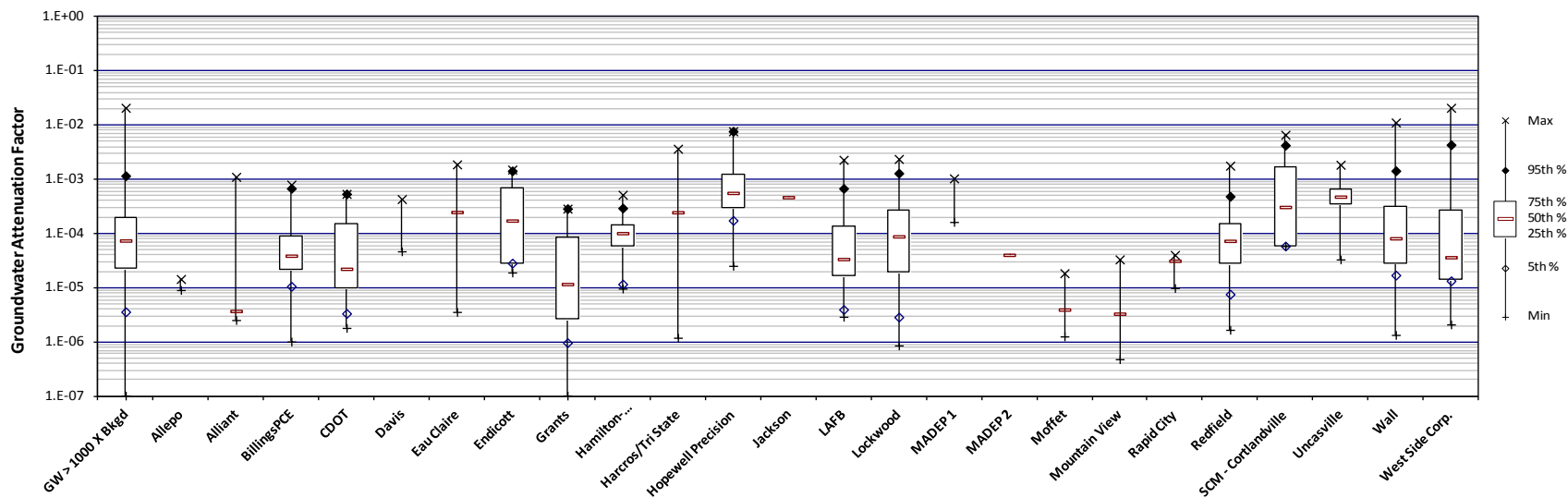
Figure A-1. Box-and-whisker plots summarizing attenuation factor distributions for groundwater, exterior soil gas, sub-slab soil gas, and crawlspace vapor after application of the database screens considered most effective at minimizing the influence of background sources on indoor air concentrations. SOURCE: Figure 34 in EPA (2012a).

**TABLE A-2.  
DESCRIPTIVE STATISTICS SUMMARIZING GROUNDWATER ATTENUATION FACTOR DISTRIBUTIONS FOR  
INDIVIDUAL SITES COMPARED WITH THE COMBINED DATA SET AFTER SOURCE STRENGTH SCREEN  
(GROUNDWATER VAPOR CONCENTRATIONS > 1,000 TIMES "BACKGROUND").**

Statistic	GW > 1,000 X Bkgd	Allepo	Alliant	BillingsPCE	CDOT	Davis	Eau Claire	Endicott	Grants	Hamilton-Sundstrand	Harcros/TriState	HopewellPrecision	Jackson	LAFB	Lockwood	MADEP 1	MADEP 2	Moffet	Mountain View	Rapid City	Redfield	SCM - Cortlandville	Uncasville	Wall	West Side Corp.
Min	1.0E-07	9.1E-06	2.5E-06	1.0E-06	1.8E-06	4.7E-05	3.6E-06	1.9E-05	1.0E-07	9.6E-06	1.2E-06	2.5E-05		2.9E-06	8.6E-07	1.6E-04		1.3E-06	4.8E-07	9.9E-06	1.7E-06	5.9E-05	3.3E-05	1.4E-06	2.1E-06
5%	3.6E-06			1.1E-05	3.4E-06			2.8E-05	9.7E-07	1.2E-05		1.7E-04		4.0E-06	2.9E-06						7.6E-06	5.9E-05		1.7E-05	1.3E-05
25%	2.3E-05			2.1E-05	9.9E-06			2.8E-05	2.7E-06	5.8E-05		2.9E-04		1.7E-05	1.9E-05						2.8E-05	5.9E-05	3.5E-04	2.9E-05	1.5E-05
50%	7.4E-05		3.7E-06	3.9E-05	2.2E-05		2.5E-04	1.7E-04	1.2E-05	1.0E-04	2.5E-04	5.6E-04	4.7E-04	3.4E-05	8.8E-05		4.0E-05	4.0E-06	3.3E-06	3.1E-05	7.3E-05	3.1E-04	4.8E-04	8.2E-05	3.7E-05
75%	2.0E-04			8.9E-05	1.5E-04			7.0E-04	8.7E-05	1.5E-04		1.2E-03		1.4E-04	2.7E-04						1.5E-04	1.7E-03	6.5E-04	3.2E-04	2.7E-04
95%	1.2E-03			6.8E-04	5.4E-04			1.4E-03	2.9E-04	2.9E-04		7.7E-03		6.8E-04	1.3E-03						4.8E-04	4.2E-03		1.4E-03	4.3E-03
Max	2.1E-02	1.4E-05	1.1E-03	8.0E-04	5.4E-04	4.3E-04	1.9E-03	1.5E-03	2.9E-04	5.2E-04	3.7E-03	7.7E-03		2.3E-03	2.4E-03	1.0E-03		1.9E-05	3.3E-05	4.0E-05	1.8E-03	6.6E-03	1.8E-03	1.1E-02	2.1E-02
Mean	2.8E-04		1.1E-04	1.2E-04	1.1E-04	2.4E-04	7.7E-04	4.3E-04	7.5E-05	1.2E-04	7.1E-04	1.2E-03		1.6E-04	2.6E-04	6.0E-04		7.9E-06	9.7E-06	2.7E-05	1.3E-04	1.1E-03	6.0E-04	4.9E-04	1.1E-03
StdDev	1.0E-03		3.4E-04	2.1E-04	1.7E-04		8.1E-04	4.8E-04	1.1E-04	9.8E-05	1.3E-03	1.8E-03		3.6E-04	4.5E-04			9.3E-06	1.4E-05	1.6E-05	1.9E-04	1.6E-03	5.1E-04	1.7E-03	4.0E-03
95UCL	3.4E-04		2.8E-04	1.9E-04	1.8E-04		1.4E-03	5.7E-04	1.2E-04	1.5E-04	1.7E-03	2.0E-03		2.2E-04	3.5E-04			2.4E-05	2.3E-05	5.4E-05	1.5E-04	1.6E-03	9.2E-04	9.2E-04	2.3E-03
Count All	774	2	12	25	17	2	6	32	14	32	7	17	1	93	63	2	1	3	5	3	329	28	9	43	28
Count >RL	743	1	5	25	17	2	6	22	14	32	7	17	1	93	63	2	1	3	5	3	329	21	9	43	22
Count <RL	31	1	7	0	0	0	0	10	0	0	0	0	0	0	0	0	0	0	0	0	0	7	0	0	6

SOURCE: Table 13 in EPA (2012a).



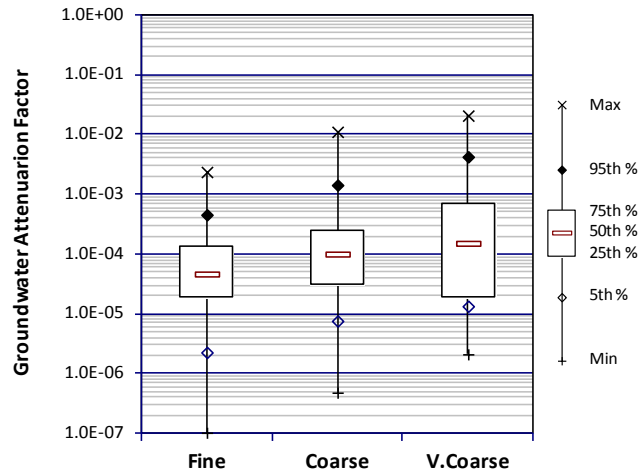


**Figure A-2. Box-and-whisker plots summarizing groundwater attenuation factor distributions for individual sites compared with the combined data set after Source Strength Screen (groundwater vapor concentrations > 1,000 times “background”).** SOURCE: Figure 28 in EPA (2012a).

**TABLE A-3.  
DESCRIPTIVE STATISTICS SUMMARIZING GROUNDWATER ATTENUATION FACTOR DISTRIBUTIONS FOR  
SPECIFIC SOIL TYPES AFTER SOURCE STRENGTH SCREEN.**

Statistic	Soil Type Below Foundation		
	Fine	Coarse	V.Coarse
Min	1.0E-07	4.8E-07	2.1E-06
5%	2.3E-06	7.6E-06	1.3E-05
25%	1.9E-05	3.1E-05	2.0E-05
50%	4.6E-05	1.0E-04	1.5E-04
75%	1.4E-04	2.5E-04	6.8E-04
95%	4.5E-04	1.4E-03	4.2E-03
Max	2.4E-03	1.1E-02	2.1E-02
Mean	1.3E-04	3.3E-04	9.7E-04
StdDev	2.4E-04	8.9E-04	3.0E-03
95UCL	1.5E-04	4.1E-04	1.7E-03
Count All	353	369	52
Count >RL	344	359	40
Count <RL	9	10	12
No. of sites	10	15	3

SOURCE: Table 14 in EPA (2012a).



**Figure A-3. Box-and-whisker plots summarizing groundwater attenuation factor distributions for specific soil types after Source Strength Screen.** SOURCE: Figure 29 in EPA (2012a).

**TABLE A-4.  
DESCRIPTIVE STATISTICS SUMMARIZING SUB-SLAB ATTENUATION FACTOR DISTRIBUTIONS FOR INDIVIDUAL SITES COMPARED WITH THE COMBINED DATA SET AFTER SOURCE STRENGTH SCREEN (SUB-SLAB SOIL GAS CONCENTRATIONS > 50 TIMES “BACKGROUND”).**

Statistic	SS > 50X Bkgd	BillingsPCE	DenverPCEBB	Endicott	Georgetown	Harcros/Tri State	Hopewell Precision	Jackson	LAFB	Orion Park	Raymark	SCM-Cortlandville	West Side Corporation
Min	2.5E-05	2.5E-05	1.1E-03	2.6E-04	1.3E-03	3.8E-04	1.5E-03		3.5E-05	5.0E-04	2.5E-04	3.4E-03	2.0E-04
5%	3.2E-04	9.6E-05		6.9E-04			1.9E-03		1.4E-04		1.2E-03	3.6E-03	
25%	1.5E-03	4.6E-04		1.7E-03			5.0E-03		4.1E-04	1.8E-03	2.0E-03	7.1E-03	5.9E-04
50%	2.7E-03	7.0E-04	6.4E-03	2.6E-03	1.9E-03	4.5E-04	1.0E-02	8.4E-03	1.9E-03	2.8E-03	5.5E-03	1.8E-02	1.5E-03
75%	6.8E-03	1.5E-03		5.0E-03			1.8E-02		5.3E-03	8.8E-03	8.3E-03	4.1E-02	9.7E-03
95%	2.6E-02	2.6E-03		1.1E-02			3.4E-02		3.2E-02		2.1E-02	1.5E-01	
Max	9.4E-01	2.7E-03	4.1E-02	9.4E-01	2.9E-03	2.7E-03	3.4E-02		4.2E-02	3.3E-02	7.9E-02	1.5E-01	3.5E-01
Mean	9.2E-03	9.5E-04	1.7E-02	8.5E-03	2.0E-03	1.0E-03	1.3E-02	8.4E-03	5.0E-03	7.6E-03	7.4E-03	4.1E-02	4.3E-02
StdDev	5.0E-02	7.7E-04	1.9E-02	6.5E-02	8.4E-04	1.1E-03	1.0E-02		9.0E-03	1.1E-02	1.0E-02	5.0E-02	1.2E-01
95UCL	1.3E-02	1.2E-03	3.5E-02	1.6E-02	3.5E-03	2.3E-03	1.7E-02		7.1E-03	1.4E-02	9.2E-03	6.8E-02	1.2E-01
No. of AFs	431	27	5	207	3	4	19	1	52	9	83	12	9
No. of AFs > RL	411	27	5	188	3	4	19	1	52	9	83	12	8
No. of AFs < RL	20	0	0	19	0	0	0	0	0	0	0	0	1

SOURCE: Table 10 in EPA (2012a).

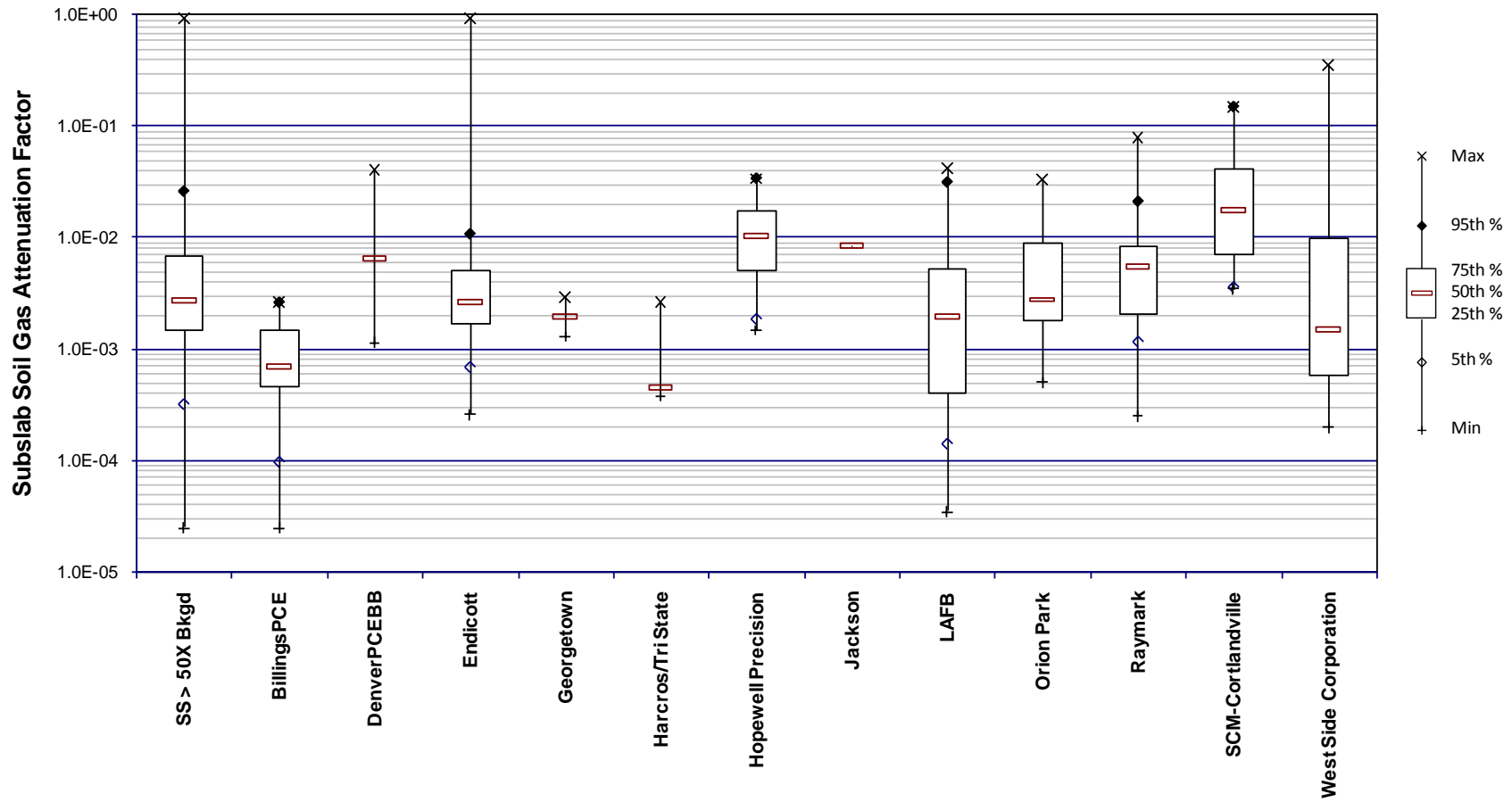
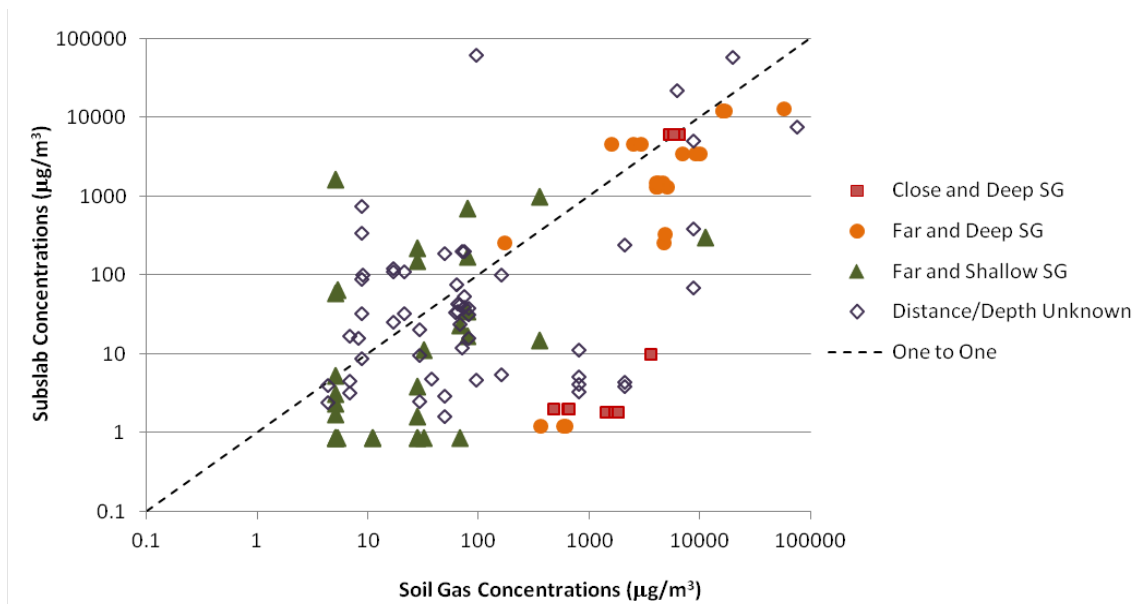


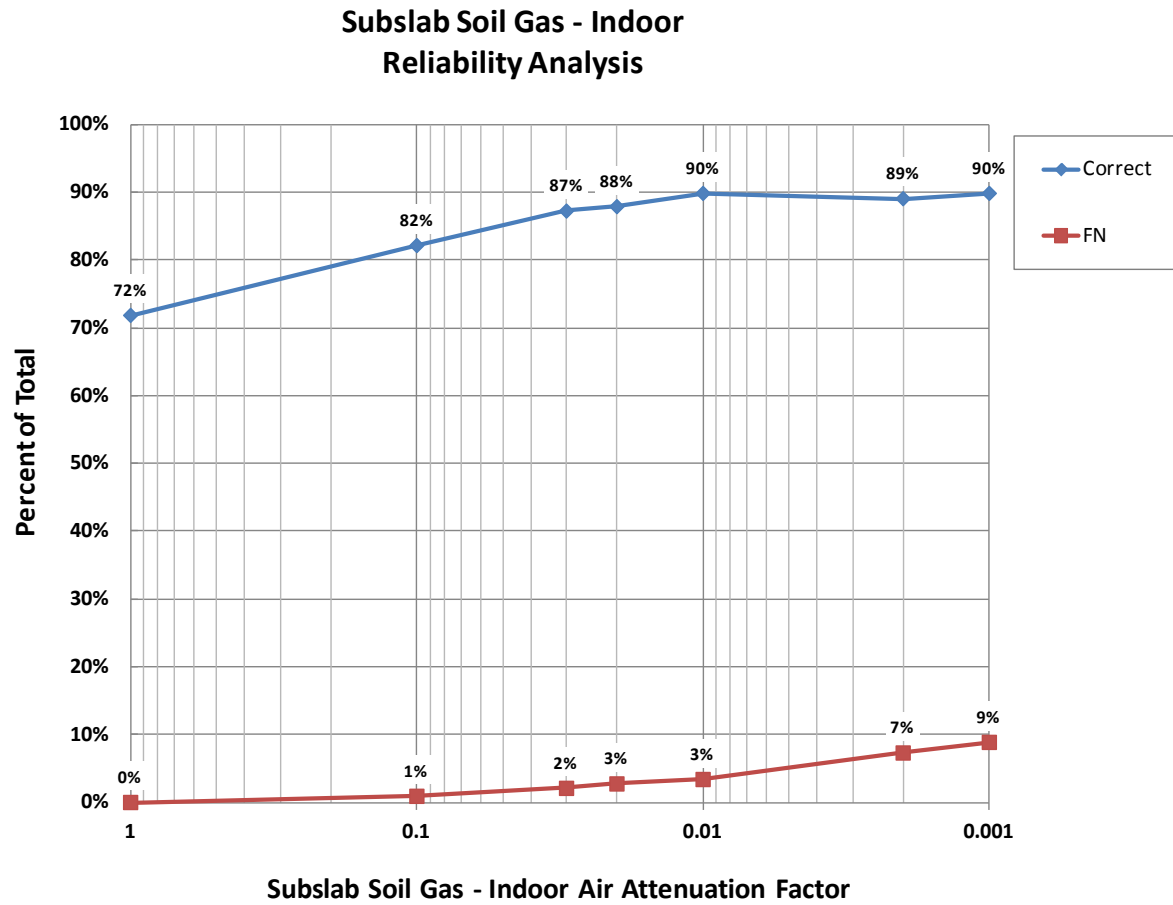
Figure A-4. Box-and-whisker plots summarizing sub-slab soil gas attenuation factor distributions for individual sites after Source Strength Screen (sub-slab soil gas concentrations > 50 times “background”). SOURCE: Figure 25 in EPA (2012a).

**TABLE A-5**  
**COMPARISON OF SIZE CHARACTERISTICS FOR RESIDENTIAL AND SOME COMMERCIAL BUILDINGS**

Building Parameter and Units	Value and Source for Residential Building	Value and Source for Commercial Buildings, Other Than Warehouses and Enclosed Malls
ACH <sub>Bldg</sub> (1/hr), 10 <sup>th</sup> percentile	0.18 (EPA 2011, Table 19-1)	0.6 (EPA 2011, Table 19-27)
H <sub>Bldg</sub> (feet)	8-foot ceiling height (EPA 2011, assumed value)	12-foot ceiling height (EPA 2011, assumed value)



**Figure A-5. Exterior soil gas versus sub-slab soil gas concentrations for buildings with both types of data in EPA’s vapor intrusion database differentiated qualitatively by horizontal distance to building and depth to the exterior soil gas sample. SOURCE: Figure 6 in EPA (2012a).**



**Figure A-6. Reliability Predictions for Alternative Choices of the Sub-slab Attenuation Factor Based on a Comparison of Paired Data in the Data Consistency Screen Dataset [tabulated values shown below]**

Reliability Analysis: Subslab Soil Gas - Indoor Air							
Classification	SS AF = 1	SS AF = 0.1	SS AF = 0.03	SS AF = 0.02	SS AF = 0.01	SS AF = 0.002	SS AF = 0.001
Correct	551	630	669	674	689	683	689
FN	0	7	16	21	26	56	68
Total	767	767	767	767	767	767	767
SS AF	1	0.1	0.03	0.02	0.01	0.002	0.001
Correct	72%	82%	87%	88%	90%	89%	90%
FN	0%	1%	2%	3%	3%	7%	9%

### Groundwater - Indoor Air Reliability Analysis

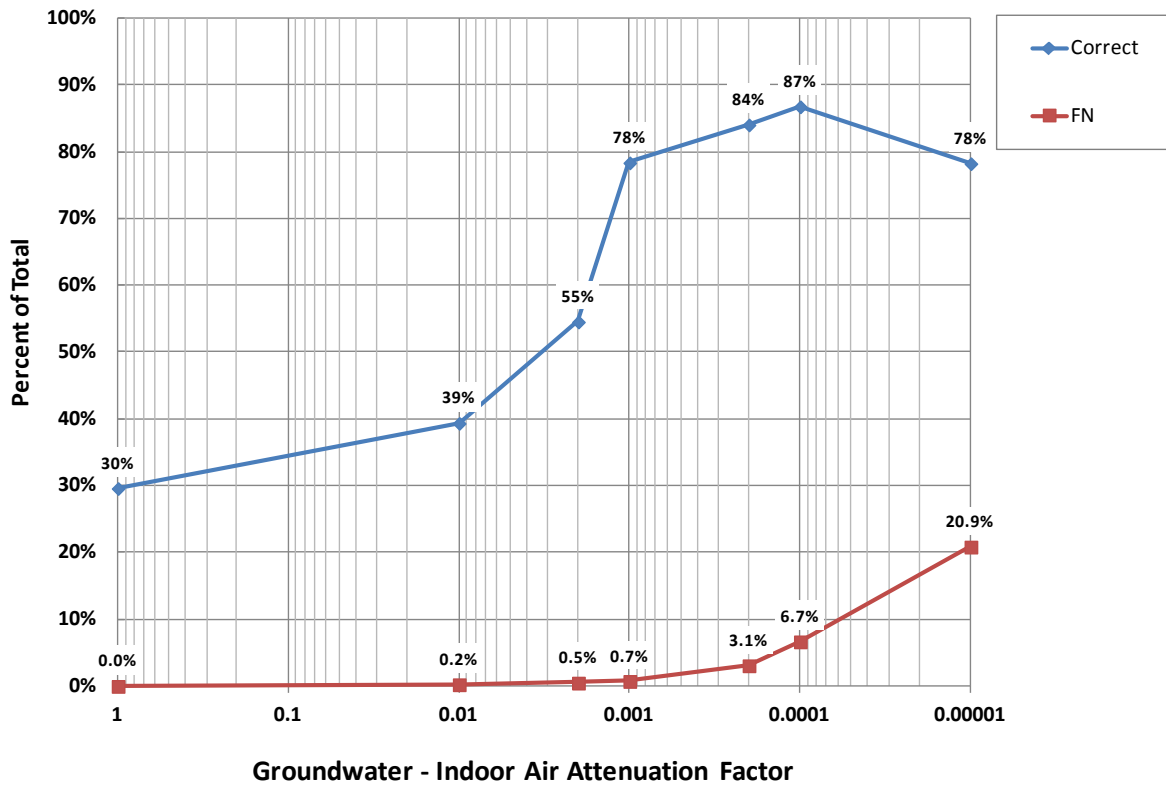
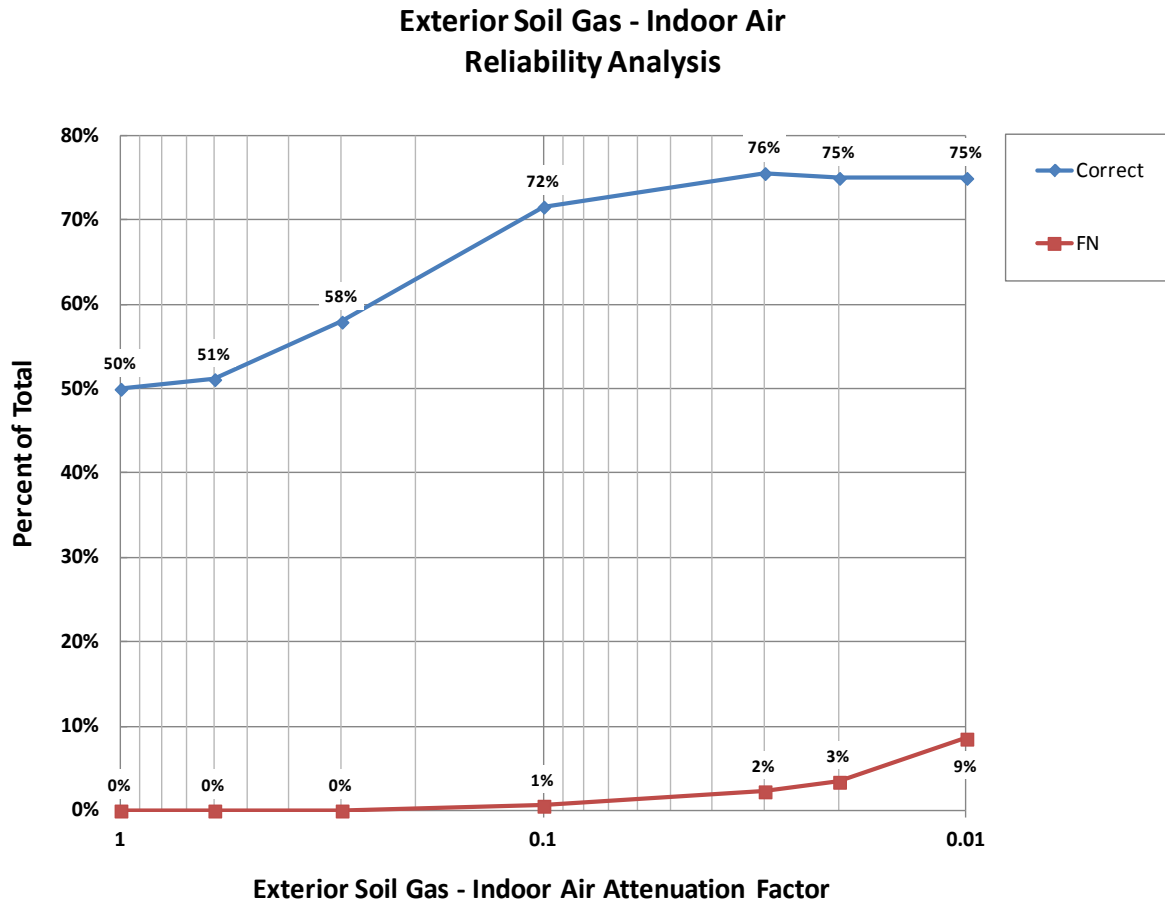


Figure A-7. Reliability Predictions for Alternative Choices of the Groundwater Attenuation Factor Based on a Comparison of Paired Data in the Data Consistency Screen Dataset [tabulated values shown below]

Reliability Analysis: Groundwater -Indoor Air							
Classification	GW AF = 1	GW AF = 0.01	GW AF = 0.002	GW AF = 0.001	GW AF = 0.0002	GW AF = 0.0001	GW AF = 0.00001
Correct	240	319	442	635	681	703	634
FN	0	2	4	6	25	54	169
Total	810	810	810	810	810	810	810
GW AF	1	0.01	0.002	0.001	0.0002	0.0001	0.00001
Correct	30%	39%	55%	78%	84%	87%	78%
FN	0.0%	0.2%	0.5%	0.7%	3.1%	6.7%	20.9%





**Figure A-8. Reliability Predictions for Alternative Choices of the Exterior Soil Gas Attenuation Factor Based on a Comparison of Paired Data in the Data Consistency Screen Dataset**  
[tabulated values shown below]

Reliability Analysis: Exterior Soil Gas - Indoor Air							
Classification	SG AF = 1	SG AF = 0.6	SG AF = 0.3	SG AF = 0.1	SG AF = 0.03	SG AF = 0.02	SG AF = 0.01
Correct	88	90	102	126	133	132	132
FN	0	0	0	1	4	6	15
Total	176	176	176	176	176	176	176
SG AF	1	0.6	0.3	0.1	0.03	0.02	0.01
Correct	50%	51%	58%	72%	76%	75%	75%
FN	0%	0%	0%	1%	2%	3%	9%

## APPENDIX B DATA QUALITY ASSURANCE CONSIDERATIONS

### B.1 INTRODUCTION

Site-specific investigations of the vapor intrusion pathway will generally entail the collection and evaluation of environmental data and possibly the use of modeling. As noted in Exhibit B-1, EPA generally recommends the use of a quality assurance project plan (QAPP) for the collection of primary (and existing or secondary) data. A QAPP is a tool for project managers and planners to document the type and quality of data needed to make environmental decisions and to describe the methods for collecting and assessing the quality and integrity of those data. A QAPP is a plan or roadmap intended to help a project team document how they plan, implement, and evaluate a project. It applies the systematic planning process and the graded approach for collecting environmental data for a specific intended use. EPA standards governing the collection of data are outlined in Exhibit B-1.

#### Exhibit B-1. EPA Data Standards

CIO 2105 (formerly EPA Order 5360; *Policy and Program Requirements for the Agency-wide Quality System*, May 2000) is intended to promote the organization collecting or using the data to (1) establish a Quality System and prepare and approve a QAPP for each project.

For clarity, CIO 2105 will be replaced by the following two standards:

- CIO 2106-S-01 is the *Quality Standard for Environmental Data Collection, Production, and Use by EPA Organizations*, also called “Internal Standard” (EPA 2013a); and
- CIO 2106-S-02 is the *Quality Standard for Environmental Data Collection, Production, and Use by Non-EPA (External) Organizations*, also called “External Standard” (EPA 2013b).

These standards conform to *EPA Quality Policy*, CIO 2106.0, “Quality Policy” (EPA 2008a), *Procedure for Quality Policy*, CIO 2106-P-01.0, “Quality Procedure” (EPA 2008b), and the American National Standards Institute (ANSI) consensus standard, *Quality Systems for Environmental Data and Technology Programs – Requirements with Guidance for Use* (ANSI/ASQ 2004).

Two guidance documents accompany these standards:

- *EPA Guidance on Quality Management Plans* (EPA 2012b, CIO 2106-G02-QMP), documents the quality system of the organization conducting environmental data collection or using the data for EPA.
- *EPA Guidance on Quality Assurance Project Plans* (EPA 2012a, CIO 2106-G-05) focuses on projects requiring the collection of new data, projects using existing data, and projects involving modeling.

EPA also encourages the use of the *Uniform Federal Policy for Quality Assurance Project Plans (UFP-QAPP)* (EPA/DoD 2005) as a collaborative approach to fulfill the purposes of a QAPP, especially for Federal Facilities. OSWER Directive 9272.0-17, *Implementation of the Uniform Federal Policy for Quality Assurance Project Plans (UFP-QAPP) at Federal Facility Hazardous Waste Sites* (EPA 2005a) and OSWER Directive 9272.0-20 (EPA 2005b) state that QAPPs prepared and approved under the UFP conform to EPA's quality standards and are consistent with EPA Standards CIO 2106-S-0 and CIO 2106-S-02, EPA's Quality Policy (EPA 2008a), and ANSI/ASQ 2004.

## B.2 RECOMMENDATIONS

This appendix provides two recommendations concerning the key components of QAPP development. These recommendations are not exhaustive, but are included as a starting point as considerations before studying or applying EPA or UFP QAPP guidance.

Recommendation 1: Using the conceptual site model (CSM), develop the project plan and QAPP through a process that involves all key players and share these materials with interested parties in draft form so that potential study weaknesses can be addressed early. The CSM is developed to portray the current understanding of site conditions, the nature and extent of contamination, routes of contaminant transport, potential contaminant pathways, and potentially exposed human population. Developing the CSM is the first step in EPA's DQO process.

Recommendation 2: Use systematic planning in developing project documents, including the QAPP. Systematic planning is a science-based, common-sense approach designed to ensure that the level of documentation and rigor of effort in planning is commensurate with the intended use of the information and available resources. DQOs are a key component of systematic planning and play a central role in the systematic planning process. DQOs generally are addressed within the QAPP and typically are a critical element in the planning for environmental investigations. *Guidance on Systematic Planning Using the Data Quality Objectives Process (QA/G-4)* (EPA 2006) provides guidance addressing implementation of DQOs and application of systematic planning to generate performance and acceptance criteria for collecting environmental data.

Table B-1 summarizes the steps in the DQO process, the purpose of each step, and provides some examples of how plans could be structured.

**TABLE B-1. EXAMPLE OF STEPS IN THE DQO PROCESS**

<b>DQO Step</b>	<b>Purpose of the DQO Step</b>	<b>Example Application for Vapor Intrusion</b>
1. State the Problem	Summarize the problem (e.g., the monitoring hypothesis, the investigation objective(s)) for which new environmental data will be collected or modeling or analysis will be performed.	Indoor air in one or more buildings overlying a shallow plume of PCE-contaminated groundwater is (are) to be sampled to determine whether PCE is present. The original PCE release occurred at an industrial site approximately 1,000 feet away from the closest building.
2. Identify the Decision	Identify the decision that will be supported by the new data, modeling or analysis.	The data will be used to support decisions about whether additional indoor air sampling or preemptive vapor intrusion mitigation will be pursued in one or more buildings.
3. Identify the Inputs to the Decision	Identify the information needed to support the decision, including data gaps that warrant collection of new information.	Indoor air sampling data for one or more buildings, in conjunction with information about measured or interpolated concentrations in groundwater near or underneath the building(s).
4. Define the Boundaries of the Study	Specify the spatial and temporal aspects of the environmental media or endpoints that the data are to represent to support the decision.	The boundaries of this initial study area extend a prescribed distance outside the lateral extent of the plume. Eventually, the boundaries of a vapor intrusion impact zone will be defined by the extent to which indoor air contamination can be associated with site-related contamination.
5. Develop a Decision Rule	Develop a logical "if...then" statement that defines the conditions that will inform the decision-maker to choose among alternative decisions.	Buildings with detectable concentrations of PCE in indoor air samples will be considered for additional indoor air sampling or preemptive vapor intrusion mitigation.
6. Specify Tolerable Limits on Decision Errors	Specify acceptable limits on decision errors, which are used to establish performance goals for limiting uncertainty in the analysis.	EPA recommends analytical limits of detection be less than risk-based screening levels for PCE to ensure that a building's indoor air concentration is not misidentified.
7. Optimize the Design for Obtaining Data	Identify the most resource-effective sampling and analysis design for generating the information needed to satisfy the DQOs.	Time-integrated samples will be collected in basements and in the first above-ground level of each building. The sampling and analysis plan and approach will be documented in a QAPP.

### B.3 CITATIONS AND REFERENCES (APPENDIX B)

ANSI/ASQ. 2004. *Quality Systems for Environmental Data and Technology Programs – Requirements with Guidance for Use*. E4-2004. Currently available for purchase online at <http://webstore.ansi.org/FindStandards.aspx?SearchString=ansi+e4&SearchOption=0&PageNum=0&SearchTermsArray=null|ansi+e4|null>

U.S. Environmental Protection Agency (EPA). 2000. *Policy and Program Requirements for the Agency-wide Quality System*. CIO 2105. May. Currently available online at <http://www.epa.gov/irmpoli8/policies/21050.pdf>

U.S. Environmental Protection Agency (EPA). 2005a. *Implementation of the Uniform Federal Policy for Quality Assurance Project Plans (UFP-QAPP) at Federal Facility Hazardous Waste Sites*. OSWER Directive 9272.0-17. June 7. Currently available online at [http://www.epa.gov/fedfac/pdf/oswer\\_qapp\\_directive.pdf](http://www.epa.gov/fedfac/pdf/oswer_qapp_directive.pdf)

U.S. Environmental Protection Agency (EPA). 2005b. *Applicability of the Uniform Federal Policy for Quality Assurance project Plans*. EPA-505-04-900A, OSWER Directive 9272.0-20. December 5. Currently available online at [http://www.epa.gov/fedfac/pdf/oswer\\_9272.0\\_20.pdf](http://www.epa.gov/fedfac/pdf/oswer_9272.0_20.pdf)

U.S. Environmental Protection Agency (EPA). 2006. *Guidance on Systematic Planning Using the Data Quality Objectives Process (QA/G-4)*. EPA-240-B-06-001. February. Currently available online at <http://www.epa.gov/quality/qs-docs/g4-final.pdf>

U.S. Environmental Protection Agency (EPA). 2008a. *U.S. Environmental Protection Agency Quality Policy*. CIO 2106.0. Currently available online at <http://www.epa.gov/irmpoli8/policies/21060.pdf>

U.S. Environmental Protection Agency (EPA). 2008b. *U.S. Environmental Protection Agency Procedure for Quality Policy*. CIO 2106-P-01.0. Currently available online at <http://www.epa.gov/irmpoli8/policies/21060.pdf>

U.S. Environmental Protection Agency (EPA). 2012a. *U.S. Environmental Protection Agency Guidance on Quality Assurance Project Plans*. CIO 2106-G-05 QAPP. January 17.

U.S. Environmental Protection Agency (EPA), 2012b. *EPA Draft Final Guidance on Quality Management Plans*. CIO 2106-G02-QMP. January 17. Currently available online at <http://www.epa.gov/oeitribalcoordination/2106-G-05%20QAPP%20Final%20Draft%2001-17-12.pdf>

U.S. Environmental Protection Agency (EPA). 2013a. *Quality Standard for Environmental Data Collection, Production, and Use by EPA Organizations*. CIO 2106-S-01.

U.S. Environmental Protection Agency (EPA). 2013b. *Draft Final Quality Standard for Environmental Data Collection, Production, and Use by Non-EPA (External) Organizations*. "External Standard." CIO 2106-S-02. February 22. Currently available online at <http://www.regulations.gov/#!documentDetail;D=EPA-HQ-OEI-2012-0774-0002>

U.S. Environmental Protection Agency and U.S. Department of Defense (EPA/DoD). 2005. *Uniform Federal Policy for Quality Assurance Project Plans (UFP-QAPP). Part 1: UFP-QAPP Manual*. EPA-505-B-04-900A, DTIC ADA 427785. March. Currently available online at <http://www2.epa.gov/fedfac/uniform-federal-policy-quality-assurance-project-plans-evaluating-assessing-and-documenting>

## APPENDIX C CALCULATING VAPOR SOURCE CONCENTRATION FROM GROUNDWATER SAMPLING DATA

### Correcting the Henry's Law Constant for Groundwater Temperature

In the case of groundwater as the vapor source, the subsurface source concentration ( $C_{sv}$ ) is estimated assuming that the vapor and aqueous phases are in local equilibrium according to Henry's law such that:

$$C_{sv} = H'_{TS} \times C_w \quad \text{Equation C.1}$$

where:

$C_{sv}$  = vapor concentration at the source of contamination ( $\text{g}/\text{cm}^3\text{-v}$ ),

$H'_{TS}$  = Henry's law constant at the system (groundwater) temperature (dimensionless), and

$C_w$  = concentration of volatile chemical in groundwater ( $\text{g}/\text{cm}^3\text{-w}$ ).

The Henry's law constants generally are reported for a temperature of 25 degrees Celsius ( $^{\circ}\text{C}$ ). **Table C-1** provides these values for the chlorinated hydrocarbons (CHCs) in the vapor intrusion database. Average groundwater temperatures, however, are typically less than  $25^{\circ}\text{C}$ . In such cases, use of the Henry's law constant at  $25^{\circ}\text{C}$  may over-predict the volatility of the contaminant in water.

As described in EPA's *Soil Screening Guidance* (EPA 1996), the dimensionless form of the Henry's law constant at the average groundwater temperature ( $H'_{gw}$ ) may be estimated using the Clapeyron equation:

$$H'_{gw} = \frac{\exp\left[-\frac{\Delta H_{v, gw}}{R_c} \times \left(\frac{1}{T_{gw}} - \frac{1}{T_R}\right)\right] H_R}{R \times T_{gw}} \quad \text{Equation C.2}$$

where:

$\Delta H_{v, gw}$  = enthalpy of vaporization of the specific chemical at the groundwater temperature ( $\text{cal}/\text{mol}$ ),

$T_{gw}$  = groundwater temperature ( $^{\circ}\text{K} = ^{\circ}\text{C} + 273.15$ ),

$T_R$  = reference temperature for the Henry's law constant ( $298.15^{\circ}\text{K}$ ),

$R_c$  = gas constant ( $= 1.9872 \text{ cal}/\text{mol}\text{-}^{\circ}\text{K}$ ),

$H_R$  = Henry's law constant for the specific substance at the reference temperature ( $\text{atm}\text{-m}^3/\text{mol}$ ), and

$R$  = gas constant ( $= 8.205 \text{ E-}05 \text{ atm}\text{-m}^3/\text{mol}\text{-}^{\circ}\text{K}$ ).

The enthalpy of vaporization at the groundwater temperature can be approximated from the enthalpy of vaporization at the normal boiling point, as follows:

$$\Delta H_{v, gw} = \Delta H_{v, b} \left[ \frac{(1 - T_{gw} / T_C)}{(1 - T_B / T_C)} \right]^\eta$$

Equation C.3

where:

$\Delta H_{v, gw}$  = enthalpy of vaporization at the groundwater temperature (cal/mol),

$\Delta H_{v, b}$  = enthalpy of vaporization at the normal boiling point (cal/mol),

$T_C$  = critical temperature for specific chemical (°K),

$T_B$  = normal boiling point for specific chemical (°K),

$\eta$  = exponent (unitless), and

all other symbols are as defined previously. **Table C-1** provides the chemical-specific property values used for temperature corrections to the Henry's law constant. **Table C-2** provides the value of  $\eta$  as a function of the ratio  $T_B/T_C$ . If site-specific data are not readily available for the groundwater temperature, then Figure 1 of the EPA fact sheet, *Correcting the Henry's Law Constant for Soil Temperature* (EPA 2001) can be used to generate an estimate.

### Citations (Appendix C)

U.S. Environmental Protection Agency (EPA). 1996. *Soil Screening Guidance: Technical Background Document*. Office of Solid Waste and Emergency Response, Washington, D.C. EPA-540-R-95-128. Currently available online at: <http://www.epa.gov/superfund/health/conmedia/soil/introtbd.htm>

U.S. Environmental Protection Agency (EPA). 2001. *Fact Sheet, Correcting the Henry's Law Constant for Soil Temperature*. Office of Solid Waste and Emergency Response, Washington, D.C. Currently available online at <http://www.epa.gov/oswer/riskassessment/airmodel/pdf/factsheet.pdf>

U.S. Environmental Protection Agency (EPA). Regions 3, 6, and 9. 2011. *Regional Screening Levels for Chemical Contaminants at Superfund Sites*. Region 3, Philadelphia, PA. November. Currently available online at [http://www.epa.gov/reg3hwmd/risk/human/rb-concentration\\_table/index.htm](http://www.epa.gov/reg3hwmd/risk/human/rb-concentration_table/index.htm)



Lide, D.R. (Ed.). 1998. *CRC Handbook of Chemistry and Physics, 79th Ed.* Boca Raton, FL. CRC Press.

Mallard, W.G. and P.J. Linstrom (Eds.). 1998. *NIST Chemistry WebBook: NIST Standard Reference Database Number 69.* Gaithersburg, MD. National Institute of Standards and Technology. November. Currently available online at <http://webbook.nist.gov/chemistry/>

**Table C-1. Chemical-Specific Parameters for Adjusting Henry's Law Coefficients for Groundwater Temperature**

Chemical Abstracts Service Registry Number (CASRN)	Alphabetized List of Compounds	Henry's Law Constant @25°C		Henry's Law Constant @25°C <sup>g</sup>	Normal Boiling Point		Critical Temperature		Enthalpy of vaporization at the normal boiling point	
		H <sub>R</sub>		H' <sub>R</sub>	T <sub>b</sub>		T <sub>c</sub>		ΔH <sub>v,b</sub>	
		(atm·m <sup>3</sup> /mol)	source	(unitless)	(°K)	source	(°K)	source	(cal/mol)	source
56-23-5	Carbon tetrachloride	2.76E-02	a	1.13E+00	3.50E+02	b	5.57E+02	h	7.13E+03	h
75-00-3	Chloroethane (ethyl chloride)	1.11E-02	a	4.54E-01	2.85E+02	b	4.60E+02	f	5.88E+03	f
67-66-3	Chloroform	3.67E-03	a	1.50E-01	3.34E+02	b	5.36E+02	h	6.99E+03	h
75-34-3	Dichloroethane,1,1-	5.62E-03	a	2.30E-01	3.30E+02	b	5.23E+02	h	6.90E+03	h
75-35-4	Dichloroethene, 1,1-	2.61E-02	a	1.07E+00	3.05E+02	b	5.76E+02	h	6.25E+03	h
156-59-2	Dichloroethene,cis-1,2-	4.08E-03	a	1.67E-01	3.28E+02	b	5.44E+02	h	7.19E+03	h
156-60-5	Dichloroethene,trans-1,2-	4.08E-03	a	1.67E-01	3.28E+02	b	5.17E+02	h	6.72E+03	h
75-09-2	Methylene chloride	3.25E-03	a	1.33E-01	3.13E+02	b	5.10E+02	h	6.71E+03	h
127-18-4	Tetrachloroethylene	1.77E-02	a	7.23E-01	3.94E+02	b	6.20E+02	h	8.29E+03	h
76-13-1	Trichloro-1,2,2-trifluoroethane,1,1,2-	5.26E-01	a	2.15E+01	3.21E+02	b	4.87E+02	f	6.46E+03	f
71-55-6	Trichloroethane, 1,1,1-	1.72E-02	a	7.03E-01	3.47E+02	b	5.45E+02	h	7.14E+03	h
79-01-6	Trichloroethylene	9.85E-03	a	4.03E-01	3.60E+02	b	5.44E+02	h	7.51E+03	h
75-01-4	Vinyl chloride (chloroethylene)	2.78E-02	a	1.14E+00	2.60E+02	b	4.32E+02	h	5.25E+03	h

Sources and Footnotes:

- a Based on values reported in the U.S. EPA Regional Screening Tables. November 2011. Available online at: [http://www.epa.gov/reg3hwmd/risk/human/rb-concentration\\_table/Generic\\_Tables/xls/params\\_sl\\_table\\_run\\_NOV2011.xls](http://www.epa.gov/reg3hwmd/risk/human/rb-concentration_table/Generic_Tables/xls/params_sl_table_run_NOV2011.xls)
- b Experimental values. EPA 2009. *Estimation Programs Interface Suite™ for Microsoft® Windows, v 4.00*. U.S EPA, Washington, DC, USA. Available online at: <http://www.epa.gov/opptintr/exposure/pubs/episuite.htm>
- f *CRC Handbook of Chemistry and Physics, 76th Edition*
- h EPA (2001). FACT SHEET *Correcting the Henry's Law Constant for Soil Temperature*. Attachment
- g National Institute of Standards and Technology (NIST). *Chemistry WebBook*. Available online at <http://webbook.nist.gov/chemistry/>

**Table C-2. Values of Exponent  $\eta$  as a Function of  $T_B/T_C$** 

Chemical-specific ratio $T_B/T_C$	H
< 0.57	0.30
0.57 - 0.71	$0.74 (T_B/T_C) - 0.116$
> 0.71	0.41